

Deluxe Adventure Set for Characters Levels 4 to 6

Advanced Dungeons & Dragons<sup>®</sup>  
2nd Edition

# Ravenloft<sup>®</sup>

Boxed Adventure Set

## CASTLES FORLORN

By Lisa Smedman



DANA NEWMAN '73



# Ravenloft®

Boxed Adventure Set



## The Weeping Land

Source Book





# THE WEEPING LAND

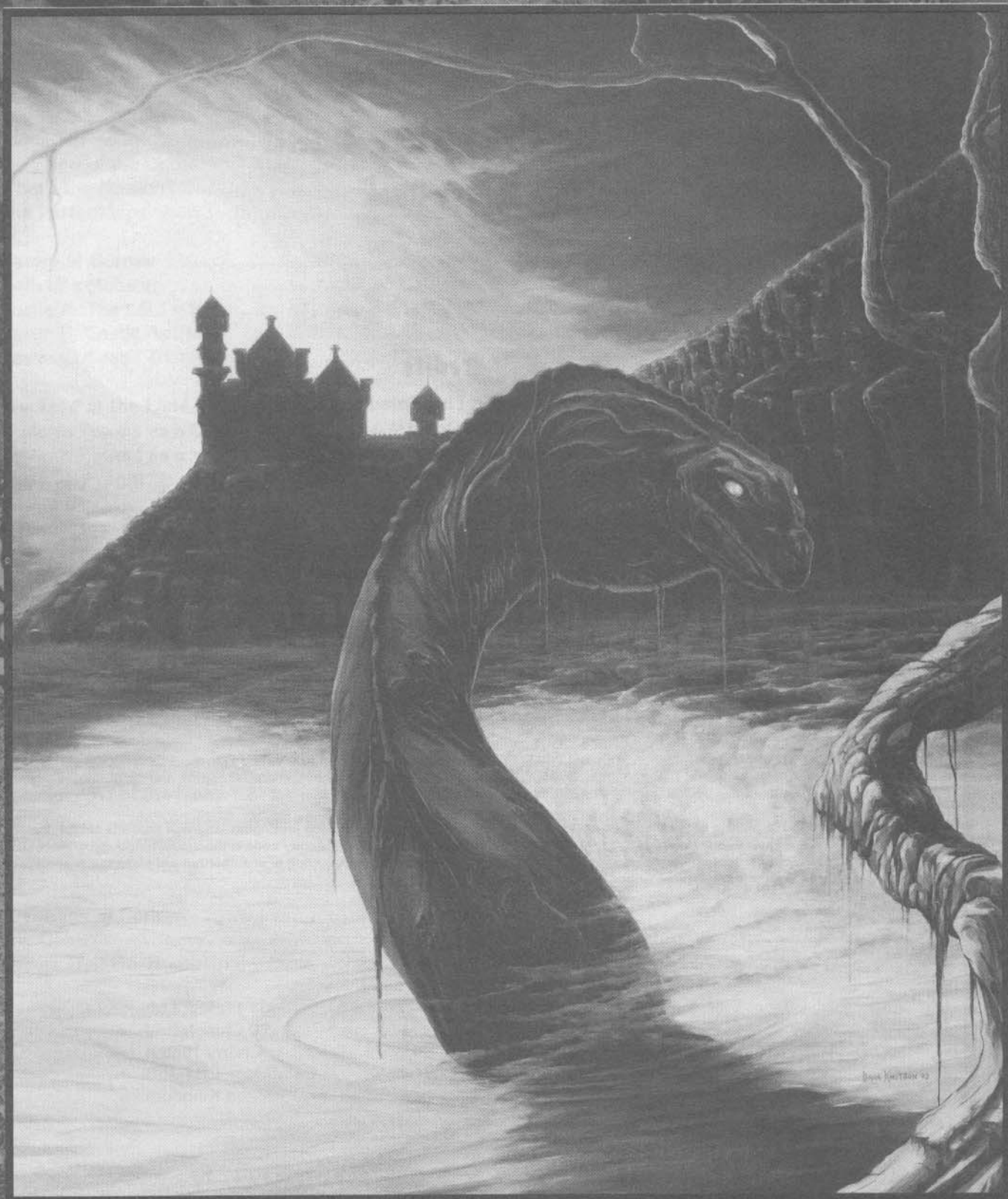

DAVID FLETCHER '92



# The Weeping Land

## Source Book

### Credits

**Designer:** Lisa Smedman

**Editor:** David Wise

**Project Coordinator:** Dori Jean Watry

**Graphics Coordinator:** Sarah Feggstad

**Art Coordinator:** Peggy Cooper

**Poster Artist:** Robh Ruppel

**Box Cover Artist:** Dana M. Knutson

**Interior Artists:** Stephen Fabian, Arnie Swekel, and Robert Klasnich

**Typography:** Angelika Lokotz

**Cartography:** David C. Sutherland III and Cynthia Felegy

ADVANCED DUNGEONS & DRAGONS, AD&D, and RAVENLOFT are registered trademarks owned by TSR, Inc. MONSTROUS COMPENDIUM, DUNGEON MASTER, DM, and the TSR logo are trademarks owned by TSR, Inc. All characters, character names, and the distinctive likenesses thereof are trademarks owned by TSR, Inc. ©1993 TSR, Inc. All Rights Reserved.

Random House and its affiliate companies have worldwide distribution rights in the book trade for English-language products of TSR, Inc. Distributed to the toy and hobby trade by regional distributors. Distributed to the book and hobby trade in the United Kingdom by TSR Ltd. This material is protected under the copyright laws of the United States of America. Any reproduction or unauthorized use of the material contained herein is prohibited without the express written consent of TSR, Inc.

TSR, Inc.  
POB 756  
Lake Geneva  
WI 53147  
U.S.A.



TSR Ltd.  
120 Church End  
Cherry Hinton  
Cambridge CB1 3LB  
United Kingdom



## Table of Contents

<b>Introduction</b> .....	4	The Wild Hunt .....	49
Overview of the Domain .....	4	What the Druids Know of Forlorn .....	51
What's the Mission? .....	4		
The Poster Maps .....	5	<b>VI: Casualties of Love</b> .....	<b>52</b>
<b>I: History of Sorrow</b> .....	<b>6</b>	<b>VII: Within Castle Tristenoira</b> .....	<b>66</b>
Birth of a Monster .....	6	Entering the Castle .....	66
Castle A: The Lord's Tower .....	11	From Time to Time .....	67
Castle B: Castle ApBlanc .....	14	Exploring the Castle .....	69
Castle C: Castle Tristenoira .....	15		
<b>II: The Lord of the Land</b> .....	<b>16</b>	<b>New Monsters</b>	
Tristen's Powers as a Ghost .....	16	'Aggie' .....	93
Tristen's Powers as a Vampyre .....	18	Death's Head Tree .....	94
Tristen By Night .....	18	Zombie Wolf .....	96
Tristen By Day .....	19		
Weaknesses .....	20	<b>Important NPCs</b>	
Current Sketch of the Lord .....	21	ApBlanc, Brangain .....	64
Confronting Tristen .....	23	ApBlanc, Flora .....	52
Closing Forlorn's Borders .....	23	ApBlanc, Gilan .....	60
		ApBlanc, Isolt .....	57
<b>III: The Land Forlorn</b> .....	<b>24</b>	ApBlanc, Morholt .....	62
The Blighted Forests .....	24	ApBlanc, Tristen .....	16
The 'Cleared Ground' .....	25	Herrd of Clan ApKie .....	36
The Sacred Groves .....	26	Maeave the Druid .....	42
The Lake of Red Tears .....	27	Rual the Druid Ghost .....	54
The Maw of Arawn .....	28	Shelaugh the Druid .....	41
The Caverns of the Dead .....	29	Wild Hunt, Master and Pack .....	50
Sanctuary .....	30		
The Ruins of Birnam .....	30	<b>Other Important Entries</b>	
The Road to the Castle .....	31	Spells Useless Against Ghosts .....	18, 52
		Tristen's Time Line .....	5
<b>IV: Denizens of Forlorn</b> .....	<b>32</b>		
The Goblins .....	32	<b>Tables</b>	
Things That Go 'Bump' in the Mists .....	38	1: Animal Encounters .....	39
		2: Vegetation Encounters .....	39
<b>V: The Druids—Nature's Last Hope</b> .....	<b>40</b>	3: Innate Redhead Abilities	
Spellcasting Abilities of Redheads .....	44	(1st level) .....	45
The Sacred Groves .....	46	4: Innate Redhead Abilities	
Gods of the Druids .....	47	(2nd level) .....	45



# INTRODUCTION



*e listened, but we only heard  
The feeble cheeping of a bird  
That starved upon its perch.  
And listening still, without a  
word,  
We set about our hopeless  
search.*

—Wilfred Wilson Gibson

Forlorn became a part of Ravenloft in the year 547 of the Barovian calendar. It was the second of the core domains to appear—only Barovia has been in Ravenloft longer. Unlike most other realms in the demiplane of dread, which

grew like tumors within the Shadow Plane, Forlorn was once a part of the Prime Material Plane. The lord of that accursed place, which was known as Forfar, proved so evil that his lands were literally ripped from their home world and cast into Ravenloft where the dark powers (whatever they—or perhaps it—may be) twisted and reshaped the land and people of Forlorn to suit their new, dark resting place.

Dire peril awaits those bold or foolish enough to seek the terrible secrets of Forlorn and its lord, whose name has remained unknown since he became a part of the grim elite of Ravenloft. Adventurers may count themselves very lucky if the master of this land does not note the tread of their feet upon his cursed soil.

Actually, few mortals visit the place of their own volition. Most come there when they step unsuspecting into a cloying mist, only to find themselves transported by some macabre magic into this foreboding and haunted land. Others, driven by some passion beyond the ken of normal mortals, may deliberately seek out this obscure region, but whether they do so in a search for gold and glory or to fulfill some evil design, only they can say. Forlorn's borders are said never to have closed, but neither have any met its ruler and reached the borders to tell their story, so the point is moot.

## Overview of the Domain

Compared to some of the lands of the core, Forlorn is quite small—just nine miles wide and seventeen miles long. Neighboring Barovia and Bluetspur seem huge in comparison, and even Kartakass to the west could easily swallow it twice over. On the whole, Forlorn might seem an almost insignificant part of Ravenloft.

Nothing could be further from the truth. Small though it may be, Forlorn is steeped in evil, from its ominous, cloudy skies to its blood-soaked soil. A foul taint permeates the air like the odor of mold in an old, damp cloak. And because Forlorn is so small a domain, its lord's reach is that much more immediate and oppressive. His minions are everywhere. In Forlorn, the land offers no quarter and few hiding places. Nowhere is it truly safe.

Among other creatures, Forlorn is populated by numerous ghosts who linger on, seeking to whisper in the ears of the living, telling tales of the black crimes committed against them. Hence, *Van Richten's Guide to Ghosts* (9355) will be very useful to the DUNGEON MASTER™ (DM™) when running a campaign in this domain, for that tome provides detailed information regarding incorporeal spirits in the RAVENLOFT® campaign environment, and this boxed set occasionally calls upon the rules included therein. (Sufficient information to run a game without *Van Richten's Guide to Ghosts* is included in this box, however.)

## What's the Mission?

*Castles Forlorn* is a freeform adventure; there's no order in which events must occur, nor are there specific goals that the PCs must accomplish. They need only enter Forlorn and then decide where to look for a challenge.

The *Melancholy Meetings* booklet sets short adventures throughout the domain—just play through the first encounter section and ask the PCs where they want to go next. Adventuring in the castles requires only a little more



# INTRODUCTION

preparation. The DM should look through the *Eve of Sorrows* booklet, choose enough encounters to keep the PCs busy all night, and then simply set them loose in the castles.

However, most PCs need an overall objective to keep them focused, so here's a few possibilities for the party to pursue:

- A henchman or other important NPC is "frozen" at the domain border (see "Closing Forlorn's Borders," page 23), and the PCs must figure out how to free their comrade (by becoming a real threat to the lord).
- A PC druid (or cleric) receives a vision from the god Diancecht, commanding the party to rescue a devout follower in the "haunted castles three" (the follower is Brangain ApBlanc—see page 64).

## The Poster Maps

There are two poster maps included in the *Castles Forlorn* boxed set. One of them is a detailed rendering of the entire domain.

There are several points in the *Melancholy Meetings* adventure booklet where an NPC offers to draw a map of Forlorn, at which time the DM can reveal the poster to the players.

The other map details all three Castles Forlorn. Rooms drawn in red mark Castle A, those in blue represent Castle B, and those in green delineate Castle C. To use the map, fold the map in half horizontally when showing it to the players: the tagged side faces the DM while the untagged side faces the players.

## Tristen's Time Line

The table presented here provides an at-a-glance listing of the major events in Tristen's life, providing dates as measured both by the old Forfar calendar and the Barovian calendar.

Event	Tristen's Age (& Apparent Age)	Forfar Calendar	Barovian Calendar
Tristen born; Flora, Rivalin die	infant	1594	n/a
Tristen kills Rual; Tristen turns vampyre	15 (15)	1609	n/a
Tristen burns grove	24 (15)	1618	n/a
ApFittles rule clan	43 (16)	1637	n/a
<i>Ravenloft</i> forms; Barovia appears	144 (21)	1738	351
Castle A built	215 (25)	1809	422
Tristen marries Isolt	219 (25)	1813	426
First son Gilan dies	232 (25)	1826	439
Second son Morholt dies	239 (26)	1833	446
Daughter Brangain imprisoned	244 (26)	1838	451
Isolt dies; Brangain disappears	245 (26)	1839	452
Tristen disappears	256 (27)	1850	463
Castle B built	315 (30)	1909	522
Last of the ApFittles dies; Forfar enters Ravenloft	340 (31)	1934	547
Castle C built	415 (35)	2009	622
PCs enter Forlorn	528 (40)	2122	735
Ruined castle	1030 (65)	2624	1237

## I: HISTORY OF SORROW



*aiden! A nameless life I lead,  
A nameless death I'll die!  
The fiend whose lantern lights  
the mead  
Were better mate than !!*

—Sir Walter Scott

None have ever seen the dreaded lord of Forlorn—at least, none have lived to recount their tales—and none have ever heard his name . . . until now: His name is Tristen ApBlanc.

Tales report the lord is not of this world, but is a ghost whose malevolent force has cursed the land. Other stories insist he maintains a mortal form. The truth is even more strange. Tristen is a vampyre (see the RAVENLOFT® appendix of the MONSTROUS COMPENDIUM™) by day and a ghost by night.

It has always been believed that the lord of Forlorn rules his domain from a crumbling fortress perched on the lip of a dangerous precipice, but that is only partially true. In fact, Castle Tristennoira (as it is called) exists simultaneously in *three* time periods, so Tristen lives in three versions of the same edifice.

The history of both the lord and his estate is long, sad, and bloody. . . .

### Birth of a Monster

**T**risten ApBlanc was born to a beautiful young noblewoman; she was brutally murdered by her own clan shortly after Tristen's birth. His father was a tormented vampire whose true love engendered an ageless curse and the second domain of Ravenloft.

The story begins in the spring of 1594, in a Prime Material highland realm called Forfar, which was ruled by the respected and wealthy Clan ApBlanc from the town of Birnam. The young Lady Flora ApBlanc had fallen in love with the dashing, raven-haired Rivalin ApTosh,

and clanspeople throughout Forfar toasted the fortunes of the future baron and baroness.

That same spring, Rivalin rode off to join a war against a lowland clan to the east. Back in Birnam, Lady ApBlanc and the druidic order of priests who served the people of Forfar prayed ardently for his safe return. Meanwhile, Rivalin fought heroically and single-handedly felled the chief of the lowland clan, spurring the highlanders to victory. Torrential storms, called forth by the druids, drove the lowlanders blindly before their conquerors, and Rivalin led the rout.

There was much confusion in the tempest, though, and many soldiers died on both sides. Tragically, Rivalin was struck by a stray arrow shot by a lowlander in retreat, and he fell in deep mud, unnoticed by his fellows. Later, when the soldiers of Forfar returned without the dark-haired hero and reported him missing, the druids could only pray for his soul. Flora wept bitterly, for the child in her womb would never meet its father—or so she believed.

### Life, Unlife

Several weeks later, Rivalin was spotted in Birnam late one storm-swept night. The half-mad townsman who saw him claimed that the soldier bore pale white scars of grievous wounds, that his eyes were wild and his bearing furtive. Upon hearing the news of her lover's return the next morning, Flora rushed to the town square where he had been spotted, but the night seemed to have swallowed Rivalin without trace.

Flora could accept nothing less than the triumphant return of Rivalin, and her growing obsession soon convinced her family that she had gone mad. Her parents locked Flora in her bedchambers at night, but she repeatedly escaped and continued the search for her missing lover. Eventually, late one night, she found him, and the discovery proved bittersweet to the edge of lunacy. Fear and loathing filled her to the marrow when she heard his terrible news.

Rivalin had lain in the mud of the battlefield that day, hovering on the brink of death, until



## I: HISTORY OF SORROW

dusk descended. Hidden as he was by the muck of blood and rain, the warrior was overlooked by soldiers who came to collect the bodies of fallen comrades. Then, with the close of day came those that feed upon the dead—and upon those about to die. Thus the last of Rivalin's life force was drained away by a vampire. Two nights later, Rivalin arose with his own, aching thirst for blood. . . .

At first Flora recoiled in horror as Rivalin recounted his tale, but such was her love that she stayed by his side that night—and through many long nights that followed. Gently laying a hand on her swollen belly, she said, "As long as this child lives, you are not truly dead."

### Love Dies Bleeding

Even though the curse of vampirism had fallen upon Rivalin, his true love for Flora pierced the boundaries of death and corruption, leaving him a feeble grip upon the goodness that had once been so much a part of him. For a while, the vampire was able to resist the unnatural inclinations of the undead. Initially, Rivalin hid from the world of mortals. By day he slept in an abandoned hut deep in the woods, and by night he hunted animals, satisfying his gruesome cravings with the blood of lesser creatures.

But in time, Evil enshrouds virtually all whom death has embraced yet left behind—Rivalin began to feed upon human blood, and Flora was his first victim. While she slept in his arms, he supped gently upon her blood, believing he was causing no harm. Indeed, she seemed to suffer no ill effects from repeated feedings. However, the unborn child in Flora's womb was steadily assimilating vampiric toxins that Rivalin's saliva injected into Flora's bloodstream. Supposedly secure within its mother, the fetus contracted a disease that would eventually turn him into a vampire!

Later, when a sip of Flora's blood could no longer satiate Rivalin, he began to prey upon the people of Birnam. As the list of the dead grew, the highland clan chiefs realized that an evil presence was lurking in the heart of the land.



# I: HISTORY OF SORROW

Together they organized a hunt, and a bloody trail that Rivalin had done little to conceal led straight to his hiding place. Only an untested fledgling vampire, Rivalin would prove relatively easy to kill.

Upon learning that vampire hunters stalked the forest, Flora flew to her father and pleaded with him to spare her lover. To her sorrow, Baron ApBlanc was appalled that his daughter would embrace such an abomination, and he vowed to put an end to the undead monster that had “stolen his daughter from him.” Desperate, Flora turned to the gods, praying for mercy upon Rivalin, but the gods her people worshiped were druidic deities of nature and light—Flora’s prayers fell upon closed ears.

## Mob Justice

When the vampire hunters returned and displayed the decapitated body of Rivalin, Flora wailed pitifully and threw herself upon the corpse. The townsfolk of Birnam, looking on, quickly drew a connection between Flora’s adoration of the cadaver and her swollen belly. Soon there were murmurs of an evil seed in her womb. Even her parents, the Baron and Baroness of Forfar, were unable to stop the wagging tongues. They loved their child, but they, too, believed she was tainted.

Flora’s baby was born in the chilly winter of 1594. She named him Tristen the Fair. Like Flora, the child had hair pale as straw, and she hoped the lack of resemblance between the boy and his father would lay the people’s fears to rest. “Tristen’s blood is not tainted,” she insisted, urgently pointing out that the boy had no fangs and that his chubby flesh was warm and pink, not deathly cold like Rivalin’s.

But among the simple and righteous, fear runs as deep and dark as a river under thin ice; hatred keeps a fool warm in a cold world. So it was that the people of Birnam battered down the doors of ApBlanc Hall one night and rushed the child with murder in their hearts, seeking to drive a stake through his own.

Their search was noisy, though, and Flora escaped with the baby Tristen in her arms. Pursued by the howling mob, she ran through the village and into the dark forest, then blindly up the hill to a sacred grove of the druids. There, a young druid named Rual was meditating within the circle of blessed trees. Flora pushed the baby into the druid’s hands and begged her to hide the child.

As Rual slipped into the night, Flora turned to slow the mob. “I beseech you!” she implored. “Tristen is just a baby! He cannot harm you!” But the mob included some who had lost family members to Rivalin’s fangs. Enraged with fear and caught up in the moment, they forgot her noble status and ignored her pleas.

“Don’t listen to her!” one of them shouted. “She’s the one who brought this evil into the land! Kill her before she spawns more demons!”

In the name of the gods, they cinched a coarse rope around Flora’s neck and gleefully hung her from the branch of a sacred oak tree.

## Sanctuary

At dawn the next morning, the druids cut Flora’s body down, prayed for her, and then buried her. To correct the imbalance of good and evil that manifested when Flora was unjustly murdered, they decided that Rual should raise Tristen so he could right the wrong his mother suffered. To the mob that clamored for the child’s blood, the priests explained that the Archdruid would determine the fate of Tristen and they should trouble themselves with him no more. Reluctantly, the people of Birnam let the incident fade into the past.

Under the care of Rual, Tristen grew into an exceedingly handsome young man. Charming and intelligent, he excelled at anything he was taught. Rual instructed him in all of the courtly arts, from horsemanship to music to fencing to chess. One day, the druid believed, Tristen would return to the ApBlanc clan and be acknowledged as the grandson of the aged baron and baroness. He would then make his



# I: HISTORY OF SORROW

claim as the rightful chief of Clan ApBlanc, but until that day he would remain a nameless boy, a servant to the druids of the sacred grove.

## From Rotten Acorns . . .

In spite of these grand plans to restore Tristen to glory, Rual wisely recalled and considered the love affair that had existed between human and vampire, and a sliver of doubt remained in her heart. On the day the druids recovered Flora's corpse, Rual had noticed a multitude of healed-over punctures in her wrists. Although Tristen showed no sign of his father's curse, the druid knew better than to assume that all was as it should be. Rual dared not create a monster skilled in the druidic arts, so she refused to teach Tristen her ways, no matter how often he begged for instruction.

One dark night in the year 1609, when Tristen had reached his midteens, Rual's fears were realized. By the light of a baleful moon, she spied him in the woods, bent over the corpse of a young doe. She thought at first that he had been hunting, but when the boy arose from the body of the animal with a crimson-smeared face, Rual knew the boy's paternity was at last telling true. The toxins in Tristen's body were finally changing him into a vampire.

## The Monster Emerges

Perhaps Tristen heard Rual's sharp intake of breath as she watched him sup upon the life of the deer. Perhaps his vampiric senses were sharpening, and he smelled her blood. In any case, Tristen realized his shameful secret had been discovered. At first he hoped to persuade Rual to keep his secret, but when he spied her talking in whispers with other druids the next morning, he feared the worst. Well aware of the fates that had befallen his mother and father, he resolved to act.

That evening, as the sun set, Tristen crept up on Rual while she meditated over a blessed antler in the sacred grove, below the very tree in

which Flora ApBlanc had been hung. With a deathly silent spring he was upon her, but Rual reflexively turned and drove the point of the antler into Tristen's chest, inflicting the most excruciating pain he had ever experienced. The emerging monster uttered a blood-chilling howl of agony as he pushed the point back and overpowered her, pinning her arms to her sides. Then, his eye teeth lengthened to deadly points, he sank his fangs into Rual's neck, drinking deeply of her blood as his own drained from the antler wound and washed over her. Rual's blood was the first human life's essence that Tristen had ever tasted, and it flowed through his veins with an intoxicating thrill.

## Blood Enemies

There is a balance in the life of druids that affects all who touch them, and so it was that Rual's murder wrought an equal and opposite reaction upon her murderer. Before coming to meditate in the sacred grove upon the question of what course of action to take with Tristen, Rual had purified herself by drinking holy water. The sacred liquid was coursing through her veins even at the moment Tristen struck.

Tristen didn't notice at first the honey-sweet taint of Rual's purified blood—for all he knew, that was how all human blood tasted. Then, pain far worse than that which he had felt at the tip of the blessed antler racked him to near unconsciousness, and he realized that Rual's blood was somehow poisonous to him. Until that moment, Tristen was certain that his father's blood had bestowed immortality upon him. Now, suddenly, he was dying—he who had not yet lived even a score of years!

Enraged, Tristen tore savagely at Rual's body, ripping it open with his sharp nails, pounding her with his fists until her body went limp, screaming in pain and rage all the while. With a hiss, the young monster leaned over the druid and prepared to finish his deadly work.

As she lay dying, her life flowing into the sacred grove, Rual cursed Tristen: "I was going

## I: HISTORY OF SORROW

to heal you, bring you back into the light," she whispered through bubbling lips. "*But now I curse you!* With my dying breath, I beseech the gods to make you an eternal prisoner of this place, which you have stained with evil! Let murder burn in your veins with every setting of the sun, and may peace never come to you!"

### Forlorn Forever

Ironically, the draining of Tristen's blood while he simultaneously assimilated Rual's, infused with holy water, amounted to a transfusion that washed away the tainted poison which would have eventually turned him into a full vampire. The process was excruciatingly painful to Tristen, leading him to believe he was dying, but it was actually affecting a cure.

Nevertheless, Rual set in motion the blurring of planar borders that would eventually draw Tristen and the surrounding lands into the demiplane of dread. Covered with unholy blood

and outraged to the point of insanity by the murderous betrayal of her adopted child, the druid deprived Tristen of his cure and poisoned him again, this time with her deadly curse. As Rual laid her malediction upon Tristen, the sun sank below the horizon and her blood began to boil within his body. He fell to the ground and thrashed convulsively, screaming until his veins burst within him, and then he died.

But death is a relative term among the cursed, and it was certainly not the end of Tristen. He arose as a ghost that same night, and he discovered that he could not leave the sacred grove where Rual's body and his own lay. Tortured by the sight of those bodies, he ranted hysterically and crawled along the border of the sacred grove, seeking any way to escape his horror, filling the air with a piteous moaning.

With the rising of the sun, Tristen half expected and fully hoped that he would be destroyed by the purifying rays of daylight. Instead, he was irresistibly drawn back into his





## I: HISTORY OF SORROW

body and he rose, not as a vampire, but as a *vampyre*—a living blood drinker!

In a panic, Tristen immediately sought to flee the sacred grove, but he quickly discovered that he was still trapped there, even in corporeal form. The sacred trees all seemed to spread their branches as if they would hold him back, and an invisible wall bound him within the perimeter of the grove. At sunset, his blood began to boil again, killing him in searing agony, and so it has been since that day.

Each and every evening, as the sun sinks below the horizon, Tristen dies in horrible pain and rises as a ghost. With the coming of dawn, his body waits for him and he must live out his days as a vampyre. (One highly respected sage has speculated that he is the very *first* vampyre.) Tristen is immortal and takes great satisfaction from that, yet he also dies in torment every day and can never escape the site of his curse.

Needless to say, the once-sacred grove at the heart of the land of Forfar shortly became well known to be haunted. Some attributed this haunting to Rual's savage murder, others to Flora's hanging, but none realized the true source of the evil that now enshrouded the hillside. The druidic order forsook the grove and it became a place of desolation and shadow. At night it echoed with howls—of wolves according to some and of something unspeakable by others' reports. A few brave adventurers ventured into the grove in search of its dark secrets. None returned.

### Purification by Fire

One windy day in 1618, Tristen attempted to free himself of the curse that chained him to the sacred grove by setting the woods aflame. The blaze, fueled by evil on the wind, swept through the grove and then spread to Birnam, reducing the once-proud trees to blackened skeletons and burning half the town to ashes. As the fire burned on, there was no doubt that something besides a wolf was baying in the woods. The screams of torment that tangled with the roar of

the forest fire sounded human, but they lasted an inhumanly long time.

An especially eerie detail about that night was that one tree escaped the conflagration: the old oak in which Flora ApBlanc had been hung and under which Rual and Tristen had died. The tree remained so clearly untouched by the inferno that it appeared to have been planted after the fire burned out.

After the fire of 1618, wolves began to course across the land in frightening numbers, becoming a plague upon the land. So aggressive were the attacks of these beasts that some people were attacked even in broad daylight, just outside of Birnam. Hunters were sent out to kill the beasts, but for every wolf they killed, a dozen more appeared, seemingly springing up from the land itself. Adding to the terror, some of these wolves seemed already dead—they walked with slow, jerky motions and were apparently impervious to attack. In time, hunters learned to take a priest along when they went hunting, and the plague of wolves (both alive and undead) was reduced, but it was never wiped out entirely.

### Time's Balm

As the years slipped by, new saplings sprang up in the charred remains of the old forest and grew into mighty trees, dwarfed only by the old oak in the sacred grove. Meanwhile, the people of Forfar aged. Baron and Baroness ApBlanc died without an heir in 1637, leaving the stewardship of the clan to one of its most powerful families, the ApFittles. One by one, those who had once hunted down Rivalin, participated in Flora's murder, or worshiped in the holy grove died of old age.

### Castle A: The Lord's Tower

Two centuries after Rual's death, in 1809, a young minstrel appeared on the site of the sacred grove and laid claim to the holdings of Clan ApBlanc. He announced that he would

# I: HISTORY OF SORROW

build an estate there and promised not to leave until it was completed.

The man claimed to be a distant cousin of the ApBlancs of Birnam, but he was none other than Tristen himself. For two centuries he had been amassing a fortune, carefully stockpiling the gold and valuables of those whom his wolf minions waylaid and dragged to the grove for him to feed upon. In time he had accrued enough wealth to build a permanent and regal home on that accursed spot.

After establishing his "heritage," Tristen recruited the services of local stonemasons and carpenters, who erected his new home that summer. The minstrel instructed his workers to eradicate every tree within 50 feet of the building site, except the old oak, which would remain just outside the front door. The estate was of a grand design—a full-sized keep—and would easily rival the home of the ApFittles (the former ApBlanc Hall) in the valley below.

## Cloak of Mystery

None who worked on the keep ever questioned the young minstrel about where his fortune came from. Nor did they understand why he chose to build a home on a site that was known to be haunted, why he never left the area himself, or why he insisted upon destroying every tree except the oak. However, the reason for the lack of curiosity was well understood: One day, a team master complained that his horses would be worked to death pulling all the tree stumps from the hillside. Without a word, ApBlanc slew the horses with two swift strokes of his sword, then purchased two new horses for the man, who never griped again. Since the young minstrel had money aplenty to pay for his whims, yet not a whit of patience to justify them, no one asked questions.

Curiously, *no one* could remember the young man's first name, although all were certain they knew it. Each worker and villager, it seemed, knew the young man by a different name, and all were certain that only they had the correct

one. By silent consensus, they called him "Lord ApBlanc" or "the young minstrel."

The fact that Tristen was only a vampire allowed him to assert his apparent mortality to those who might be skeptical. Tristen also went to extremes to make it known that he was very much a "day person." He ascribed his nocturnal disappearances to night-blindness and a delicate constitution that required more sleep than average. Hence, he always called for his workers and guests to leave the area well before sunset, and no one thought it strange.

## A Marriage of Inconvenience

When the keep was completed, Lord ApBlanc began to entertain. He was noted for his hospitality, his lively conversation, his mastery of music and chess, his courtly manners, and his comeliness. Tristen's gift for verse and song, his cultured ways, and his incredible physical magnetism attracted the attention of many young women of Birnam, but only one of the town's maidens caught his eye—Isolt, a young beauty who devoted herself to the worship of Diancecht, the healing god. Ironically, of all of the women of Birnam, Isolt was the only one who showed no interest in the eligible bachelor. She was a talented healer and midwife, and she was extremely devoted to her clerical calling, so the villagers were sure that Isolt would never receive the young minstrel's overtures. Hence, Tristen's reputation as a romantic swelled to mythical proportions when he somehow persuaded Isolt to marry him.

The wedding took place in the year 1813 and was a festive affair. Isolt was noted to have been crying that day, but the villagers believed they saw only tears of joy.

After that day of celebration, Lord ApBlanc no longer entertained in his keep, and the couple lived there attended only by servants and retainers. Some thought that attendants of the good Isolt should be more genteel and friendly than was the staff of the keep, but the rough, secretive lot that attended Lord and Lady



# I: HISTORY OF SORROW

ApBlanc kept both strangers and relatives from frequenting the estate. The staff also included a small group of gardeners who worked ceaselessly to weed out any saplings that sprang up; Lord ApBlanc insisted that the grounds should always be kept clear.

At first it seemed to all that the young couple would prosper—two sons and a daughter were born to them. Unfortunately, instead of increasing the happiness of Tristen and Isolt, the children proved a source of great conflict. Isolt wanted the children to follow her faith, but her husband adamantly refused to allow them to be educated under any religious training.

As time wore on, the couple's relationship became characterized by a cool formality rather than romance and passion, which most expected from the handsome poet-minstrel and his lovely wife. Privately, many young women blamed "prudish Isolt" for cooling Lord ApBlanc's flames, and cursed their luck at not having him themselves.

## Horror At Home

With the departure of domestic bliss at ApBlanc Hall, sorrow and tragedy set upon the family. The firstborn son, Gilan, lived only to age 12; in the year 1826, he was torn apart by wolves. The second son, Morholt, was only 18 years of age when he was slain by an assassin, in the year 1833. And the youngest child, Brangain—a worshiper of Diancecht, like her mother—mysteriously disappeared in 1838, at age 22. Witnesses claimed she was carried away by a vile, misshapen creature.

In fact, Tristen was responsible, directly or indirectly, for the deaths of both his sons and for the disappearance of his daughter as well. The first death might never have happened, had Tristen not set his wolf minions upon the boy's dog. Gilan died trying to protect his beloved pet. Morholt, however, died by Tristen's own hand. A young cleric friend of Morholt's was spending an overnight visit at the keep, and Lord ApBlanc perceived him as a threat. Little did Tristen

realize that his son, raised to be chivalrous, had given his own, more comfortable bed to his guest and taken the lumpy bed in the spare room. As the sun crested the horizon the next morning, Tristen came upon the lump in the guest bed and cleaved it in half with his sword. Morholt never knew what hit him, never awakened as his entrails slipped from their resting place and unraveled onto the floor of the guest room.

Brangain, on the other hand, did not die at all, but was imprisoned by her father in the dungeons below the castle when she refused to renounce her mother's faith. For one year she was a prisoner in her own home. Not even Isolt knew that her daughter lay languishing in a dark and almost airless cell. Then, one day in 1839, Brangain mysteriously vanished from her prison. Not even Tristen knows how she escaped or where she went.

In that same year, the greatest tragedy of all occurred. Isolt, devastated by the loss of her children, apparently committed suicide. That was the report of Lord ApBlanc, who found her broken body below the high balcony of the Lord's Tower. The clerics who came to collect her body for burial agreed that she had fallen to her death, but they were reluctant to speculate upon the myriad puncture wounds that covered her body. Tristen claimed that she had been cut up as she fell through the branches of the old oak tree on her way down, and they accepted the explanation under his steely gaze.

## Ghost Stories

Death also stalked the servants of the keep. One by one, most of them fell victim to unfortunate, horrifying accidents. Others suffered from a strange wasting disease. Still others fled, thinking a curse had come upon the estate. And some of them simply disappeared without a trace.

There had *always* been rumors that the castle was haunted—strange stories of incorporeal creatures were legendary among the natives of Forfar. The ApBlanc family, strange to outsiders

# I: HISTORY OF SORROW

from the beginning, was reputed to live in quiet harmony with a multitude of ghosts. However, with the disappearance of the family members and so many servants, not to mention travelers in the Forfar area, the unliving residents of the Lord's Tower gained a reputation for malevolence.

For perhaps a decade after his wife's death, the young minstrel lived by himself in the keep, and the halls echoed with his footsteps alone. By the year 1850, Tristen had disappeared, too. Some said the young minstrel eventually chose to follow his wife into death, that he too committed suicide. Others said he simply moved away from that mournful place.

## Changing Times

Castle ApBlanc lay abandoned for more than 50 years. There were a few who tried to steal its treasures, but they disappeared or met with gruesome ends. The forest grew back and the abandoned keep—rumored now to be cursed—fell into neglect.

Throughout the latter half of the 1800s, Forfar became ever more dangerous. The land itself seemed to have acquired a curse. Sightings of ghosts began to increase, as did the cruelty of those undead spirits. As the century drew to a close, there were rumors that, in some parts of the land, household pets were transforming into hideous, slaving caricatures of their former selves. Other villages produced wild tales of shadows that slithered out of darkened corners to sink their fangs into sleeping victims. For the most part, people were able to continue with their lives, and travelers still visited the area, but they kept their weapons close at hand when night fell.

## Castle B: Castle ApBlanc

In the Forfar year of 1906, a light was spotted in a window of the abandoned Lord's Tower. Those brave enough to investigate found that a man about 30 years old had come to claim the inheritance that his "great-grandfather" had left

him. The man, who gave his name as Marc, bore a striking resemblance to his ancestor, the minstrel ApBlanc, and he made a documented legal claim to the property, producing irrefutable proof that he was a true descendant of the ApBlancs of Forfar. His papers proved he was a grandson of Brangain ApBlanc, whom he said had fled to a neighboring country in 1839 to escape her father's wrath.

In fact, the young man was none other than Tristen, who had resurfaced after five decades of brooding in the castle dungeons.

Marc's first demand was simple: that the ApFittles allow him to improve and live in the keep. The ruling family agreed reluctantly, for the proposed plans were that of a castle befitting a king, and they grew suspicious.

Once again trees were felled and once again there was a flurry of activity upon the hill. A grand hall and guest tower were added to the original keep and the new Lord ApBlanc settled in to his refurbished home.

## The Claw of Power Closes

Marc then recruited a small band of loyal followers, many of whom were rough mercenaries from other lands. Some of the villagers of Birnam whispered that these were actually wanton criminals, bought out of prison by Marc's coin. While these brutes stood guard, construction workers began to expand the existing structures into a full castle fortified by great walls. The ApFittles protested the addition of walls, and they even sent a troop of soldiers up the hill to put a halt to the construction—by force, if necessary. Marc's men slaughtered them without parlay and their blood was added to the mortar.

The ApFittles were enraged, but they had precious little resources to devote to enforcing their will upon ApBlanc. There were new wars with the lowland clans to attend to, and within the land itself there were strange and terrible new monsters to battle.

In fact, Forfar had always had its share of monsters, but the greatest influx of evil ever



# I: HISTORY OF SORROW

occurred in the three years that immediately followed Marc's arrival. In that brief space of time, the once-bountiful Forfar became a land shunned by travelers. The new horrors included strange creatures that appeared to be a hideous confusion of human and animal parts. They shambled along on broken, twisted bodies and carried away any who dared venture out after dark. There also was a new breed of wolves terrorizing the land. As large as ponies, they seemed as intelligent as humans. Some said these evil worgs had a language of their own. Even the forests of Forfar, once green and bounteous, began to show a darker side. There were rumors of evil, animated trees that caught unwary travelers within their branches and then devoured them in gaping mouths.

The greatest concentration of monstrosities seemed to be around the once-sacred hill which now was home to Marc's growing castle. The villagers of Birnam began to suspect Marc, saying he was cursed to draw evil to him.

As their soldiers dealt with the monsters and lowland clans, the ApFittles grudgingly allowed Marc to finish expanding his home. The construction proceeded throughout the year of 1909, and by the end of that year a full-fledged castle, complete with walls and battlements, stood on the site of what had once been the sacred grove.

By the 1920s, Marc was strong enough to make another demand: He called for an end to the rule of the ApFittle family and his installation as baron of Forfar. Now the ApFittles fought back, but Marc's forces had grown in number and ferocity. Civil war simmered, coming to a boil in the late 1920s. Despite an ApFittle siege, Marc's forces eventually triumphed and the surviving members of the ApFittle family were marched off to the dungeons of Castle ApBlanc.

## The Seal of Fate

The last of the ApFittles, a paladin named Andrew, was tortured and then executed in 1934. With the violent elimination of the last of

his ApFittle rivals, Marc declared himself the absolute lord of his domain, and the dark powers of Ravenloft obliged him. The gloating Baron ApBlanc proclaimed his true identity and prepared to rule Forfar with an iron fist, but it was not to be. Little did the new lord realize that his deeds were slowly and inexorably drawing the land to its doom.

Overnight, Forfar was physically wrenched from the Prime Material Plane and thrust into Ravenloft. The land itself was reshaped beyond recognition, and the same fate befell its people. They became goblins, twisted mockeries of what they once were.

The first Barovian explorers to venture into the domain that had suddenly come into existence unwittingly gave it a new name to scorn its old: *Forlorn*. Likewise, they gave a name of cold coincidence to the castle that dominates it: *Tristenoira*. In the Barovian language, the word means "eve of sorrows," but the name might just as well have been the lord's epithet: Tristen the Dark.

Thus the second realm in the demiplane of dread took its place in the shadows.

## Castle C: Castle Tristenoira

**T**risten took seven decades to exert control over the goblins and make them his minions. When at last he succeeded in dominating them completely, he employed them to expand his castle once more. Again, the project began on the anniversary of Rual's death, this time in the year 2009.

To further commemorate the death of the woman whose curse had forever bound him in that castle, Tristen launched a campaign of terror against the handful of people who had managed to maintain their human form—the druids. Tristen had come to believe that he would be free of Rual's curse if he could eliminate the last of the worshipers of those gods that once watched over Forfar.

For now, however, Tristen remains trapped in his castle and his struggle with the remnants of the druidic order continues.

## II: THE LORD OF THE LAND



*took that hand which lay so still,  
Alas! My own was full as  
chill . . .  
I know not why I could not die.*  
—Lord Byron

Tristen exists as two separate creatures, but he is not to be confused with a lycanthrope. Lycanthropes either have control over their transformation or they become unthinking beasts when the change comes upon them uninvited. Tristen has no control over the change, yet he remains in complete control of his faculties while in either form. Also, lycanthropes change from human to beast and back while Tristen vacillates between a ghost and a vampyre.

### ApBlanc, Tristen

Lord of Forlorn

11 HD Ghost/Vampyre, Neutral Evil

Armor Class	0	Str	18/76
Movement	9 (ghost),	Dex	16
Movement	12 (vampyre)	Con	12
Level/Hit Dice	11	Int	16
Hit Points	88	Wis	8
THACO	11	Cha	19
No. of Attacks	1 (ghost) or 3 (vampyre)		
Damage/Attack	age 1d4×20 years (ghost) 1d4/1d4/1d6 (vampyre)		
Special Attacks	see below		
Special Defenses	see below		
Magic Resistance	40% (ghost), special (vampyre)		

As a lord of Ravenloft, Tristen constitutes a *sinkhole of evil*. Hence, a penalty of -2 should be applied to fear and horror checks in his presence, and to priestly turning attempts, *if he can be turned at all* (see "Weaknesses," page 20). This sinkhole effect spans the castle, so all undead therein are turned with a -2 penalty.

### Tristen's Powers as a Ghost

Tristen has a number of abilities that are linked to the manner in which he became a ghost. His hatred and fear of his own mortality have given him the ability to *accelerate aging* in mortals who look into his eyes, even for a moment (1d4×20 years; treat as a *gaze* attack [see the *DUNGEON MASTER™ Guide*]). Priests of 11th level or higher are immune to this effect. All other classes of 13th level or higher gain a +2 bonus to their saving throws. Tristen's sorrow over the murders of Rual and his family has given him the ability to *keen* twice per night (40-foot radius of effect, -1 penalty to a saving throw vs. death). His ghastly appearance can *cause revulsion* in those whom he touches (successfully save vs. paralysis or suffer a -6 penalty to all attack rolls, saving throws, and proficiency checks for one week). Priestly healing spells will cancel these effects. Finally, Tristen's thirst for power has endowed him with the ability to *dominate victims*, sliding into the bodies of sleeping persons to control their actions (successfully save vs. paralysis with a -2 penalty to resist). This domination ends just before dawn, when Tristen must slip from the dominated body and transform into vampyre form. Note that priestly attempts to turn him, if they are possible at all, are made with a -4 penalty, including the sinkhole effect described above.

As a ghost, Tristen may be struck only by weapons of +3 enchantment or higher, but an opponent who is also incorporeal need only possess a weapon of +1 enchantment. Tristen also has the ability to rejuvenate himself to full hit points at any time by absorbing the essence of the Border Ethereal Plane. This process takes one round and renders him incapable of performing any action for 2 turns. (Before rejuvenating, Tristen will seek out a safe place in which to rest.)

Tristen's appearance is such that the PCs' first encounter with him is cause for a horror check, and the first time they witness any special ability, they are subject to a fear check.



## II: THE LORD OF THE LAND



## II: THE LORD OF THE LAND

### Tristen's Powers as a Vampyre

**T**risten's main trait as a vampyre is his ability to *charm* (as the spell) victims of his bite. The injection of his saliva into the veins of a humanoid requires a saving throw vs. poison, modified by -1 for every 2 points of damage inflicted by his bite, plus a -2 penalty due to his status as a sinkhole of evil. If Tristen inflicts 3 points of damage, the PC must save with a -3 penalty to avoid becoming *charmed*.

Tristen was a vampyre of *fledgling* status (see *Van Richten's Guide to Vampires*) when Rual's curse changed him to a vampyre, and he retains a few vampiric abilities. He receives a +2 attack bonus and a +4 damage bonus, due to his unnaturally high Strength. Weapons of at least +1 enchantment are required to hit him. He also can summon 3d6 wolves or worgs (DM's choice) three times per day. They arrive in 1d6 rounds and remain under his control for 2d4 rounds (remaining in the area, free-willed, when the duration of control expires). Finally, he can take the form of a worg at will. While changing his AC drops to 5 (for one round) and he suffers a -1 penalty to saving throws. Once per day, shapeshifting restores full hit points.

**Worg form:** AC 2; MV 18; #AT 1; Dmg 3d12; SZ L; ML 16; other stats are as a vampyre.

In this form, Tristen cannot charm with his eyes, drain experience levels with his cursed touch, or regenerate hit points.

### Tristen By Night

**W**hen the sun sets, Tristen suffers an agonizing change from corporeal to incorporeal form and becomes a ghost. His recurring nocturnal death, which occurred when he drank the sanctified blood of Rual and received her dying curse, was an event of great emotional stress and psychic energy. Not only did Tristen think he was dying, but he knew that he was murdering the only mother he had ever known.

He also was killing the only person who might have the ability to cure him of his vampirism.

A tragedy of such resonance occurs only once every few centuries, and it turned Tristen into a ghost of the *fourth magnitude*. The powers and weaknesses of ghosts of all magnitudes are detailed in *Van Richten's Guide to Ghosts*, but a quick summary of Tristen's status as a fourth-magnitude ghost is presented here. (All game effects of this ghostly status are accounted for in the text as well.)

Tristen ApBlanc is an incorporeal, humanoid, corrupted spirit. As a "corrupted" spirit, the apparently teenaged male ghost's skin is bloated with dark veins that show quite clearly. His hair is matted, his clothing torn and dirty, and bloodstains mark the front of his chest and the plain druidic kilt he wears. In other words, his appearance reflects the corpse which Tristen might have become had he died the night he attacked Rual in the sacred grove. He also shows signs of having been burned by the fire he set in 1618, with patches of exposed scalp, soot on his skin, and partially burned clothing. In the right light, he even appears to smolder, as if his ghostly form is evaporating.

Because he is incorporeal, Tristen can pass through walls, floors, furniture, and other solid objects. Likewise, most material objects pass right through him. Tristen also has the ability to become invisible at will, and he is immune to all spells that affect biological processes.

#### Wizard spells that are useless vs. ghosts:

*Avoidance, blindness, cloudkill, contagion, deafness, death, death fog, energy drain, finger of death, haste, hold animal, hold monster, hold person, irritation, magic jar, Otto's irresistible dance, polymorph any object, polymorph others, power word blind, power word kill, power word stun, sink, sleep, slow, vampiric touch.*

**Priest spells that are useless vs. ghosts:** *Animal growth, cause blindness, cause deafness, cause disease, hold animal, hold person, regenerate, restoration, speak with monsters.*



## II: THE LORD OF THE LAND

A special exception to this rule in Tristen's case is that a *cure wounds* spell of any level affects him as a *cause wounds* spell of the same level, but *only when cast by a cleric of the Celtic god Diancecht*. This effect is more psychological than magical, for Tristen's wife and daughter were both priestesses of Diancecht.

Tristen is anchored to the castle area and can never move more than 100 feet away from the old oak tree under which he killed Rual (see "The Sacred Oak," page 21).

*Van Richten's Guide to Ghosts* contains some interesting effects and applications of magical spells upon ghosts; the Dungeon Master is encouraged to consult that resource for richer role-playing of the lord of Forlorn.

### Tristen By Day

As the sun rises each morning, Tristen magically assumes a corporeal form, that of a vampyre. Although he is 528 years old when the PCs enter his domain (year 2122 on the Forfar calendar), Tristen appears to be a man in his early 40s because he ages apparently only five years in each century of his life.

Tristen was born with the yellow-blond hair that is a trademark of the ApBlanc clan. By the time he reached his teens, its color had darkened to a light brown shade. By the time he resembled a man in his early 30s, Tristen's hair was receding at the temples. Now, at the apparent age of 40 years, his hair is thin and peppered with gray. Tristen still cuts a dashing figure, though, possessing the high forehead and cheekbones of the aristocratic ApBlanc clan. He walks with a proud bearing and moves with grace. He has long, supple fingers and a deep, melodic voice. His vampyric nature accentuates his physical appeal.

Until he reached his midteens, Tristen lived with the druids and wore the simple brown kilt preferred by those clerics of nature. In the two centuries that followed his murder of Rual, Tristen lived like a wild animal. Trapped in the sacred grove, he wore nothing but bloody rags that once were the clothes of his victims.

After Tristen built and moved into the Lord's Tower in 1809, he dressed in the bright clothes of a minstrel. As he vainly tried to fill his life with the joy that was forever denied him, Tristen hid his evil nature behind the muted, primary colors of his kilt, shirt, and tam. These are the clothes Tristen wears in Castle A.

When Tristen reappeared and began to repair and expand the Lord's Tower into Castle ApBlanc in 1906, he donned the clothes of an aristocrat of that day, wearing the traditional tartan of Clan ApBlanc: a white kilt with green stripes, a sporran decorated with the ApBlanc family crest (a mailed fist gripping a white feather), a dark green shirt with lace cuffs and collar, white knee-high wool socks, and polished black shoes with wide silver buckles. He was still affecting this habit when Forfar entered Ravenloft (in the year 1934) and became the domain of Forlorn. These are the clothes Tristen wears in Castle B.

Since Forlorn's entry into Ravenloft, Tristen's tastes in clothing have changed, reflecting his evil nature. The kilt Tristen now wears is black with a silver-striped tartan. His shirt is of white silk, with puffed sleeves marked with red slashes. He also wears white wool knee socks, low black boots, and a cloak decorated with the same tartan as that of his kilt. These are the clothes Tristen wears in Castle C.

### Telltale Signs of Vampirism

Tristen is not readily identifiable as a vampyre. His eye teeth elongate only when he is on the hunt or ready to kill. They otherwise have a normal shape, except when Tristen is angry or excited, at which time they grow involuntarily.

As a vampyre, Tristen needs to drink blood (12 hit points' worth) only once every four days to sustain himself, but he loses 1 HD per day (beyond the fourth) without that sustenance. On the other three days he eats normal food, but he requires only one meal per day.

Tristen has no aversion to garlic, blessed accoutrements, or holy symbols. He is, however,

## II: THE LORD OF THE LAND

vulnerable to some special items, as described in "Weaknesses," below. Because vampires are not harmed by sunlight, Tristen can venture outside during daylight hours. However, sunlight can leave him with a painful (although not life-threatening) sunburn. For this reason, Tristen prefers to stay indoors when the sun is shining. Fortunately for him, the skies of Forlorn are nearly always overcast.

Tristen's high Charisma score, coupled with his vampyric magnetism, means that PCs will be favorably impressed with him when they meet him in this form. He is *extremely* handsome and personable. While his Charisma score will easily affect nonplayer characters and intelligent creatures, it falls upon the DM to convey this presence to the player characters.

In essence, the DM should use any means at his or her disposal to portray Tristen as a friend, ally, or tragic victim. If there are females in the party, Tristen should be chivalrous, gallant, and romantic in their presence. With men he is respectful, supportive, and willing to feed the hungriest ego. He'll even accept short-term setbacks in his agenda to earn their trust. Any PC action motivated by suspicion should prove fruitless. This is a real role-playing challenge, but there are enough ghosts in the castle to keep the PCs wondering who the lord is, and Tristen's own dual identity allows him to be evil by night and play the good guy by day.

### Weaknesses

**T**risten is a formidable foe, but he does have some weaknesses. Most of them are little more than a nuisance while others pose a grave danger to this unique and powerful lord.

In either form, Tristen is susceptible to damage from holy water, which burns him like acid and leaves *stigmata* (scars) on his vampyre body. (Note that normal vampires are not vulnerable to holy water—Tristen's allergy relates to his personal history.) However, in ghostly form his fourth-magnitude status limits the damage to 1d4 points per hit.

The average holy symbol holds no terror for Tristen, and he can even handle them without sustaining damage! He cannot be turned by them, either in ghostly or vampyric form. The sole exception to this rule is a holy symbol of the Celtic god Belenus. This symbol alone, in the hands of a cleric of good alignment, will keep Tristen at bay or burn him by its touch. These holy symbols are special crystals that "hold a piece of the sun" (see page 47). They are fashioned by the druids of Forlorn, who ironically have no turning abilities. Player characters may learn of the power of Belenus's holy symbols if they discuss Tristen's weaknesses with a druid. (Again, note that normal vampires are not turned by holy symbols of any kind—Tristen's reaction is strictly related to his own background.)

A *blessed* deer antler may be used as an *allergen* against Tristen, provoking a reaction similar to that of a vampire confronted with garlic, and a nonmagical weapon made from a consecrated antler inflicts damage upon Tristen as the weapon type in which it is fashioned.

Since Tristen is essentially mortal when in vampyre form, he can be reduced to 0 hit points. His body may even be completely destroyed by fire or other means. In such an event, he will rise as a ghost and then use his ability to *dominate victims*, stealing the body of one of his prisoners in the dungeons (or even that of a PC!). With time, the physical features of the stolen body mutate until they resemble Tristen's original appearance.

Although ghosts are not affected by spells of a biological nature, Tristen is hurt by *cure* spells cast by priests of the Celtic god Diancecht *only*. These spells affect him as a *cause wounds* spell of the same level.

Tristen's greatest weakness lies in the nature of the curse that turned him into a ghost and which bound him within the confines of the sacred grove. During four days of each year—the two solstices and the two equinoxes—he is utterly helpless. Instead of being active day and



## II: THE LORD OF THE LAND

night, he falls into a comatose state. On these druidic holy days, Tristen reverts to pure mortal form and may be permanently killed, never to rise again. (To determine when one of these holy days will pass, roll 1d100; the result is the approximate number of days until the next equinox or solstice occurs.)

This weakness is Tristen's most closely guarded secret. He will kill any who ferret it out—or even seem close to discovering it. As a further precaution, on those days when he falls into "mortal slumber," Tristen retreats to one of two sanctuaries that are carefully guarded by his minions and protected by deadly traps.

### The Sacred Oak

One of Tristen's most curious vulnerabilities lies in his link with the oak tree at which his mother was hanged and under which he murdered Rual. It is not known what dark power was created by the death of Tristen's two mother figures, but it would appear that the old oak is the anchor that imprisons Tristen within the area of the sacred grove. Tristen cannot move further than 100 feet from the tree, but he refuses to destroy it for a very good reason: The night Tristen set fire to the sacred grove, he felt the flames licking at the old oak—and that was the source of the hideous screaming heard in the forest on the night of the fire. The tree was noted to have survived the blaze virtually untouched, but Tristen's ghost shows signs burn damage instead.

Since then, Tristen has judiciously avoided harming the tree, and he will attack without mercy anyone who hurts it. Indeed, an assault upon the tree should be treated as an attack upon Tristen himself, and all damage is assessed to him. Meanwhile, Tristen suffers a -2 penalty to his attack rolls due to the agony he experiences on behalf of the oak. If such attacks reduce Tristen to 0 hit points, the tree falls. Nevertheless, unless Tristen is permanently destroyed, the tree rises and regenerates right along with him.

Ironically, destroying the sacred oak is a means by which Tristen's curse can be broken. If the PCs chop down the tree on one of the druidic holy days, while Tristen is a mortal, he will no longer be anchored to the castle and can continue his reign of terror anywhere he chooses. (See "A Dire Warning," in the *Eve of Sorrows* adventure.)

### Current Sketch of the Lord

For 513 years, Tristen has been trying to escape the effects of the curse that Rual bestowed upon him with her dying breath. To date, all efforts have been unsuccessful. Burning the holy grove, felling trees, uprooting their trunks, and all other attempts at desecrating the site have all failed.

Possibly, destruction of the old oak might break the curse, but two things hinder that course of action: First, the tree is immune to all forms of magical attack; whether this is a result of druidic magic or Tristen's curse is not known. Second, if the tree is struck with an axe, exposed to fire, or otherwise attacked, Tristen feels its pain, absorbs its damage, and immediately comes to defend the sacred oak.

Still, Tristen is not one to give up, especially when his own freedom is at stake. His efforts to escape the curse continue. His current plans involve a scheme to destroy Rual's ghost (which haunts the site of his castle). He hopes that once her ghost has been laid to rest or destroyed, the curse will end. Tristen has so far been unable to destroy Rual's ghost, and a search for her remains has been equally fruitless. If possible, Tristen might enlist adventurers' aid in these endeavors.

Tristen also believes that he might escape the curse by eradicating the last vestiges of druidic magic from Forlorn, either releasing him outright or allowing him to fell the sacred oak. To this end, he maintains a ruthless persecution of what remains of the druidic following, imprisoning and killing its members. He has ordered his minions to put the few forests that remain in Forlorn to

## II: THE LORD OF THE LAND

the axe and torch in an effort to destroy the last of the sacred groves. His campaign also involves the elimination of all records of the gods once worshiped in the realm, and destroying all symbols and accoutrements of those gods.

To carry out these plans, Tristen relies upon his goblin minions, since he himself is trapped within his castle. Unlike other lords of Ravenloft, he cannot sense what is happening in his domain, except through the thoughts of his goblins. Due to the low intelligence of these minions, his knowledge of the affairs of his domain is sometimes imperfect. And due to the inability of the goblins to carry out complex tasks, Tristen's plans often go awry.

It is perhaps because he is punishing their failures that Tristen tolerates incessant "clan wars" between the goblins of Forlorn. Or perhaps the skirmishes serve as a vile form of entertainment for this most evil lord.

Over the centuries Tristen has become an exceptionally adept liar. If confronted by adventurers, he carefully bends the truth in an effort to

win them over to his side, presenting himself as the aggrieved victim. In ghostly form, Tristen may try to convince adventurers that he is the restless spirit of one of the druids so ruthlessly persecuted in Forlorn. In vampyre form, he will present himself as either a melancholy widower who has lost all those he loves (Castle A), as the rightful chief of a clan who is regrettably forced to uphold his claim to lordship through violent means (Castle B), or as an adventurer who wandered into Tristenoira castle and was trapped there by evil ghosts, including the ghost of Rual (Castle C).

As lord of Forlorn, Tristen is powerful enough to easily deal with any adversaries brave enough to make the trek to the grim castle on the bluffs and confront him on his home ground. Indeed, he need not resort to guile, yet he finds a perverse enjoyment in doing so. Tristen delights in weaving a web of lies around characters, lulling them into a false sense of security and trust—and then springing like a deadly spider from the center of his web.

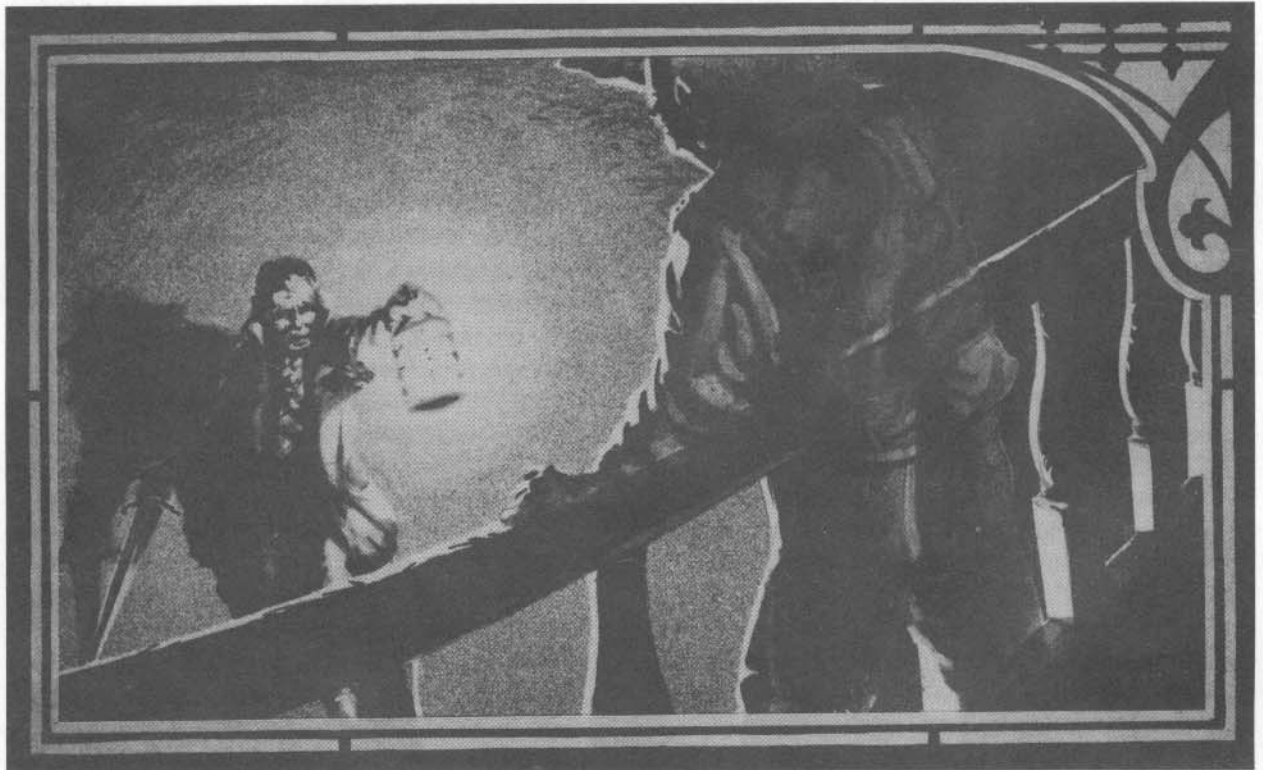



## II: THE LORD OF THE LAND

### Confronting Tristen

**T**risten is confined by his curse to the Castles Forlorn, so PCs won't encounter him anywhere else in the domain. He can monitor the goings on in Forlorn only through his goblins, so it's possible to approach the castle undetected.

If PCs approach by day, they probably won't recognize the man who greets them as a vampire. Indeed, in this form Tristen will attempt to convince player characters that he is a person of good alignment. He may even offer or pretend to aid adventurers in a campaign against his ghostly alter ego. If the adventurers meet him by night, they should have no trouble recognizing the incorporeal Tristen as a ghost.

Because his appearance is so different from day to night, PCs are unlikely to connect the two. The castle is filled with so many ghosts, it may also be difficult for PCs to tell which one, if any, is the lord. To further confuse things, Tristen will attempt to convince adventurers that the ghost of Rual (which also inhabits the castle) is the evil lord of the land.

Adventurers will be better able to sort out the true state of affairs if they spend some time exploring the domain of Forlorn before tackling the castle. This will give them a chance to learn the extent of Tristen's control over his minions, to meet the druids who oppose the lord, and to learn of the strange effects that the druidic holy days have upon the land, thus gaining clues to some of Tristen's weaknesses.

### Closing Forlorn's Borders

**A**lthough it has never been witnessed (or at least reported), Tristen can close the borders of his domain, just like most other lords of Ravenloft. Those whom Tristen wishes to prevent from leaving Forlorn will find themselves utterly unable to move as they touch the border. They will remain in whatever position they are in (that is, standing, sitting on a mount, or hanging in midair if they were flying) until Tristen chooses

to free them. During this time, they are frozen in place as if a wizard had cast an infinite-duration *hold person* spell upon them. Held characters are aware of what is happening around them, but they are powerless to move or speak. Tristen need not concentrate on maintaining the effect, and it is broken only if he is killed.

Fortunately for would-be escapees, Tristen is only aware of those attempting to flee his domain if he can "see" them through his telepathic link with his minions, so a border closure can take place only under the watchful eyes of goblins.

Of course, Tristen may order the fleeing, immobilized character to be killed by his minions. Sometimes, Tristen simply uses a border closure to temporarily detain a troublesome individual until things can be set to right within his domain once more. In these cases, the adventurer is simply immobilized on the border until the minions have made his or her departure meaningless. Individuals held on the border hunger and age just as they would normally. If Tristen's minions take too long to set things right, the poor wretches could die of starvation or (if sustenance is not a problem) wither away from old age.

Companions of the held victim, or passing druids, can attempt to rescue or aid him or her. It is possible to manipulate the body (enabling the individual to be force fed, for example), and the person may be removed from the border and carried to a safe haven. This does *not* negate the magical bonds that hold the person—even if the affected person is carried to another domain!

At the DM's option, some forms of magic can restore mobility before Tristen relinquishes his grip. Spells that can be used to counteract the magical effects of a border closure include *dispel magic* (treat the border closure effect as if it were created by a spellcaster of 18th level), *freedom* (the reverse of the 9th-level wizard spell *imprisonment*), and *wish*. However, Tristen will immediately realize that his hold has been broken and he can reassert control if the character attempts to escape again.

### III: THE LAND FORLORN



*he wind was a torrent of darkness upon the gusty trees,  
The moon was a ghostly galleon  
tossed upon cloudy seas,  
The road was a ribbon of  
moonlight over the purple  
moor. . . .*

—Alfred Noyes

While it was still in the Prime Material Plane, Forfar was a land of rolling hills, lush forests, and sparkling streams. The land's entrance into the Shadow Plane was preceded by months of earth tremors, strange lights in the sky, hot, foul winds, and rumbling noises deep underground. Few would survive what was to come—at least in human form—but those who did recorded this period of Forfar's history (and especially the year 1934) as the "Time of Terrors."

When Forfar was at last wrenched from the Prime Material Plane, the forces of evil reshaped it, twisting and mutating the land to a new topography. Mountains bulged where before there had been rolling hills. Streams changed course and new lakes were formed. Pieces of the land fell away to leave jagged cliffs and sheer precipices. Entire forests of trees fell over as if they had been flattened with the sweep of a giant's hand. The sky clouded over and a cold, bitter rain began to fall.

The transformation was a source of macabre delight to Tristen. Further corruption of the land is something he actively encourages. If he cannot be free to wander his domain, he will see that it is not enjoyed by anyone else.

Today, the domain of Forlorn is a dark and desolate place. Parts of it are still forested, but Tristen's goblin minions are working hard to denude the hillsides. Only a few tiny pockets of true forest remain—the sacred groves, protected by the druids.

The one village that lay within the original land of Forfar—the town of Birnam—lies in ruins

below the cliff on which Tristenoira castle is perched. Scattered across the rest of the landscape are abandoned farmhouses, most of them tumbled by the force of the massive tremors that occurred when the area entered the Shadow Plane.

Overshadowing everything is the mountain peak known as "Arawn's Maw" because the gaping crack at its summit is thought to open into the underworld itself. When it rains (as it usually does in Forlorn) the mountain sends clouds of foul-smelling vapor into the gloomy, dim air.

On the whole, the domain of Forlorn is a cold, brooding place. Only rarely do the dark clouds overhead part to let a glimmer of watery sunlight reach the murky soil. By day, drizzle falls and the forests are dripping and damp. By night, the winds blow. Thunder grumbles ominously in the distance and an occasional flash of sheet lightning illuminates the sky.

Because the domain is uninhabited (save for evil goblins or the occasional renegade druid), there are no warm hearths, no safe resting places. As its name so aptly suggests, Forlorn holds no refuge for the weary traveler. It is a land of farewells, partings, and sorrow.

#### The Blighted Forests

**A**t first glance, the domain of Forlorn appears to be lushly forested. Closer inspection of its forests, however, quickly reveals the bitter truth. Although a number of trees survived Forfar's entrance into the Shadow Plane, they, like the land itself, were transformed by the shift. The trees that now make up the forests of Forlorn are twisted and bent, their leaves spotted with mold, their needles brown with disease. Some are so thick with crawling masses of caterpillars that they seem to be alive. Others are infested with ticks that drop upon any warm-blooded creature passing beneath the branches they infest. Trees with hollow trunks are home to stinging insects and other unpleasant vermin.



### III: THE LAND FORLORN

The devastated forests of Forlorn show none of the fresh green colors of healthy, growing plants. Instead, there are somber browns, grayish greens, and dark shadows. Many of the trees that make up the forest are dead, although they remain upright, adding to the apparent thickness of the forest. Others appear to be solid and whole, but are dry and dead from the midpoint up. These are known as widow makers, due to their tendency to snap in half while being chopped down. The upper portions come crashing down on unsuspecting foresters, killing them and leaving widows and orphans in their wake.

The space beneath the trees is thick with brambles and weeds. Where delicate flowers and medicinal herbs once bloomed, the ground now is covered in scraggly weeds, thorny briar, and poisonous mushrooms. Those fortunate enough to stumble upon a trail will usually find that it leads only to a goblin lair.

The gnarled trunks and twisted branches of the trees of Forlorn have led many to speculate that they might be possessed of some form of sentience. Indeed, by the dim light of an overcast day, when a wind is stirring the branches, the whole forest seems to be alive. There have been wild tales of trees that swallow adventurers whole, and there are even rumors that entire forests of trees have suddenly pulled their roots from the ground and staggered away to leave a barren, desolate hillside behind. Others say these are only the tales of foolish old men.

There are indeed dangers lurking in the forests of Forlorn. Quickwood trees dot the hillsides and have drawn unsuspecting travelers into their gaping maws by means of their grasping roots. Evil treants stalk the land, some of them bending the wills of normal trees to do their foul bidding. Undead treants, appearing at first to be no more than gnarled, rotting stumps, make use of twisted druidic magic to immobilize their victims and then attack with sharpened branches and draw their life's blood from them.

Perhaps most fearsome of all are the death's head trees (see page 94). These evil plants

mark places where a quantity of blood was once spilled. Even more dangerous than the trees themselves are the hideous, rotting fruit they bear and their deadly seeds. Death's head trees grow both within the forests and in isolated clumps throughout Forlorn.

The air in the forests is fetid and damp. Fungi grow on rotting trunks and in the spongy ground. Phycomids and small ascomids, normally found only in subterranean environments, thrive here in the dim light beneath the crowded trees. Dark patches of obliviax (sometimes called "memory moss") can also be found here, as can two varieties of carnivorous plants: choke creepers and the dreaded hangman tree.

Travel through the sickly forests can be an unnerving experience. The wind is always rustling the leaves and stirring the bushes, making the forest seem alive and menacing. Dead and rotting plants are everywhere, underfoot, giving the air an unsavory odor. The overall effect is as if eyes were watching from behind every blasted tree trunk, from under every leaf. And, sadly, that impression is not far from the truth. . . .

#### The 'Cleared Ground'

**T**risten's war against the druids of Forlorn has taken a new twist in recent months. After years of sending his goblin minions into the heart of the forest to search out and capture the druids, he has concluded that the best way to ferret out what remains of the druidic faithful is to utterly remove the forest that protects and sustains them. Arming his goblins with axes, Tristen has sent them out into the forest with orders to cut down every tree, no matter how small.

To date, the goblins have cleared a swath of land on either side of the road leading to Tristenoira castle, as well as a good portion of the hillside on the other side of the castle. They have also been at work on the lower slopes in the southeastern corner of the domain.

### III: THE LAND FORLORN



In these areas, no living vegetation survives. The hillsides are shifting morasses of mud, studded with rotting tree trunks and branches with broken, sharp ends. The air is foul and travel is slow and perilous. Those moving across the cleared ground will often find themselves mired to the knee in thick, sloppy mud. (Movement on these slippery slopes is the same rate as that in a swamp.)

When the project of “ground clearing” began, Tristen had anticipated that the goblins would complete their task in a short time. But the land seems to be conspiring against Tristen. The evil and undead treants, carnivorous plants, and other deadly creatures that inhabit the tormented forest are slowing down the goblins’ clearing efforts more than a little. The progress to date of his minions has not pleased the lord, and he often vents his wrath upon them.

#### The Sacred Groves

**H**idden within the infested forests of Forlorn are tiny pockets of green and growing woodland. In these secluded groves, the dangerous vegetation found in the woods gives way to normal, healthy plants. Trees grow tall and free of disease, the underbrush is lighter, the moss underfoot is soft and fragrant, and tiny white flowers bloom. There is even the occasional sprig of mistletoe and the chance medicinal herb. Here are found the trees worshiped by druids: the oaks and rowans.

These sacred groves—revered by those who follow the druidic faith and used as a base for their ceremonies, rituals, and meditations—are all that remain of the bountiful forests that once covered the entire land of Forfar. Two of these forested groves are very small, less than a mile in diameter. The other two are only slightly larger, perhaps one and one-half miles across.

In the days before Tristen corrupted the land, Forfar was a place of balance and harmony. Clan wars might rage, neighboring countries might rise and fall, but the land itself remained



## III: THE LAND FORLORN

unchanged, carefully tended by the druids as the wheel of the seasons turned.

When Forfar entered Ravenloft, all of that changed. The forces that reshaped it destroyed much of the forest in a single cataclysmic night. Blight and disease swept quickly over much of what remained. Still, enough healthy forest endured to serve as a shelter and haven for those druids whose faith had enabled them to cling to their human form. For a number of years they were able to preserve what remained of the forest. Working secretly, they even reclaimed some areas that had been struck by blight, but those early successes drew the attention of the lord of the domain.

Tristen's campaign to eliminate the druidic contingent from the domain of Forlorn began in the Forfar year 2009. As druids were imprisoned and executed over the next century, their influence upon the land waned. Today, only tiny pockets of the original forest remain. The rest has been razed or corrupted by Tristen and his goblin minions, to better fit with the lord's dark designs.

However, even in Ravenloft the land is fighting Tristen, working to restore its own natural balance. On four days of the year (the two solstices and two equinoxes), new oak and rowan seedlings sprout as the land makes a feeble effort to recover. These tiny trees grow to a height of one foot on the first day that they sprout, but thereafter they grow at a normal rate. They are carefully gathered by druids at points throughout the domain and then planted in areas where the faithful can watch over them. With time and adequate protection, it is hoped, these tiny patches of green may form new sacred groves. It is interesting to note that oak acorns and rowan seeds sprout only on the druidic holy days, regardless of when they are planted, but they will grow virtually anywhere, even on barren rock or within the castle itself.

After experiencing the terrors of the afflicted forest, these groves might lead travelers to heave a sigh of relief and let down their guard, but this is a dangerous thing to do. While the

flora itself is not hostile, the groves are no protection against the evil creatures of Forlorn, which can pass through the trees at will. What remains of the druidic faith is determined to hold evil at bay in the sacred groves, but more often than not the druids fall prey to the forces of evil that hunt there.

### The Lake of Red Tears

**T**his lake lies in a narrow, twisting valley that was formed when Forfar was violently reshaped to create the domain of Forlorn. At that time, a series of landslides formed the lake, merging several smaller pools into one. At its northern end, the Musarde river runs into Gundarak.

Around the fringes of the lake, black, barren fir trees reach up from the water like skeletal hands. Once they stood proudly on the mountainside. Now they are grim reminders of the death and decay that haunt this land.

Rearing up on either side of the lake are 1,000-foot-high red granite cliffs. By day, the surface of the lake appears almost black—what little sunlight penetrates Forlorn's customarily overcast skies is further screened by the cliffs, which throw the lake into deep shadow. From time to time, at sunset, the blood-red rays of the sun emerge from under the veil of clouds. Reflecting off the red granite cliffs, they give the lake's surface a ruddy hue. This coloration might be the simplest and most logical explanation of how the Lake of Red Tears got its name, but the renegade druids of Forlorn have maintained an oral history that offers other, perhaps more probable, stories.

One legend holds that a smaller lake on this same site was known by the same name in pre-Ravenloft days. A bardic song (now known only to the druids of Forlorn) tells the story of a vampire who came to the shores of the lake to mourn the loss of his mortality. A girl from the town of Birnam saw him crying bloody tears; hence the pond got its name. (The song, known as the "Lament of the Dead," is loosely based on

### III: THE LAND FORLORN

the life of Rivalin, Tristen's father. As a vampyre, Tristen—if he cries at all—cries normal human tears.)

Another tale claims that on the “turning points” of the year (the equinoxes and solstices), the granite cliffs weep blood into the lake. This phenomenon, some say, is a result of the land's sorrow for what it has become.

Yet another legend has it that druids captured by the goblins are taken to the shores of this lake, where they are fed to a fearsome monster that inhabits its depths. “The lost gods,” it is said, “weep for the druids who once served them.” It is their tears that stain the lake red.

#### **‘Aggie’**

There is a grain of truth to the lake monster legend. The Lake of Red Tears does indeed contain a monster. Known as Agatha, or “Aggie,” the creature is generally thought to be some sort of serpent. Travelers to this part of Forlorn have reported a series of humped shapes breaking the surface of the dark lake. Some say the humps are all part of a single monster while others claim there are a number of monsters inhabiting the lake. As yet, no one has secured a detailed description of the beast, but some sages theorize it is a giant sea snake of some kind, trapped inside the lake.

In fact, Aggie is a monster unique to Ravenloft and specifically to the domain of Forlorn (see page 93). An undead form of sea serpent with a breath weapon as powerful as that of any dragon, she exists only in the Lake of Red Tears. None know how the monster got into the lake, but judging from Aggie's apparent size and the lake's distance from any sizable body of water, it is likely that she was put there by some powerful being. Certainly none of the area ponds were deep enough to hold such a creature before the formation of the Lake of Red Tears in 1934. There is speculation that the lake might be bottomless, that the water which flows from it to join the Musarde River bubbles up from some distant spot on another world.

Perhaps the lake is a portal to another plane and even offers an escape from Ravenloft. Or perhaps the lake does have a bottom—one lined with a multitude of treasure that fell from the bodies of Aggie's victims. To date, none of the adventurers who have visited Forlorn have been brave enough to put either theory to the test.

The lake also holds more mundane dangers. For example, the water is infested with throat leeches and thus is not safe for drinking. These creatures live only in the lake itself; a short distance down the river, the water flows rapidly and is clear. The lake is also home to a number of electric eels.

#### **The Maw of Arawn**

**W**hen Forfar entered Ravenloft, the forces that shaped it acted with such force upon the land as to rend it to the core, creating a malevolent rip in the surface of the domain. This gaping fissure, located at the top of the domain's highest peak (4,500 feet high), was initially called the “mouth of the underworld.” In time, it was renamed for the Celtic god of death and the underworld: the Maw of Arawn.

The fissure is perhaps 500 feet wide and half a mile long, running in a jagged line along the rocky crest of the peak. Since there are no trees on this part of the mountain, the vapors that pour out of the crack are easily seen. Yellowish, these billowing vapors are thought to contribute to much of the cloud cover that perpetually enshrouds the domain.

No traveler in recent memory has had the audacity to scale the mountain and approach the Maw of Arawn. Most who have seen it from afar hold that its vapors must be injurious at best, and they are more likely to be lethal. Since no one has ever looked into this steaming breach, it is impossible to say what lies inside. Perhaps it is indeed an entrance to the underworld and the realm of the dead. It might be filled with bubbling mud or molten lava. Or perhaps something wondrous lies inside. . . .



### III: THE LAND FORLORN



#### The Caverns of the Dead

**N**ear the Maw of Arawn, a short way down the east face of the peak, a cave mouth can be seen in the side of the mountain.

Although it is clearly visible from the hillsides below, only the very brave or very foolish venture up to peer inside, for the caverns that lay beyond the entrance serve as a catacomb for goblin dead.

The Caverns of the Dead were carved in the mountain centuries ago by a river of lava, and they were one of the few geological features to survive the area's transformation into a Ravenloft domain. They include a number of interconnected, mazelike tunnels and caverns, thick with stalactites and stalagmites. Underground streams fill the caverns with ominous murmurs while a steady dripping throughout the complex gives the air a cold, damp feel. Strange shapes of the stone, seen by

flickering torchlight, make the caverns appear to be filled with oddly contorted creatures, and the squeak and rustle of bats overhead add to a feeling of tension. The air itself seems thick.

In the innermost chambers of the Caverns of the Dead, goblins lay out the corpses of their fellows. The precise form this burial takes and what strange and evil rituals are performed here, none can say. Equally unknown is the reason why the goblins of Forlorn have chosen this spot to lay their dead. Perhaps they feel the caverns' proximity to the fissure (which is sacred to Arawn, god of the dead) will protect the bodies of their fellows from being raised as undead creatures. (Arawn, after all, is a jealous god who rarely releases the bodies or souls of those he has claimed as his own.) Or, perhaps, the caverns hold some long-buried memory for the goblins, who once were men and women.

## III: THE LAND FORLORN

### Sanctuary

**T**his series of caves provides a place of refuge for the druids who oppose Tristen, and it is known simply as Sanctuary. There are five of these complexes scattered across Forlorn. The entrances are carefully concealed, and the druids use their woodland skills to avoid leaving a trail that would lead the lord's minions to their sanctuary. Throughout 113 years of Tristen's oppression, the location of Sanctuary has remained a secret. No captured druid, no matter how heinous the torture, has revealed the location of the caves, but it's doubtful that this state of affairs can go on forever.

Sanctuary serves as a temporary refuge for druids who have been injured or whose faces are known to Tristen's minions. It is a stopping place for the weary, a place to rest and regroup rather than a permanent home. The druids of Forlorn, like all who worship nature, prefer to spend their time outdoors among the forests and woodland creatures they have sworn to protect, despite the inherent danger.

The caves that make up Sanctuary are small; none are more than a few yards wide, but over the years the druids have linked several of the caves with a series of tunnels. There have been some in the order who argued that time spent worming through the underdark would be better spent praying in the forest and protecting what remains of the sacred groves, but when goblins attack and the time comes to disappear into the hills, these grumblings always disappear.

Some of the caves that comprise Sanctuary are stocked with medicinal herbs and bandages, and they serve for makeshift places of healing. Others contain foodstuffs or secret caches of holy accoutrements. Still others are fitted as comfortable resting places, where druids can disappear from sight for months at a time. Whatever its purpose, the location of each and every cave is a closely guarded secret. Only a handful of the highest-level druids know the location of all of the caves and all of the secret entrances and exits.

The druids will generally refuse to take any but a member of their own druidic order into Sanctuary. Only in the most extreme emergencies will they take outsiders to one of the caves—and then only if steps are taken to ensure that the outsiders have no knowledge of the cave's precise location.

### The Ruins of Birnam

**A**pproximately one mile from the shores of the Lake of Red Tears lies all that remains of the once-prosperous village of Birnam, first ruled by the ApBlancs and then the ApFittles before it was destroyed in the cataclysm that transported the land to the Shadow Plane. In those days the village was home to perhaps 1,200 people. Its largest building was ApBlanc Hall, a medium-sized keep that was inherited by the ApFittles when they became the ruling family of Clan ApBlanc in Forfar year 1637.

Around the keep were scattered the homes of the commoners—buildings made of slabs of stone mortared in place like bricks and topped with thatched roofs. The shops and inns were built in the same fashion, except that they had more durable plank-and-tile roofs. The town halls and churches were more elaborate still, with clan crests or gods' holy symbols carved in the wooden beams of their walls.

ApFittle Hall was completely gutted by fire in Forfar year 1930, when Tristen's mercenaries triumphed over the soldiers of the ApFittles. Today, only a hollow shell remains.

The rest of Birnam's houses, shops, churches, inns, and halls were inhabited and in use until Forfar year 1934, when Forfar entered Ravenloft as the domain of Forlorn. In that "year without a spring," crops refused to sprout, the earth trembled and groaned, and strange lights filled the sky. Most of the population of Birnam fled during what came to be known as the "Time of Terrors," and so did many of the farmers who had small holdings scattered throughout Forfar.

When at last the land was wrenched into the demiplane of dread, those few humans who



### III: THE LAND FORLORN

remained were transformed into goblins. Abandoning their homes, the newly formed goblins fled to the woods, taking up an existence not far removed from that of wild beasts. The town of Birnam fell into ruin, as did the farmhouses that once dotted the land. Thatched roofs and wooden floors rotted away, and stone walls crumbled in the violent earth tremors that reshaped the landscape. Few of the remaining buildings have more than one or two intact walls.

Apparently some distant, ancestral memory continues to draw the goblins back to Birnam. They sometimes stand outside the ruined homes, staring intently at the scattered masonry with their glowing red eyes as if trying to unlock the secret of their origin. Like the demolished town, the goblins are grim reminders of the sad fate that befell this once thriving land.

#### The Road to the Castle

The approach to Castle Tristenoiria lies along a narrow road that was carved through the forest in the 2030s by loggers from the neighboring domain of Gundarak. Because taxes are high in that domain, and even firewood cannot be gathered without a levied charge, the folk of Gundarak thought the forests of neighboring Forlorn offered a means of escape from their debts. Even the terrors of Forlorn's monster-plagued forests did not hold them in check. Amazingly enough, Duke Gundar allowed the logging to continue, for he could always tax sales of the wood harvested in Forlorn once it was sold in his domain.

Throughout the 2040s, the loggers continued to expand the road along the crest of the hill whose northern tip extended into their domain. Gradually, they pushed around a wide bend, following the thickest patches of trees. In time, they found a trail and followed it. That trail, made by goblins, led to Castle Tristenoiria.

During all this time, Lord Tristen ApBlanc of Forlorn had been aware of the activity of the mortals who had crossed his northwestern

border, but he allowed their transgressions to continue for two reasons. First, logging the forest often flushed out druids, and second, the fresh influx of mortals gave Tristen new victims to feed upon in vampire form.

When the loggers discovered the goblin trail and approached the very gates of Tristen's castle, however, it was time to act. Rallying his goblin minions, Tristen had them spring upon the loggers, who fled in terror from the savage, seemingly unprovoked attack.

Today, only an occasional group of loggers from Gundarak dares to venture over Forlorn's border, and then only briefly, but the road that was constructed nearly one century ago remains. Built of half-logs placed side by side, forming a crude path through the forest, the roadway is overgrown, but it provides a dry path through the devastation wrought by the goblins who have cleared ground in accordance with Tristen's orders. In the morass of mud left behind, it provides some of the only solid footing in the domain.



## IV: DENIZENS OF FORLORN



*ackwards up the mossy glen  
Turned and trooped the goblin  
men. . . .*

*One had a cat's face,  
One whisked a tail,  
One tramped at a rat's pace,  
One crawled like a snail.*

—Christina Rossetti

Forlorn is a realm devoid of civilization. No city or village survived the cataclysm that drew the land into the Shadow Plane. Nor has any human or demihuman come to claim this domain as home, with the possible exception of the druids,

but they see themselves as expatriates in a hostile country. Nevertheless, Forlorn is far from unoccupied. This chapter describes the monstrous inhabitants of Ravenloft's second domain, beginning with its most numerous residents, all of whom serve Lord Tristen ApBlanc most faithfully.

### The Goblins

**W**hen Forfar became the domain of Forlorn, those humans who had not already fled the land underwent a hideous transformation. Their spines twisted as the people shrank in size, their heads became bloated, their ears elongated into points, and their eyes took on a blood-red glow. The hair on the top of their heads fell out and the hair that grew on the back of their heads and necks became greasy and matted. Their mouths widened and their human teeth fell out, replaced by needle-sharp fangs. Likewise, their fingernails fell out, replaced by yellow, hooked claws. Few vestiges of their former human selves remained.

The goblins of Forlorn are intensely loyal to Tristen, whom they refer to as "Master." They don't know his true name, but they wouldn't reveal it even if they did. Fear is unknown to them, and pain is no incentive to cooperate. If

tortured for information, a goblin would die laughing, using its final ounce of strength to spit in the questioner's face. In combat they are similarly fearless. They will never break off a fight unless Tristen orders them to do so.

Tristen communicates with his minions through a telepathic link that is unimpeded by distance or any kind of physical barrier (for example, walls, earth, etc.). Tristen can neither see through the goblins' eyes nor hear through their ears, but he is privy to all of their thoughts. Thus, he is aware of anything that captures their interest, and he can give them general advice on courses of action if he so desires. He is able to form a fairly good mental picture, albeit not absolutely accurate, of anything the goblins observe (and thus think about). He can do this both day and night, since goblins have infravision.

The goblins of Forlorn are put to a number of tasks by Tristen. They act as servants in his castle; they patrol his lands in a constant search for intruders and they bring him human or demihuman captives whose blood he can drink when in vampyre form. (Tristen abhors the taste of goblin blood and thus does not feed upon his own minions.)

The goblins also act as evil foresters, setting out with axe, saw, and torch in a campaign to completely eliminate the forests of Forlorn. They often can be found in the woods, hacking indiscriminately at trees and foliage of every size and description, setting large bonfires, and leaving a wide band of destruction in their wake. To the goblins (and to the master they serve), this muddy swath of splintered, blackened trees is known as the "cleared ground," and it is a thing of beauty.

Fortunately, the forest-clearing projects have not eradicated all the sacred groves of the druids. Since Tristen's orders to raze the forest are general, and because his minions lack basic deductive logic techniques, the goblins tend to avoid areas where "accidents" occur at an alarming rate (thanks to the druids). But should they stumble onto a sacred grove, it is certain the goblins will destroy it with glee.



## IV: DENIZENS OF FORLORN

Tristen also orders the goblins to carry out extensive weeding projects after each equinox and solstice. On these druidic holy days, oak and rowan seedlings sprout across the domain. In the weeks that follow, the goblins go into frantic action, pulling the newly sprouted saplings from the ground and burning them.

Another chief task of the goblins involves the hunting, capture, and imprisonment of any who follow the druidic faith. Since the druids were the only humans to escape the transformation into goblins, *all* humans and demihumans are considered druids by the goblins, including wanderers who stumble into Forlorn. The goblins are under strict orders to bring captives, alive, to Tristen for interrogation. Unfortunately, they are more adept at killing than capture, and they frequently slay their prisoners in a fit of murderous enthusiasm.

Goblins travel primarily on foot, but they also use worgs for transportation. They ride these huge wolves bareback, without bridle or harness, clinging to the worgs' shaggy pelts. Worgs are also used by goblins to hunt druids and other undesirables. Those druids who are thought by Tristen to have no useful information are run down and killed by worgs, rather than captured by goblins.

### Combat

When first confronted, these monsters leer horribly at their foes, exposing all of their needle-sharp teeth and prompting a fear check. If barehanded, goblins fight with their claws, always seeking to get both hands around their opponents' necks (1d6 points of damage/claw). If they successfully hit with both claws, they gain a choke hold upon the victim (1d4 points of suffocation damage/round) and begin a process known as "feasting," where they bite into the victim's face and head (2d6 points of damage/round).

All the while, the goblins are seeking to expose and eat the brains of their victims—a dietary habit they may have acquired from their illithid neighbors in Bluetspur, to the south. The

brain is a delicacy to these carnivores, and it is known as "head lettuce," or "heddice" for short. In the language of the people of neighboring domains, this word has been corrupted, and it is often and mistakenly called "haggis."

While goblins of other lands prefer to fight weaponless, the goblins of Forlorn often fight with normal human weapons, including heavy wooden clubs, finely balanced daggers, and well-crafted broad and long swords. Some wear scraps of human armor or carry shields. The occasional goblin wields a magical weapon (10% chance per group encountered). All of these treasures are remnants of the goblin's human past and are venerated as family heirlooms. Goblins of Forlorn also like to acquire and hoard treasure. Individuals will carry treasure types M and O, while lair (clan) treasures will be type D.

### Habitat/Society

In Forfar and the highlands around it, people were rigidly divided along clan lines. Within Forfar several families peacefully coexisted under the banner of Clan ApBlanc, but when they were transformed into goblins, the various families factionalized and declared themselves independent. This may have occurred as the goblins strove to retain some semblance of their former social structure, but it served to perpetuate the ancient friction that often arose between rival clans. One of the greatest honors that a clan might achieve was the distinction of producing the ablest warriors, and the severing of Clan ApBlanc provided the opportunity to continue that bloody tradition. Where there once was only the Clan ApBlanc, there are now the Clans ApCrae, ApDuguid, ApKie, ApLorran, ApPhale, ApTaven, ApVay, and ApYorrik, as well as a number of minor clans that are little more than gangs of renegades and misfits.

Displaying an odd regressive trait, Forlorn's goblins wear kilts—thick woolen garments woven with distinctive tartans. These garments are cherished by the otherwise indifferent

# IV: DENIZENS OF FORLORN

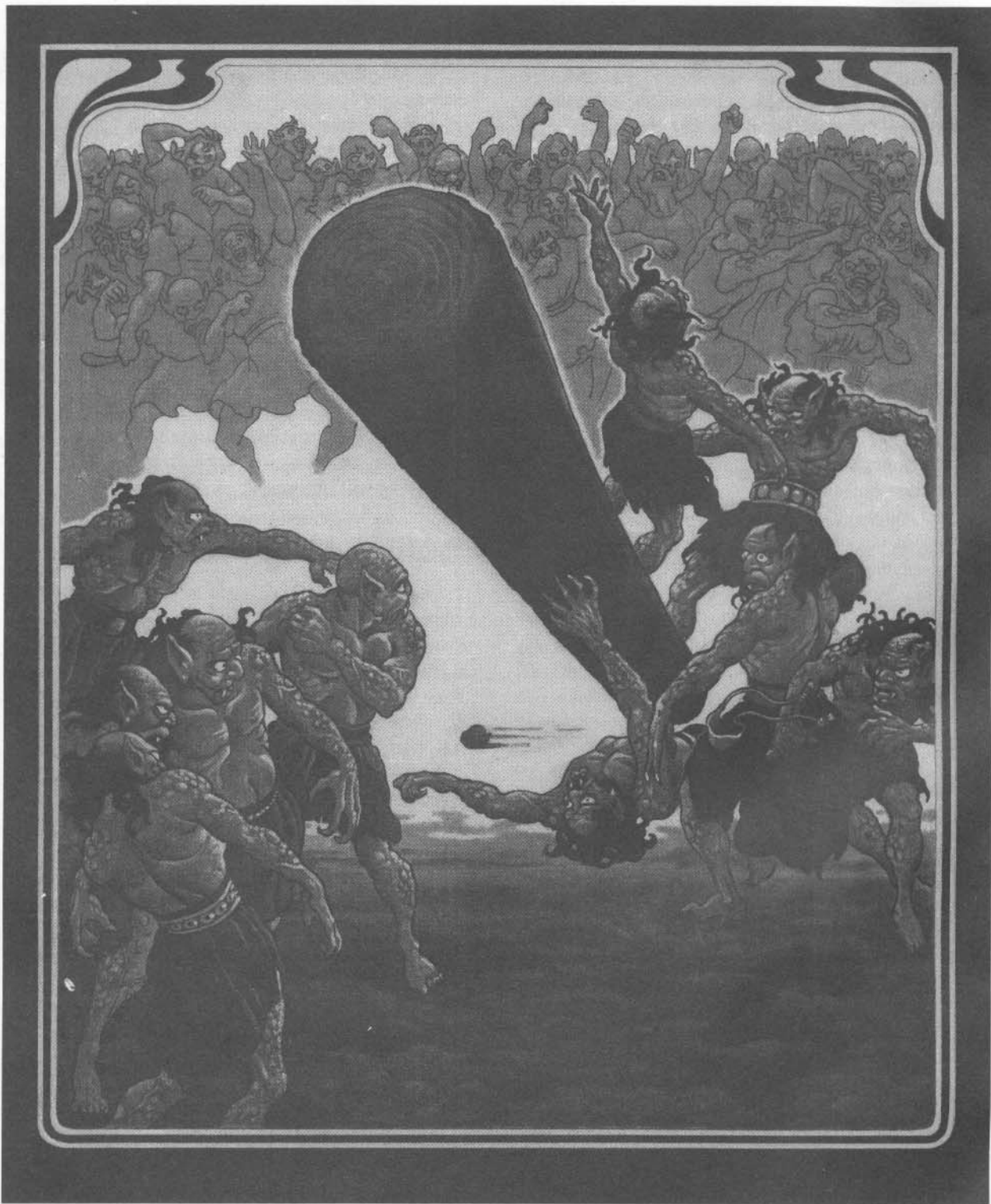



## IV: DENIZENS OF FORLORN

monsters (although they still tend to be old, dirty, and tattered), perhaps because they provide a clearly recognizable distinction between factions. Each clan has a different tartan, and a goblin can tell which clan another goblin belongs to at some distance, just by observing the color and pattern of its kilt. This fashion is a curiosity to the people of neighboring domains, who have come to refer to the goblins as “snag-toothed hags.”

In Forlorn, the goblins have no fixed settlements (having no need of sleep or a place to cultivate food resources), but they tend to remain in the area of their former family holdings, often lurking in the ruined buildings that once were their homes. Sometimes, goblin clan wars erupt over these relatively meaningless territorial claims. Tristen actually encourages these battles, either as a means of alleviating boredom or as a way to punish one clan or another.

### Games

A number of other customs of the highlander clans were retained by the goblins as well. These traditions are most visible at the large clan gatherings that the goblins hold from time to time. At these assemblies, the goblins participate in games designed to test their strength and stamina.

One of the favorite goblin pastimes is known as “arbor-hefting.” In this game, two teams of five goblins stand a few feet apart and toss an incredibly heavy log (15 to 20 feet in length and weighing several hundred pounds) back and forth. The object of the game is to flip the log into the air so that it lands on the heads of the other goblin team members, crushing and killing as many opponents as possible.

Another goblin festivity is known as the sword dance. In this ritual, goblins armed with daggers and swords, called “instructors,” lie belly-down on the ground, facing each other in two long rows with a long corridor in between, called the “gauntlet.” Particularly intrepid goblins, called “dancers,” must “waltz the gauntlet,”

during which time the instructors attempt to slice them to ribbons. The more nimble the dancer, the less grievous the wounds received. A key rule dictates that instructors may not aim higher than the knees unless the dancer falls, in which case there is a bloody free-for-all.

Goblins who do not immediately kill captured adventurers have been known to force them to waltz the gauntlet. This serves as a means of “proving the superiority” of the goblin race, for few people are agile enough to survive it. PCs forced to participate in a sword dance must make a Dexterity check for every two goblins in the line; a failed roll means the dancer suffers 2d6 points of damage. If the dancer should attempt to leave the gauntlet in mid-dance, the goblins will leap to their feet and attack.

Accompanying this dance is a strange and haunting music played on an instrument known as the “dronepipes.” Made from the bladder of a large animal and hollowed-out bones (often human), these instruments produce a mournful wail that can be heard for some distance. Some sages believe that a few of these instruments are capable of producing vile magical effects similar to those manifested by *pipes of haunting* or *pipes of pain*. But while magical properties of the bagpipes are in dispute, all agree that any who hear the wailing of these instruments should expect a goblin attack—goblins also love to play them when they are launching a “surprise attack.” (Nongoblins who attempt to play dronepipes must roll a successful musical-instrument nonweapon proficiency check with a -3 penalty, but they cannot make them function as the aforementioned magical items.)

### Religion

Although there are no clerics among the goblins of Forlorn, these twisted creatures do worship a god: Arawn, Celtic god of the dead. Of all of the pantheons worshiped by these creatures when they were still in human form, only this one god is remembered. Perhaps it is because of Arawn’s great potential for evil, or perhaps it is his asso-

## IV: DENIZENS OF FORLORN

ciation with death and dying things. The religious beliefs of the goblins are straightforward and rather simplistic. Killing things, they say, honors Arawn, for it provides him with more dead to rule over. The greatest glory a goblin can know is death—preferably one violent enough to draw Arawn's attention. Resurrection and reincarnation are evil practices, for they rob Arawn of his subjects. The goblins believe Arawn lives inside the mountain fissure known as the Maw of Arawn, and they use the nearby Caves of the Dead for burial.

### Politics

One more human tradition that the goblins have maintained is the selection of a chief for each of their various clans. These goblins are the strongest and best fighters—and the most vicious and cruel-hearted. But the goblins do not select a baron from among these chiefs, as they did in ages past. Instead, the goblins acknowledge Tristen as their lord.

### Ecology

Very few people in other domains of Ravenloft realize that these twisted creatures were once human. That knowledge can be gained only by speaking with the druids of Forlorn, and they are notoriously reticent and mistrustful of strangers. Thus, as far as the average adventurer knows, there have always been goblins in Forlorn.

Initially (in the year Forfaar 1934), there were about 400 goblins in Forlorn. Some sages theorize that these are the only goblins that have ever existed in the domain, and that the number has dropped considerably in the intervening years, as both adventurers and wild creatures of the land have taken their toll. Those sages point to the fact that goblins neither tire nor sleep, and they can live a considerable amount of time without food or drink. Goblins, these sages say, are virtually immortal, and it is conceivable that the same goblins that appeared in Ravenloft with the domain of Forlorn are here still.

Others who make a study of arcane lore say that goblins are capable of reproducing their own kind, although these sages are at a loss to differentiate male from female goblins. Those who subscribe to this belief say that the number of goblins in the domain has been increasing steadily as they bear more young with each passing year. Whatever the current number, there is no shortage of goblins in the domain.

In either case, it's true that goblins never sleep. They are therefore in constant telepathic contact with Tristen, except on days during which the two equinoxes and two solstices occur each year. From midnight to midnight of those dates, when Tristen falls into a deep sleep, the goblins lose touch with their master and wander aimlessly. They fight if attacked, but with a -2 penalty to attack rolls.

Tristen's goblin minions have only low intelligence, but they are able to speak. Their language is a corruption of the common tongue, but it can be understood by adventurers who listen closely to it.

### Herrd of Clan ApKie

#### Goblin Clan Chief, Chaotic Evil

Armor Class	4	Str	16
Movement	12	Dex	14
Hit Dice	6+4	Con	16
Hit Points	33	Int	8
THACO	15	Wis	7
No. of Attacks	1	Cha	8 (18)
Damage/Attack	1d6+1, 2d6+2, or by weapon		
Special Attacks	special		
Special Defense	nil		
Magic Resistance	10%		
Size	M (6' tall)		
Morale	20		
XP Value	1,100		

Herrd is chief of the approximately 120 goblins of Clan ApKie, the largest of the goblin clans. The heavily muscled leader is more intelligent than the average goblin, and he makes good



## IV: DENIZENS OF FORLORN

use of his superior verbal and mental skills. Although humans will find Herrd rude and obnoxious, members of his own race hold him in great esteem (his Charisma score, when dealing with other goblins, is 18).

Herrd dresses in a kilt with the traditional clan ApKie tartan, checked in wide bands of red and black. He is bare-chested and bare-footed, but he wears a heavy gold chain around his neck and straps a dagger to one ankle. He also wears a flat, circular sporran, made of leather and trimmed with red human hair, which hangs against the front of his kilt.

Inside the sporran is Herrd's most treasured possession: a stained and tattered piece of vellum that is a deed granting the ApKies ownership of a large land holding in Forfar. Badly creased and nearly illegible, it is dated 1656 and bears the signature of Lady Briony ApFittle. Herrd cannot read the document, but he holds it in great reverence.

**Background:** Herrd is one of the original goblins of Forlorn. He began his life as a human warrior in the original Forfar. He has no memory, however, of his previous life and enjoys his existence as a goblin.

**Current Sketch:** Herrd is preparing to challenge Tristen's as-yet undisputed rule over the goblin clans and set himself up as the Baron of Forlorn. He yearns for a day when goblins will pursue their own destiny—under his direction, of course.

Herrd is the only goblin in the domain of Forlorn who is outside Tristen's direct telepathic control. This is due to a family heirloom he always carries with him, a *ring of mind-shielding*. This ring, which Herrd wears on his right thumb, is made of silver and has a shield-shaped emblem that bears the design of a thistle. The ring is so caked with dirt and tarnished, however, that it appears to be made of cheap metal.

Clan ApKie is currently the largest and strongest of the clans of Forlorn. While Tristen maintains his telepathic control over the goblins in the clan, Herrd wields enormous influence



## IV: DENIZENS OF FORLORN

over them as well. They are quick to follow his commands, but if these instructions directly contradict the mental orders of Tristen, the goblins will likely be thrown into great confusion.

Herrd knows that the lord of Castle Tristenoira would beat him on the lord's own ground, so he never journeys to the castle, preferring instead to wield what power he can elsewhere in the domain. Should powerful adventurers offer him a chance to topple Tristen once and for all, it is possible that Herrd might aid them, but not overtly and certainly not in the presence of any goblins who might report back to Tristen! Instead, he will offer advice and information in exchange for a promise that they support his claim as the future clan chief and baron of the goblins.

So far Herrd's plans to dominate the goblin clans have not prompted much of a reaction from Tristen. Indeed, the lord of the domain finds Herrd and his simple-minded schemes much more amusing than the blind obedience of his other goblin minions. If Herrd were to seriously threaten Tristen in any way, then retribution would be swift and merciless.

**Combat:** Herrd has the usual goblin abilities of moving silently and hiding in shadows, as well as the ability to surprise opponents. Due to superior strength, he inflicts 1d6+1 points of damage per hand damage when attacking barehanded.

Herrd prefers, however, to fight with weapons. His weapon of choice is his *sword of wounding*, but he also carries a throwing dagger strapped to his ankle. Herrd's magical long sword (carried in a scabbard strapped to his back) features a pommel in the shape of a screaming human face.

### Things That Go 'Bump' in the Mists

**F**orlorn is all but devoid of inhabitants, but that doesn't mean that adventurers here will have an easy time of it. Day or night, there is

approximately a 30% chance for an encounter. (Roll four times for each 24-hour period if desired. As always, Dungeon Masters running a campaign in the RAVENLOFT® world are discouraged from employing random encounters; all creatures should be chosen and presented to the adventuring party at the DM's discretion!)

By far the most common creatures met will be goblins. Armed with crude spears and daggers, they are under standing orders to capture or kill any newcomers found in the domain and bring them directly to Castle Tristenoira. Note that as soon as adventurers encounter the goblins, their presence is instantly known to Tristen, due to his telepathic link with his goblin minions.

Most ordinary woodland creatures of Forlorn have disappeared or died off, but the land somehow remained populated with wolves. Snarling packs roam Forlorn virtually unchallenged, and they are the most likely type of animal to be encountered.

There are also a number of worgs, intelligent animals that have a rudimentary language. Tristen's goblin minions make great use of these pony-sized wolves, using them as fleet-footed mounts.

Monsters occasionally encountered in the domain of Forlorn include gremishkas (formerly the cats and dogs of Forfar, metamorphosed into this new form) and zombie wolves (see page 96). The latter have no minds and so, while they serve Tristen's purposes (and are at times controlled by him), they have no telepathic link with the lord.

Even rarer monsters found in Forlorn include the warped humanoids known as broken ones (possibly escaped from Bluetspur, in which case they possess psionic wild talents), as well as geists, ghosts, haunts, odems, and the occasional wererat lycanthrope.

A party of wandering adventurers in Forlorn has an outside chance of encountering a few mundane creatures. As a rule, these creatures



## IV: DENIZENS OF FORLORN

stay within the sacred groves, where they may rely upon the protection of the druids.

Encounters with Forlorn's druids are *much* more rare (at the Dungeon Master's discretion only) than most. These religious followers of nature are most likely to be found in and near the sacred groves or in the vicinity of the caves known as Sanctuary (see page 30), although they are sometimes found in the withered sections of the forest, too. If encountered, these druids will flee from adventurers. They prefer to use their own methods to restore balance to the land, and they are unlikely to accept help from outsiders or offer any aid to them. (See Chapter V for complete details on the druids).

**Table 1: Animal Encounters**

Rare	Very Rare
Ants	Broken ones
Bear, brown	Druid, wandering
Beetle, boring	Geist
Goblin	Ghost
Gremishka	Haunt
Hornet (and wasps)	Odem
Owl, common	Wererat
Rats (common/giant)	Worg
Snake, poisonous	Zombie wolf
Spider, large	
Stag (mammal, minimal)	
Weasel	
Wolf	

Those traveling through the unhappy forests of Forlorn face additional dangers from the vegetation, which is itself alive and has a malevolent and voracious hunger. Day or night, the DM can include an encounter with any of the monsters listed below.

**Table 2: Vegetation Encounters**

Common	Rare
Choke creeper	Ascomid (fungus)
Hangman tree	Death's head tree
Quickwood tree	Oblivix
Treant, evil	Phycomid
Undead treant	

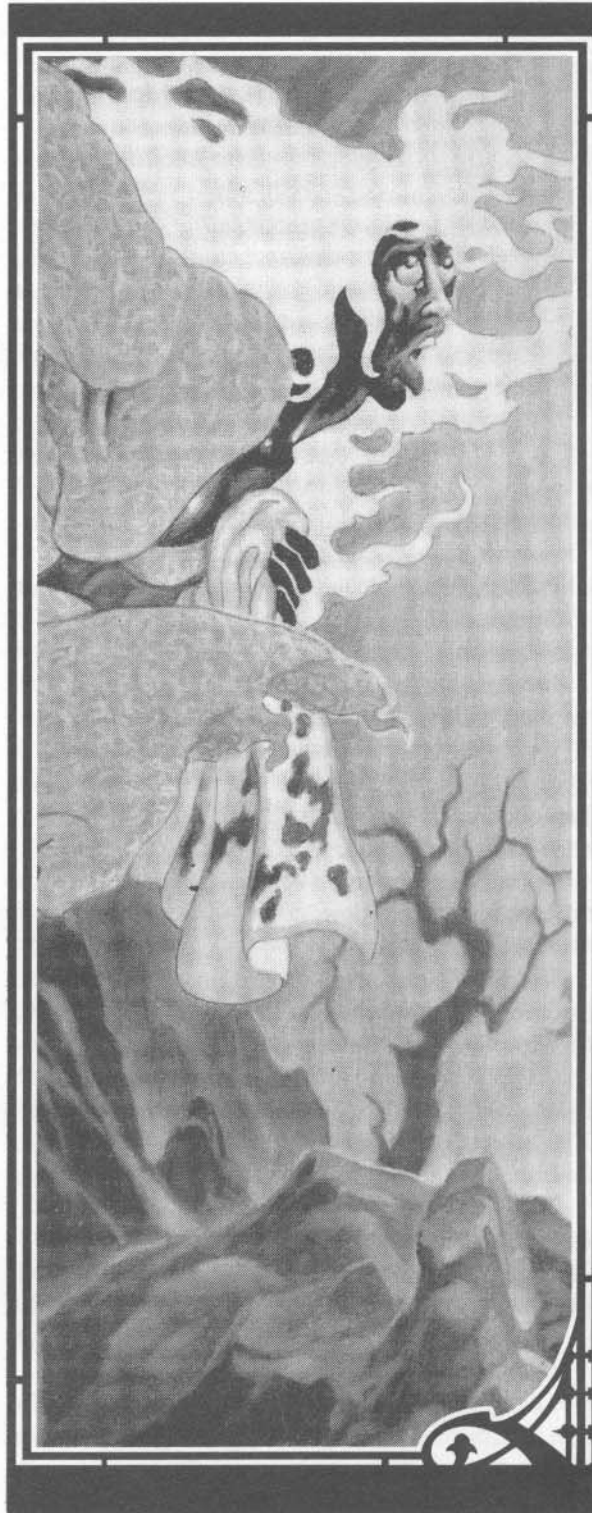

## U: THE DRUIDS—NATURE'S LAST HOPE



*venge, O Lord! Thy slaughter'd  
Saints, whose bones  
Lie scatter'd on the alpine  
mountains cold;  
Even them who kept thy truth  
so pure of old  
When all our fathers worshipt  
stocks and stones.*

—John Milton

When Forfar entered Ravenloft, most of the humans in the land were metamorphosed into goblins and eventually fell under total control of the lord of the domain. The only people to avoid this evil fate were those

who followed the druidic calling. These were but a handful of the humans who inhabited this once-populous domain, perhaps 80 in total.

Today, 188 years later, even fewer druids remain. Although the original druids produced offspring and recruited promising candidates from neighboring domains when they could, the persecution of their faith (which Tristen began in earnest in Forfar year 2009) has taken its toll. Many of the druids died and some have fled Forlorn for “safer” domains. Today, only 42 druids of various levels remain.

The druids of Forlorn maintain an unbroken tradition that stretches back to the time before this land entered the demiplane of dread. They still refer to the land as Forfar and reckon time by the old calendar. To the druids, it is the year 2122, regardless of what inhabitants of the neighboring domain of Barovia might say.

The druids believe that they alone were spared and allowed to maintain their original, untainted human form because they remain in perfect balance with nature. Absolutely neutral in alignment, they favor neither good nor evil, at least on a philosophical level. To adventurers, however, the druids may appear to be a force for good, since they actively struggle against Tristen and his evil minions. In fact, the druids seek only to restore balance to the land, which has tipped

heavily to the side of evil.

There are two schools of thought on how this balance might be restored, and so there are two factions of druids in Forlorn. One is led by an elder druid named Shelaugh and the other is led by a young druid named Maeve. (Druids give up their last names, and all clan alliances, in an effort to maintain strict neutrality.)

Shelaugh believes that the way to restore harmony to Forlorn is to reduce the number of evil creatures in the land through direct attack. Her faction, which has 28 followers, takes the red berries of the rowan tree as its symbol. The rowan is a druidic symbol of wisdom and power, and it is often called the “tree of life.” It represents the rowan faction’s belief that the evil in Forlorn must be actively suppressed before life will return to balance.

Maeve, on the other hand, believes that the proper way to restore balance to the land is to bring more creatures of good alignment into the domain. Her followers agree that directly fighting evil is not a suitable task for those of neutral alignment, and they believe that the forces of good should instead be built up to the point where they will naturally begin to counter the existing evil. This faction, which has just 12 devout followers, takes the oak leaf as its symbol. The oak is a symbol of strength, durability, and protection, and it also is a powerful fertility symbol. It represents the oak faction’s belief that good creatures must be encouraged to be fruitful and multiply.

Although the two factions employ different philosophies and strategies, they work toward the same basic goal—cosmic balance—so they maintain an amicable relationship. They share, for example, knowledge and use of Sanctuary, and they come together for ritual observances.

Nevertheless, Shelaugh and Maeve surreptitiously strive to steal members from one another’s factions. A druidic player character who makes contact with the priests of Forlorn eventually will be expected to choose a faction and stick to its methods. Druids who side with the rowan faction will be



## U: THE DRUIDS—NATURE'S LAST HOPE

expected to use their powers to fight Tristen and his minions, while druids who side with the oak faction will be expected to aid in bringing more good creatures to the domain and to encourage characters of good alignment to take up residence there.

### Shelaugh

#### 12th-Level Human Druid, Neutral

Armor Class	4 ( <i>leather armor +2, cloak of displacement</i> )	Str 16	Dex 12	Con 11
Movement	12	Int 12	Wis 13	Cha 17
Hit Points	52			
THACO	14			
No. of Attacks	1			
Damage/Attack	1d6+5 ( <i>staff-spear +4, plus Strength bonus</i> )			
Special Attacks	spells			
Special Defense	see below			
Magic Resistance	nil			

Shelaugh has bright red hair, which she wears bound in a long braid that hangs down her back. Woven into this braid are a number of white feathers and red glass beads that are shaped like rowan berries. Shelaugh wears a traditional brown kilt and an off-white blouse, covered by a dark brown, hooded cloak. On her feet are knee-high boots of soft brown leather. Her sporran is trimmed with gray rabbit fur. When waging war against evil, she wears leather armor. She is armed at all times with an oak-wood staff that is actually a magical weapon. A holy symbol of Belenus hangs around her neck (see page 47).

**Background:** Born in Forfar year 2069 in the caves known as Sanctuary, Shelaugh is the daughter of two druids of renown. When she was just seven years old, her father was captured by Tristen's goblin minions, taken to Castle Tristennoira, and there tortured and killed. Shelaugh's mother died in a vain effort to free her husband.

Shelaugh is a surviving member of the ApFittle family. Tristen believed that he killed the last of the ApFittles in 1934, but he failed to consider that there were members of this clan among the druids. Were she not a druid, Shelaugh would have a claim to the barony, but her religious calling prevents her from claiming that title.

The priestess of nature is absolutely devoted to the idea of restoring the land's balance by reducing the evil it contains. This idea was first proposed by her parents, but it was under Shelaugh's stewardship that the cause gained a sizable following. Until Shelaugh came into her own as a powerful leader (she was in her early 30s at the time), the druids were content to focus their efforts on the preservation of the land's remaining sacred groves.

**Current Sketch:** Shelaugh is leader of the rowan faction, which believes in combating evil directly in an effort to restore the balance of the land. She and her 28 followers worship the Celtic god Belenus (see "Gods of the Druids," page 47).

Tireless in her efforts to reduce evil in the land, Shelaugh often leads nightly prayer circles that seek to summon the Wild Hunt (see page 49). On other nights she takes up the battle herself, leading a handful of her most devoted followers in a direct attack against the forces of evil. (The typical targets of these attacks are small groups of goblins or wolves, or a lone worg.) While in this pursuit, these druidic hunting parties often mimic the actions of the Wild Hunt—even to the point of the participants wearing small sets of antlers on their heads.

Shelaugh hopes to become strong enough one day to confront the ghostly lord of the domain inside his castle stronghold. To this end she has been petitioning her god for spells that can be used in combat. For two decades Shelaugh has worked diligently to reduce the amount of evil in the domain of Forlorn. There have been both victories and defeats. Now 53 years old, Shelaugh knows that her youthful vigor is starting to fade. She realizes that her

## U: THE DRUIDS—NATURE'S LAST HOPE

assault on the castle must come in the next few years, but she doesn't yet consider herself strong enough to confront the lord of Forlorn. Instead, she battles his minions, hoping to reduce the power of the land first.

When she does at last enter the castle, Shelaugh will have one additional goal: she has sworn to locate the bones of her parents and lay them to rest in one of the sacred groves.

**Combat:** Shelaugh wears *leather armor +2* and fights with a *staff-spear +4*. Her Armor Class is further reduced by her *cloak of displacement*. She attacks fiercely, either with weapon or with spell, depending upon the situation, but she will break off the fight and flee rather than face death or capture. Only rarely does Shelaugh face this situation, however. She has a number of magical items at her disposal. The 10 red beads in her hair are *beads of force*. She also carries a *wand of enemy detection* and wears a *ring of fire resistance* that was passed to her from her mother. This gold ring, like a holy symbol of Belenus, features a quartz crystal with a glowing spark of fire inside it. The ring does not, however, function as a holy symbol.

Shelaugh's spells tend to be those useful in combat, mostly offensive or healing spells. Many of them come from the sphere of fire, sacred to the sun god Belenus.

**Favored Spells (7/5/5/3/2/2):** *Bless, combine, cure light wounds, detect snares and pits, entangle, faerie fire, shillelagh; bark skin, flame blade, obscurement, produce flame, trip; flame walk, hold animal, locate object, plant growth, summon insects; cure serious wounds, neutralize poison, produce fire; air walk, wall of fire; fire seeds, heal.*

As a worshiper of Belenus, Shelaugh also has the ability to cast *continual light* on command. Also, Shelaugh's bright red hair gives her the innate ability to cast three 1st-level spells and one 2nd-level spell. Her innate magical abilities include *analyze balance, animal friendship, pass without trace, and trip*. (See "Spellcasting

Abilities of Redheads," page 44, for details.) Of course, Shelaugh enjoys all of the powers bestowed upon a druid of her level, as listed in the *Player's Handbook* (except the ability to learn the languages of woodland creatures).

### Maeve

#### 10th-Level Human Druid, Neutral

Armor Class	7 ( <i>amulet of protection +3</i> )	Str	12
Movement	12	Dex	13
Hit Points	44	Con	15
THACO	14	Int	14
No. of Attacks	1	Wis	16
Damage/Attack	1d4+2 ( <i>sling of seeking +2</i> )	Cha	15
Special Attacks	spells		
Special Defense	see below		
Magic Resistance	nil		

Maeve is a woman with brilliant carrot-orange hair that is very curly and hangs in tight ringlets down her back. She has wide shoulders, a round face, and large calloused hands—typical characteristics of those of "peasant stock." Maeve wears the brown kilt of the druids, but it is decorated with cloth patches cut in the shape of oak leaves, in colors of red, yellow, and orange. She also wears a beige blouse, knee socks, and low soft-leather boots. A braided leather thong around her forehead holds back her hair.

**Background:** Maeve was born in the Forfar year 2093 (Barovian year 706) in Teufeldorf, a town in the neighboring domain of Gundarak. For years she thought her parents were no more than simple peasants. Of the nine children in her family, only Maeve had red hair. Her father, who had auburn hair, always hinted that Maeve's red hair made her "special," and he warned her against ever setting foot in the domain of Forlorn (which he called Forfar). Should she ever travel there, he warned, she would become a target for goblins, but he never explained why.



## U: THE DRUIDS—NATURE'S LAST HOPE

When Maeve reached her teens, she began to display more than the usual amount of teenage rebelliousness. Sneaking away from her parents' farm one day, she joined a party of woodcutters who had decided to brave Forlorn's foreboding forests. As soon as she stepped across the border, Maeve felt a strange tingling in her mind, but she gave it no thought. As usual in Forlorn, it was a wet, miserable day as the company paused to eat their midday meal. Maeve intended to make some soup in a pot, but the wood was too damp to start a fire. She was desperately hungry, but they had only raw potatoes and onions to eat.

Then Maeve noticed that the metal pot was beginning to magically heat in her hands! In the space of a minute or two, it had become so hot that she had to set it down. In no time, the soup was bubbling away. Maeve didn't realize it then, but she had engaged her innate ability to *heat metal* (see "Spellcasting Abilities of Redheads," page 44, for details).

When Maeve returned home, she was confronted by her father, who was furious that she had disobeyed his orders and had entered Forlorn. Maeve stood up to him, angrily demanding that he explain her strange power, at which time he broke down and confessed that he was a former druid who had fled Forlorn years before she was born. He explained the nature of her genetic inheritance, telling her all about the abilities of redheads to cast spells and about the few druids in Forlorn who still struggled to uphold their faith and restore balance to the land.

Disgusted by her father's rejection of his faith, Maeve abandoned her parents' farm the next morning. It was her destiny, she told her parents (as evidenced by her carrot-orange hair) to take up the druidic faith. She had to follow her calling and so, at the age of 16 years, Maeve entered Forlorn. Some say it was luck alone that pointed her stumbling feet in the direction of one of the sacred groves; others say it was the will of Daghdha (see "Gods of the Druids, page 47). In any case, the

druids took one look at her hair and accepted Maeve as one of their own.

Now 29 years old, Maeve has devoted the past 13 years to restoring balance to the land. Because she comes from a farm family, she speaks of her efforts in terms of "seeding the land with good," or "raising a crop of good to balance the harvest." She is especially adept at tending plants, and she is often consulted when the time comes to locate and replant the oak and rowan seedlings that spring up across Forlorn during each equinox and solstice.

**Current Sketch:** Maeve is leader of the oak faction, which believes in increasing the number of good creatures in Forlorn in an effort to restore balance to the land. This faction worships the Celtic god Daghdha.

Although Maeve is relatively young, her great devotion to her cause has earned the favor of Daghdha and allowed her to rise through the ranks quickly. However, because she is younger than Shelaugh, Maeve has had less time to build a following. Her faction tends to attract older druids who have tired of Shelaugh's ceaseless battles against evil and who have decided that a different approach must be tried.

**Combat:** Maeve avoids combat whenever possible, preferring to focus on creating and nurturing good. She chooses to avoid evil, rather than confront it, but when forced into battle she is more than able to defend herself. She wears an *amulet of protection +3* (functions as a *ring of protection*) in the form of a silver acorn that hangs on a leather thong around her neck. She also wears a *robe of blending* and carries a *sling of seeking +2*.

Most of Maeve's spells are based around summoning and persuading creatures of good alignment to settle in Forlorn. But she also has a number of defensive spells to protect herself from goblin and wolf attacks.

**Favored Spells (6/6/3/3/2):** *Animal friendship, cure light wounds, detect magic, detect poison, locate animals or plants, purify food and drink; charm person or mammal, goodberry,*

## U: THE DRUIDS—NATURE'S LAST HOPE

*messenger, slow poison, snake charm, speak with animals; locate object, speak with dead, tree; animal summoning I, hallucinatory forest, plant door; animal summoning II, atonement.*

As a worshiper of Daghdha, Maeve can accurately predict the weather up to one full week in advance and cast *heroes' feast* once per day. Maeve's carrot-orange hair gives her the innate ability to cast three 1st-level spells and two 2nd-level spells, including *bleed*, *create water*, *pass without trace*, *augury*, *heat metal*, and *sanctify*. (See "Spellcasting Abilities of Redheads," page 44, for details.) Like Shelaugh, Maeve possesses all powers ascribed to a druid of her level as listed in the *Player's Handbook* (except the ability to learn the languages of woodland creatures).

All druids of Forlorn are fairly similar in appearance, and adventurers will usually have some difficulty distinguishing between the two groups. Keen observers may notice the faction symbols worn by the druids. These may include a tiny embroidered symbol on a kilt, a cloak pin in the shape of either a berry or a leaf, or an embossed design on the leather of a sporran or belt. All druids wear plain brown kilts and cloaks, soft hand-sewn leather boots, and sporrans made of stag hide. Within their sporrans the druids carry mistletoe and tiny caches of medicinal herbs.

Like druids elsewhere, those in Forlorn are limited to leather armor. If they carry a shield, it must be wood. Preferred weapons include the club, dart, spear, dagger, sling, and staff.

The druids of Forlorn have long flowing hair that is usually tied back or bound into a thick braid. (Druids allow their hair to grow freely and "find its own balance.") Male druids sport unkempt, thick beards. Even the casual observer will quickly notice that the majority of druids in Forlorn have red hair. In some, this coloration is as bright as a carrot, while in others the hair is predominantly brown, but it still has a distinct auburn tint.

### Spellcasting Abilities of Redheads

Indeed, druidism and red hair have been closely associated in this land for centuries. The greatest druids, it is said, have hair of the brightest orange-red hue. This is more than mere myth. Redheaded humans born in Forfar have always exhibited innate spellcasting abilities. Said to have been granted by the land itself, these natural talents manifest themselves as the redheaded children grow. Generally speaking, the brighter the shade of red in the hair, the more naturally he or she comes by the spontaneous powers. It also takes "true" redheads less time to discover their abilities.

A person with an auburn tint typically acquires the equivalent of a single first-level spell and rarely discovers the ability before reaching adolescence. A person with bright, carrot-orange hair might wield several 1st- and 2nd-level spells, and he or she might discover this talent as early as age four or five.

These talents manifest themselves outwardly in the color of an individual's red hair, but they are not dependent upon the hair itself—rather, it's a genetic trait present in redheads. Thus, cutting a redhead's hair, or even shaving him or her bald, does not preclude these innate spellcasting abilities.

Naturally, the danger of not training redheads to use their powers wisely was quickly recognized in Forfar, and such children were often given over to the druids to be raised. Among these priests and teachers the children could learn the necessary discipline and "balance" needed to use their talents in an appropriate manner.

Because druids seldom marry outside their faith, their offspring are mainly children with red hair. Normally, when two redheads marry, only one in four of their offspring will have red hair, but most of the druids of Forfar trace their redheaded ancestors back centuries. Hence, when two redheaded druids marry, three out of four offspring are themselves redheaded.



## U: THE DRUIDS—NATURE'S LAST HOPE

Gifted redheads are able to use each of the spells granted to them *twice* in any 24-hour period—once during daylight hours and once during the night. They need not pray to receive spells, and they need no spell components or holy symbols. The only requirement is that they be within the borders of Forlorn and that they consciously will the spell to happen. All spell effects manifest as if they had been cast by a druid of the same level as the gifted character (in terms of range, duration, area of effect, saving throw, and so on), but the casting time for any spell effect is one round.

The shade of red in the character's hair affects the degree of power in the individual. Someone with dark auburn hair may employ one 1st-level spell; with a lighter, reddish-brown

tint, the person wields two 1st-level spells; those with strawberry-blonde to pale-red hair may use two 1st- and one 2nd-level spell; if the character's hair is distinctly red, he or she may "cast" three 1st- and one 2nd-level spell; and for the person with carrot-orange hair, three 1st- and two 2nd-level spells are granted. Of course, the Dungeon Master must decide upon the exact shade of the characters' hair, and he or she is free to adjust the number of granted spells to suit the individual campaign.

The spells that manifest in the redheads of Forlorn are strictly druidic in nature and are drawn from the following priestly spheres: All, Animal, Divination, Elemental, Healing, Plant, and Weather. Available spells are listed in the tables below for the DM's convenience.

**Table 3: 1st-Level Spells**

Roll	Result
1d20	Result
1	Reroll
2	Analyze balance*
3	Animal friendship
4	Bless/curse
5	Combine
6	Create/destroy water
7	Cure/cause light wounds
8	Detect good/evil**
9	Detect magic
10	Detect poison
11	Detect snares and pits
12	Entangle
13	Faerie fire
14	Invisibility to animals
15	Locate animals or plants
16	Log of everburning*
17	Pass without trace
18	Purify/putrefy food & drink
19	Shillelagh
20	DM's choice

**Table 4: 2nd-Level Spells**

Roll	Result
1d20	Result
1	Augury
2	Barkskin
3	Charm person or mammal
4	Detect/undetectable charm
5	Dust devil
6	Find traps
7	Flame blade
8	Goodberry/badberry
9	Heat/chill metal
10	Know/undetectable alignment**
11	Messenger
12	Obscurement
13	Produce flame
14	Sanctify/defile
15	Slow poison
16	Snake charm
17	Speak with animals
18	Trip
19	Warp/straighten wood
20	DM's choice

\* Spell is from *Tome of Magic*.

\*\* Spell is altered when cast in Ravenloft. See the *Rule Book* in the RAVENLOFT® boxed set.

## U: THE DRUIDS—NATURE'S LAST HOPE

Unfortunately, Tristen is well aware of this link between druidic abilities and red hair. As part of his persecution of the faith, he has given his goblin minions standing orders to capture (at best) or kill (at worst) anyone with even a hint of red in their hair. Sometimes these captives turn out to be druids. Others are simple travelers with no connection whatsoever to the druids of Forlorn.

### Redheaded Player Characters

Actually, even children born outside of Forlorn have the potential for innate spellcasting abilities. Redheaded player characters or nonplayer characters may be distantly related to Forfar's druids and may thus have these skills, but they will be completely unaware of them. Only when they enter the domain of Forlorn will their talents awaken. In game terms, the Dungeon Master may choose to grant these abilities to player characters who have any shade of red hair *and* who have some element of a quasi-British background. (They should at least trace their ancestry back to a highland country. Given the setting of most medieval fantasy campaigns, this should not be difficult, but such lineage is purely the DM's prerogative to grant or deny.)

Non-natives of Forlorn who are gifted redheads discover their innate abilities once they enter that domain, when the Dungeon Master deems to announce the discovery. Typically, a time of need will trigger a spell effect. For example, a redhead might discover the ability to *cure light wounds* while binding the wounds of an injured comrade. In game terms, the DM should secretly determine which spell-like ability a character has when the party enters Forlorn. Then, when an opportunity to use that ability arises, the character makes a Wisdom check, and a successful roll indicates that the spell effect occurs. A character who is aware of the ability and fails the check will be unable to "cast" the spell for one hour, but he or she may try

repeatedly, with one-hour delays between each attempt, until successful.

### The Sacred Groves

The druids of Forlorn tend not to venture far from the few remaining sacred groves of the domain. In these tiny remnants of the land's once-mighty forest, they worship, meditate, and gather the mistletoe, herbs, and edible plants that fuel their spells and sustain them.

Among other reasons, the druids guard these sacred groves with their lives because these patches of original forest are the only places in which they can commune with their Celtic gods, who can only barely sense the druids' pleas for power within the Shadow Plane. (Contact with the Outer Planes, where the gods reside, is all but severed for those in the Shadow Plane. The power needed to pierce those planar boundaries must be amplified by praying upon hallowed ground, which in Forlorn exists only in the sacred groves.) While the druids are able to cast spells anywhere in Ravenloft, they may gain new spells or pray to memorize known ones only within the sacred groves.

The druids do occasionally venture into the blighted forests of Forlorn to hunt the animals that remain there and to travel between the sacred groves or to the secret caves known as Sanctuary. They also travel the length and breadth of Forlorn during their four holy days—the two equinoxes and two solstices. During that time they collect as many of the sprouting oak and rowan saplings as they can, replanting them in areas adjacent to the sacred groves. In this way, the druids hope to expand their holy ground. One day they hope to restore the forest from one end of the domain to the other. The druids are unaware of the fact that Tristen lies sleeping during these holy days, but they have noticed that his goblin minions are less active on these occasions.

The druids of Forlorn have all of the abilities ascribed to that class in the *Player's Handbook*, except the ability to learn the languages of



## U: THE DRUIDS—NATURE'S LAST HOPE

woodland creatures, which are not native to Forlorn. (Over time, with their separation from the Prime Material Plane, that ability has eluded them.) In addition, the Forlorn druids have developed a secret language. Of necessity due to Tristen's persecution, this language is not a spoken one. It consists of a series of intricate hand gestures with which the druids convey even complex ideas in utter silence.

### Gods of the Druids

**O**f the original Celtic pantheon of ten intermediate gods and one greater god worshiped in Forfar, only two gods are still revered. The rest (with the exception of Arawn, whose name is revered by the goblins) have vanished from memory.

The druids of Forlorn mainly worship Belenus, the god of the sun and fire, and Daghdha, the greater god of the Celts who is associated with weather and crops. For full details about these gods, see *Legends and Lore* (2108). The druids honor both gods, but as a general rule they call themselves priests of either one or the other, and they draw spells from that god only. The druids of either god are granted major access to the following priestly spheres: All, Animal, Elemental, Healing, Plant, and Weather. They are also granted minor access to the sphere of Divination.

### Belenus

Shelaugh's rowan faction swears allegiance to Belenus, whose power over sunlight and fire can be used in a direct attack against evil, especially the undead. Although the druids themselves have no turning ability, clerics of Belenus fashion holy symbols that are powerful weapons against the undead of Forlorn, if wielded by a cleric of good alignment. Indeed, these are the *only* holy symbols that have any effect against the lord of the domain.

Holy symbols of Belenus take the form of clear crystals suspended on a chain or thong that is worn around the neck. Inside each crystal

is a flickering red or golden light, said by the druids to be a "fragment of the sun." The crystals may be of any type, but clear quartz crystals are preferred.

Held in the hands of a cleric of good alignment, a holy symbol of Belenus can be wielded to turn or destroy foul, undead creatures. As a side effect, however, these holy symbols will flare to a brilliant light in the presence of the living dead, forcing all characters within 30 feet who are not shielding their eyes to save vs. spell or suffer temporary blindness and attack with a penalty of -1 to -4 for 1d4 rounds. This affects even the person wielding the holy symbol. The druids will warn their friends and allies of this side effect.

While the druids of Forlorn who worship Belenus can create holy symbols, these are not required for them to cast their spells, but they can be used for this purpose, as a substitute for mistletoe. (Those priestly spells that list "holy symbol" as a spell component require mistletoe for a druid, but all of Forlorn's priests of nature typically carry this plant in their sporrans.)

All worshipers of Belenus have the ability to cast *continual light* on command. In other worlds, these followers also can cast *enchant stones* (see *Legends and Lore*), but this spell is unknown among the druids of Forlorn.

### Daghdha

Maeve's faction follows Daghdha, who is known for his bottomless cauldron filled with food and drink. The oak faction sees Daghdha as a source of good things that can be used to balance the preponderance of evil in the land.

First-level worshipers of Daghdha are granted the ability to accurately predict the weather up to one full week in advance. In practice this might seem futile—the weather of Forlorn is almost always wet, rainy, and cold. However, there are a few days during which the clouds part enough to let in the pale, watery light of the sun, and it is often useful to know before venturing out of doors whether the rain will intensify to a downpour.

# U: THE DRUIDS—NATURE'S LAST HOPE

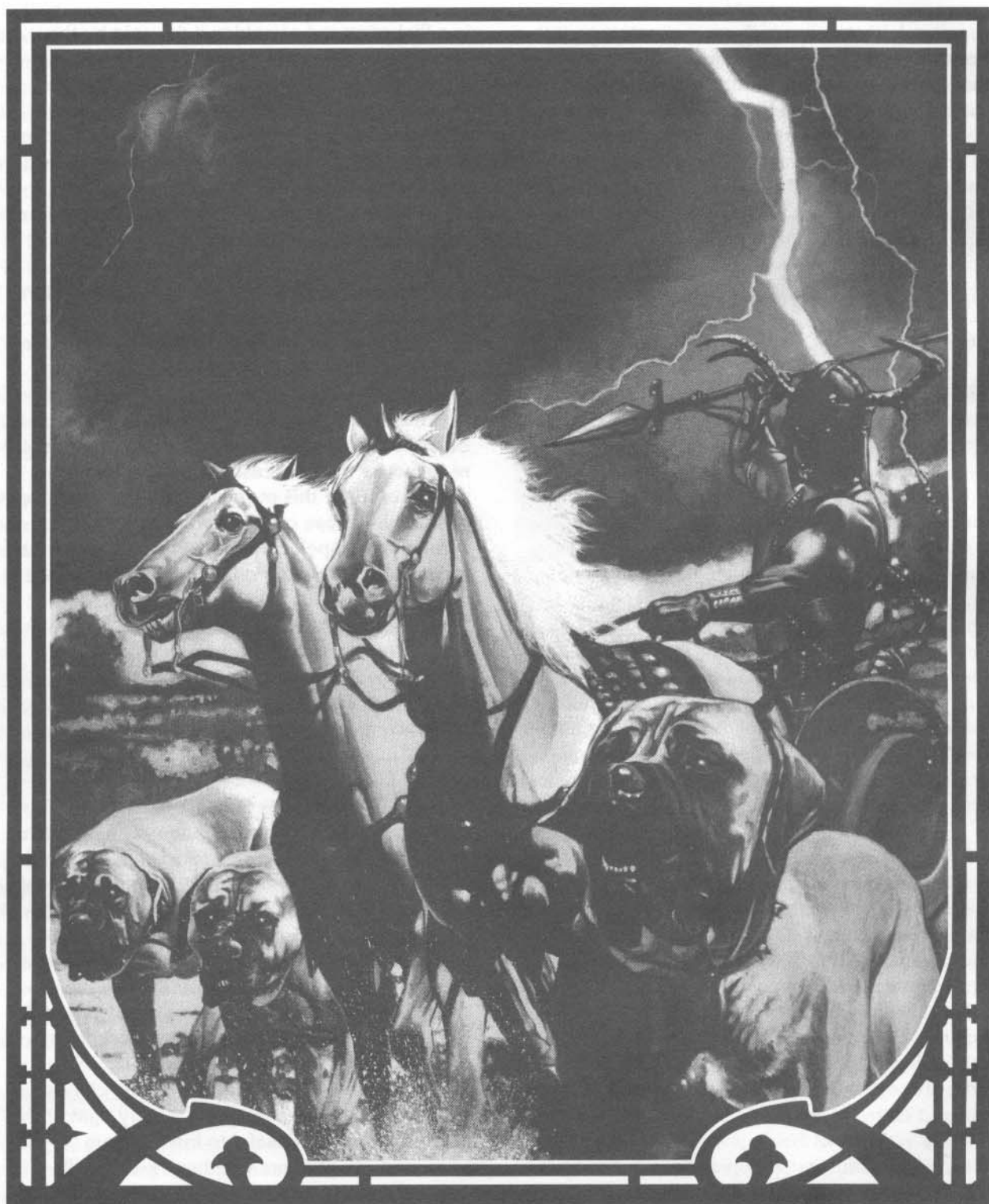



## U: THE DRUIDS—NATURE'S LAST HOPE

Eighth-level worshipers of Daghdha are granted the ability to cast *heroes' feast* once per day. Given the scarcity of flora and fauna in Forlorn, this can be an essential spell.

### The Wild Hunt

In Celtic lands that lie within the Prime Material Plane, there is a powerful force acting for good, known as the Wild Hunt. This mystical occurrence manifests itself as a pack of 20 huge dogs whose eyes glow green and whose panting breaths produce jets of green flame; they are called the Pack of the Wild Hunt. The hounds are guided by a dark-skinned man who runs behind the Pack on foot, and he wields an enormous spear. He wears a distinctive black helmet crowned with antlers, and he is known to the druids of Forlorn as "the horned god," but Celtic worshipers across the Prime Material Plane know him as the Master of the Hunt. The druids of the rowan faction consider him to be a god because he represents perhaps their best hope to challenge and destroy Tristen ApBlanc. (Technically speaking, the Master is a Celtic hero rather than a god.)

When the Wild Hunt appears, the howls of the Pack can be heard for some distance, as can the call of the Master's horn. Although the hounds are a force for good, their mournful yowls are the stuff of which nightmares are made. The Wild Hunt seeks out the nearest source of evil and immediately begins a pursuit of terror and ferocity.

All druids and characters of good alignment who see the Hunt must successfully save vs. spell or be compelled to join in the hunt, regardless of its direction or prey, accepting the Master as their leader. Becoming as one with the hounds that make up the Pack, these characters gain the ability to run tirelessly until the prey is sighted. All members of the Hunt then must fight until either the prey or they lie dead. During their servitude to the Wild Hunt, player characters obey only the commands of the Master and have no will of their own, but they may continue to run their characters and

participate in the Hunt unless the DM decides that they are not properly role-playing the situation. Indeed, in the race to hunt down and rend evil, PCs lose the ability to think clearly and often fail to use their normal abilities. A spellcaster, for example, fights with dagger or bare hands beside the hounds, rather than casting spells.

The Master and Pack of the Wild Hunt are immortal. When "killed," their bodies simply vanish from sight, slowly turning to mist. If the Master is killed, or if the chosen source of evil is destroyed, the Wild Hunt disappears, returning to the place from whence it came and releasing enchanted characters.

The druidic faction that follows Shelaugh knows well the legend of the Wild Hunt, and its members fervently pray for the appearance of the horned god each night. However, there is only a 15% chance of a manifestation on any given evening, and the Wild Hunt may occur but once per night.

What the druids don't realize is that the horned god and the dogs who occasionally show up are actually a product of Ravenloft itself, and not the true Master and Pack of the Wild Hunt. This shadow-planar Wild Hunt behaves in all respects like the real thing, except it is unable to discern good from evil. Instead, it drives across the countryside with a terrifying ruckus until it flushes out any nonanimal, identifies the unfortunate creature as evil, and then pursues it to its death.

This can be an unfortunate happenstance if the PCs are the first creatures detected by the hunt. If such is the case, the saving throw vs. spell is negated as the PCs become the prey. If part of the party remains hidden from the Hunt, then those screened characters must make the saving throw and may find themselves hunting their own companions to the death.

The druids don't realize that their Master and Pack of the Wild Hunt are a deception of the land because characters of absolutely neutral alignment are magically exempt from being identified as prey, so none of them have ever been hunted

## U: THE DRUIDS—NATURE'S LAST HOPE

down. Neither does this demiplanar Wild Hunt ever pursue the lord of the domain, so Shelaugh's hopes of destroying Tristen this way are forever denied, and she has no idea of the truth.

### Master of the Wild Hunt

Armor Class	0	Str	18/00
Movement	18	Dex	18
Hit Dice	20	Con	18
Hit Points	200	Int	17
THACO	1	Wis	17
No. of Attacks	3	Cha	9
Damage/Attack	1d6+9 ( <i>spear</i> +3, plus Strength bonus)		
Special Attacks	nil		
Special Defense	nil		
Magic Resistance	25%		

### Pack of the Wild Hunt

Armor Class	2
Movement	21
Hit Dice	5 each
Hit Points	30 each
THACO	15
No. of Attacks	1
Damage/Attack	2d4
Special Attacks	see below
Special Defense	see below
Magic Resistance	15%

Special attacks of the Pack include the ability to cause *fear* (as the spell) in any mortal the Pack is pursuing. The Pack also can swarm its enemies, giving each of the hounds an attack, no matter how limited the space. In addition, each hound can use its green flame breath to inflict an additional 5 points of damage upon any attack that hits (once per turn).

Special defenses include the equivalent of a permanent *protection from evil* spell.

### A Springboard to Adventure

The Wild Hunt may be used as an excellent way to introduce the player characters to Forlorn. It is an especially interesting and effective way to

pull them into the demiplane of dread from other worlds. Whether they are already in Ravenloft or in some other world, the DM might read the following boxed text to the party after nightfall.

It's a black night, thick with mists that stand like walls, trapping you within them, yet keeping nothing out. Silence has descended upon this foreboding night, and even the shift of your foot against the ground echoes in the void around you.

Something catches your attention: a noise just within earshot. If you hold your breath, you can almost make it out. . . . There it is again—a hunter's horn, blowing somewhere in the darkness. It sends a tingle up your spine that spreads outward and down to the tips of your fingers and toes.

The horn sounds again—closer this time—and your blood begins to pound in your head, leaving you hot and restless. The horn trumpets a third time, closer than ever, and you leap to your feet with a burst of energy. "The Hunt!" whispers a voice within you. "The Hunt!" you cry.

Instruct the players to attempt a saving throw vs. spell. If all of them successfully save, announce the sounding of the horn twice more (closer to the group each time) and require the PCs to save each time. If and when anyone fails their saving throw, they are enchanted as described above and will bolt into the mists, urging the party in high spirits to follow them. They then join the Wild Hunt, which leads them on a merry chase directly into Forlorn. (Any henchman or other NPC will automatically fail the third saving throw.)

If the entire party successfully saves every time, or if they otherwise successfully avoid the call of the Master's horn, then they are detected by the Pack and become the prey of the Hunt. When the fight ends, the PCs are in Forlorn.

For a detailed description of the Wild Hunt, see Legends and Lore.



## U: THE DRUIDS—NATURE'S LAST HOPE

### What the Druids Know of Forlorn

Several of Forlorn's druids have been captured by goblins and taken to Castle Tristennoira, where they were imprisoned and tortured to death, but a very small number of them have escaped. These individuals possess a limited amount of information about the castle and its otherworldly inhabitants. They can describe the cells in its dungeons in detail, but they are hazy on the other areas. And they have only caught very brief glimpses—and then through blood-gummed eyes—of the ghosts that populate its halls. They cannot provide an accurate picture of Tristen, and they do not know his name or any of his attributes.

The druids have passed down memories of the way the current domain of Forlorn used to look, back when it was Forfar. They will describe, for example, the land on which Tristen's castle is situated, saying that what now is a cliff of red granite used to be a gentle hillside, crowned with a holy grove.

The druids have also preserved a little of the history of the domain, although they're sketchy on many details. Questioning the druids will reveal only the following legends (and not a detail more!):

- In the Forfar year 1594, a holy grove that lay where the castle now stands was temporarily profaned when a young woman of the ApBlanc clan was hung there by a mob from the village of Birnam.
- In the year 1609, a druid named Rual was murdered in the grove. Her son tried to fend off the attackers, but he failed and was grievously wounded himself. Thereafter, the grove became a place of evil and was abandoned.
- A keep was built on the site in the year 1809 by a bard called "the minstrel ApBlanc." He married and raised a family, but one by one the members of the family died, due to a horrible curse. Not even the young minstrel survived.

- The keep was expanded into a full-fledged castle in the early 1900s by Marc ApBlanc, a descendant of the young minstrel. This Marc was a determined young man who usurped the rule of the ApFittle family in a series of civil wars. He triumphed over the ApFittles in the early 1930s and became clan chief.
- In 1934, the "Time of Terrors" changed the land forever. As the land was violently reshaped by some evil magic, Marc, like the rest of Forfar's population, was transformed into a goblin.
- Goblins rebuilt the castle about one century ago. They now make it a base for their operations. They seem to be under the control of a ghostly lord. The druids have no clear idea of why the lord is persecuting them, but they believe that he wants evil to reign supreme in Forlorn, so he's removing any who might provide a force of good to balance it.



## UI: CASUALTIES OF LOVE



*e did not wear his scarlet coat,  
For blood and wine are red,  
And blood and wine were on his  
hands  
When they found him with the  
dead.*

—Oscar Wilde

This chapter contains some of the most important NPCs in Forlorn. Each member of the ApBlanc family is detailed, plus Rual, who was Tristen's adoptive mother. All of these characters are ghosts of various magnitudes, and *Van Richten's Guide to Ghosts* will be

immensely useful in running them, but all facts and statistics necessary to running the game are included in this booklet.

Ghosts in general are immune to any spell or magical item that affects biological processes, due to their nonbiological physiology and the fact that they exist on an entirely different plane. Magical weapons may find the ethereal mark, but this is a concession that allows nonpriests to have some effect upon these otherwise invulnerable monsters. Good DMs will bear in mind that these are dangerous beings and bring woe to PCs who shrug them off!

### **Wizard spells that are useless vs. ghosts:**

*Avoidance, blindness, cloudkill, contagion, deafness, death, death fog, energy drain, finger of death, haste, hold animal, hold monster, hold person, irritation, magic jar, Otto's irresistible dance, polymorph any object, polymorph others, power word blind, power word kill, power word stun, sink, sleep, slow, vampiric touch.*

### **Priest spells that are useless vs. ghosts:**

*Animal growth, cause blindness, cause deafness, cause disease, hold animal, hold person, regenerate, restoration, speak with monsters.*

## Flora ApBlanc

### 1st-Magnitude Ghost, Neutral Good

Int	12
Armor Class	0 (8 vs. ethereal opponents)
Movement	15
Hit Dice	2
Hit Points	10
THACO	19
No. of Attacks	1
Damage/Attack	see below
Special Attacks	see below
Special Defense	hit only by weapons of +1 enchantment of higher
Magic Resistance	Nil
SZ	M (5' 2" tall)
ML	Average (9)

Flora ApBlanc appears in all three Castles Forlorn. She is a fair-haired woman with aristocratic features and fine clothes. When sighted, she will usually be running at top speed, her hair flowing behind her. As she runs, she casts frantic looks back at unseen pursuers and occasionally utters a woeful cry.

At first glance, Flora seems simply to be an incorporeal version of her former self, in a long dress with a sash bearing the ApBlanc tartan (white with green stripes), a short-sleeved blouse, and a shawl.

Closer inspection of this ghost reveals two important details. First, she is carrying a small bundle, nestled to her bosom. Second, her neck bears the rough red marks of a rope.

**Current Sketch:** Flora became a ghost because of the anguish she suffered wondering if her child would survive the mob that lynched her. She is doomed to forever repeat the events leading up to her death that wintry night in Forfar 1594.

The ghostly Flora is anchored to a path leading from the ruins of Birnam to the spot on which Castle Tristennoira now stands. She retraces the same route each time she appears, never varying from it, and her appearances are cyclic in nature. She begins her frantic run each night at the same time (11 PM)—the hour when



# VI: CASUALTIES OF LOVE

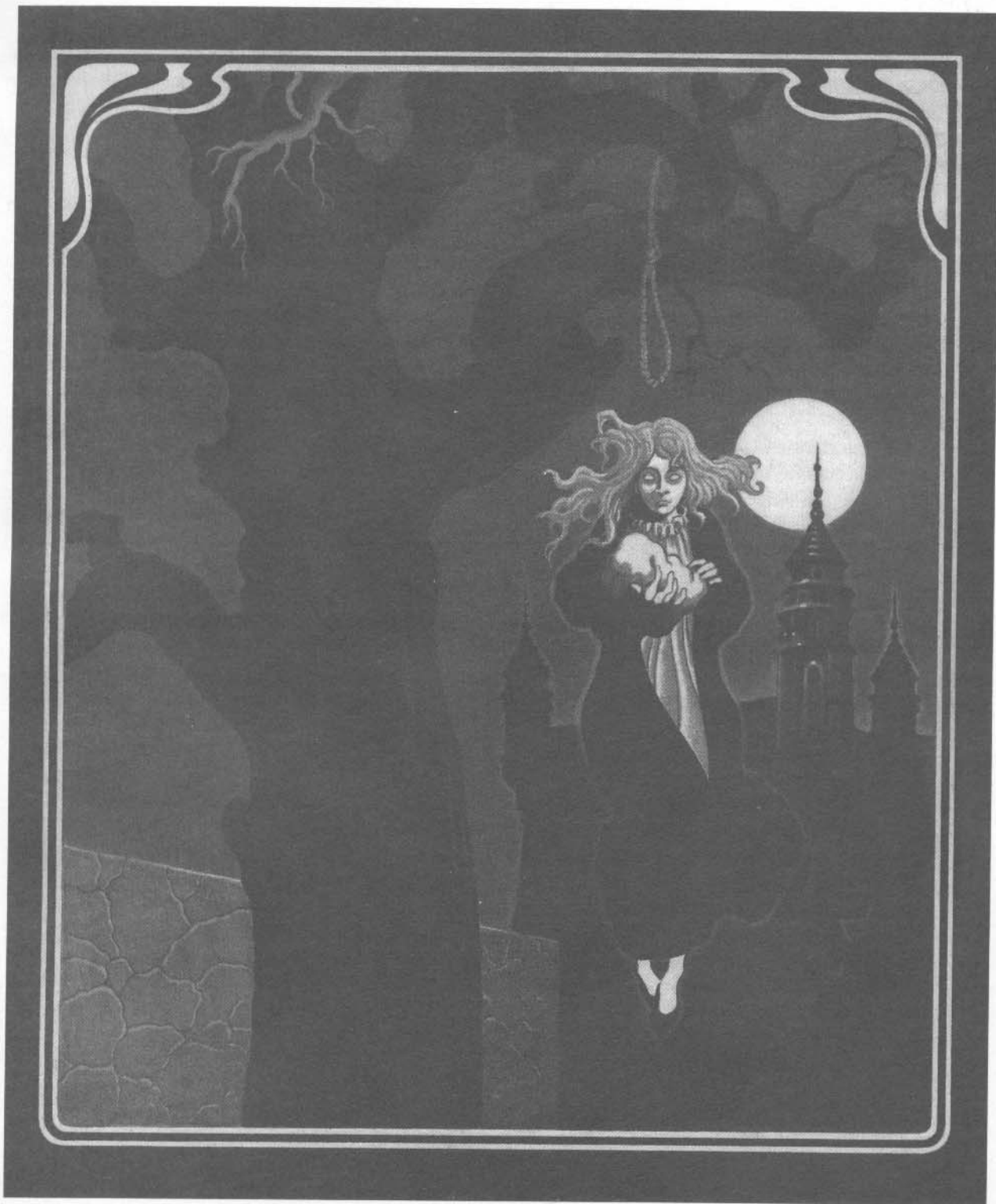

## VI: CASUALTIES OF LOVE

the mob smashed open the door of old ApBlanc Hall and pursued her up the hill to the sacred grove. Materializing in the ruins of Birnam, she races up an invisible hill, climbing steadily toward the castle that now perches upon red granite cliffs. As she runs, the shouts of an angry mob echo through the air. Sometimes the sound is accompanied by the flickering images of phantom torches.

Having reached the area of the castle, Flora runs through it, passing through walls and other solid objects that stand in her way. Once she reaches the site of the grove, she stands beneath the sacred oak and searches for a suitable person to give the child she carries in her arms.

If Flora encounters a player character, she presses the bundle into that person's arms, wailing in a plaintive voice, "Please! Hide my child! They mean to kill—" She glances fearfully behind her at this point, as the sound of the approaching mob rises. "They're coming for me!" she continues. "For the love of the gods, Rual, save my child!"

If questioned, Flora will only repeat her last statement. Whether an adventurer accepts the bundle, a ghostly noose suddenly slips over her head and violently yanks Flora off her feet, snapping her neck to the side. She then swings in the wind (regardless of whether it is actually blowing) for about a minute, hanging from a rope that fades to nothingness before it reaches the oak tree overhead. If the bundle is not accepted, the blanket unrolls as Flora is hung, releasing a puff of mist. If it is accepted, the bundle lingers long enough for the holder to open it and see an angelic-looking baby. This scene may prompt a horror check if the PCs fail to respond appropriately.

**Combat:** Flora has no true attack, and her only form of defense is her ability to *entrance victims*. Unless those who view her successfully save vs. paralysis, they will stand helplessly, watching Flora until she has passed them by. Victims are able to make another saving throw every round until successful.

Flora may be hit only by magical weapons having a +1 or greater enchantment. (Opponents able to assume ethereal form may use nonmagical weapons; Flora's Armor Class in this case is 8.)

Unlike other ghosts, Flora does not have either the ability to become invisible or to rejuvenate lost hit points. If "killed" on a particular evening, she will vanish into mist only to reappear the next night, at the stroke of eleven o' clock.

Holy water may be used to injure Flora; she suffers 1d10 points of damage from it. She can not, however, be turned by any priest, for she is completely unaware of anything around her. Indeed, she will run right through anyone who stands in her way!

For more details on Flora ApBlanc's background, see Chapter I.

### Rual

#### Druid of the Sacred Grove

#### 4th-Magnitude Ghost, Neutral Evil

Int	17
Armor Class	-3 (2 vs. ethereal opponents)
Movement	14
Hit Dice	10
Hit Points	52
THACO	11
No. of Attacks	1
Damage/Attack	see below
Special Attacks	see below
Special Defense	hit only by +3 weapon
Magic Resistance	see below
SZ	M (5' 7" tall)
ML	Elite (13)

Rual appears in any of the three Castles Forlorn. Due to the emotionally charged nature of her murder at Tristen's hands (which occurred in the Forfar year 1609), Rual has returned from beyond the grave as a ghost of the fourth magnitude. Her sole purpose in returning to the world of mortals was to seek vengeance, and



## VI: CASUALTIES OF LOVE

her presence in Castle Tristenoira is a constant thorn in Tristen's side.

At the time of her death, Rual expended a great deal of energy casting upon Tristen the curse that forever bound him to the site of the sacred grove. She now exists only as an incorporeal, vaporous spirit. Devoid of any features, Rual has the appearance of a swirling cloud of mist.

Whenever Rual appears, a bubbling, choking sound can be heard. Careful listeners will be able to determine that this sound is similar to the strangled noises of a person whose throat has been slit. When the ghostly Rual departs, a few drops of fresh blood can be found on the spot where her apparition appeared.

**Current Sketch:** Betrayed by the boy she once called her son, Rual now seeks bitter vengeance against Tristen. Whenever she can, she thwarts his plans, terrorizing those who serve him and offering what assistance she can to his enemies.

Although she is not confined to the castle like Tristen, Rual tends to spend most of her time there. She has developed a perverse enjoyment from watching Tristen's feeble efforts to escape the bonds of her curse.

Tristen has attempted to attack Rual several times, but she's too powerful to control while he's in vampire form, and the extraordinary powers he has in ghostly form are ineffective against another ghost. This leaves him with the prospect of hand-to-hand combat with Rual, and the ghosts are too evenly matched for Tristen to take this desperate measure.

For her part, Rual has learned Tristen's greatest weakness—his reversion to mortal form and his deep slumbers on each of the equinoxes and solstices—yet she has never taken advantage of this opportunity to kill him. Instead, she prefers to leave him alive and in perpetual torment. Thus, while Rual will aid player characters up to a point, she will not allow Tristen to be killed.

Because she can neither speak nor gesture, Rual is unable to communicate with adventurers

using normal means. Instead, she uses her ability to *lure victims*, leading characters in the direction she wants them to go. *Lured* victims must successfully save vs. spell or be irresistibly drawn toward the ghost; magical defense adjustments (see Table 5 in the *PHB*) apply. Anyone who attempts to restrain the victim will be violently attacked. Rual's *lure* has a range of 400 feet, but it can be heard from as far as 1,200 feet away, which might prompt an adventurer to investigate it.

Rual's particular *lure* takes the form of an enticing odor. The exact nature of the smell takes a different form with each victim. To a priest, it might be the perfume of holy incense; to a warrior, it might be the scent of roasting meat and freshly poured ale; to a druid, it might be the smell of woodland flowers. Only the affected character can detect these smells, and the nature of the odor will be different in each case.

**Combat:** Rual can be hit only by magical weapons of +3 or greater magical enchantment. (Opponents in ethereal form need only +1 weapons; in that case Rual's Armor Class is 2.)

Due to the amount of energy she expended in casting her curse, Rual in ghostly form is not as strong as other spirits of the fourth magnitude. She is unable to become invisible at will, so her only means of escaping an adversary is to pass through walls or other solid objects. (If Rual passes through a wall, a fine spray of fresh blood marks the spot.) She is, however, immune to all spells of a biological nature (see page 52 for a list of those spells). Rual has the ability to rejuvenate back to full hit points at will, but this process takes two full rounds. After rejuvenating, she cannot perform any action for six turns.

Due to her evil nature, Rual's god has stripped all druidic spells from her, but she does have several extraordinary powers that result from her ghostly status. First and foremost of these abilities is her power to *lure victims*, described above.

## VI: CASUALTIES OF LOVE

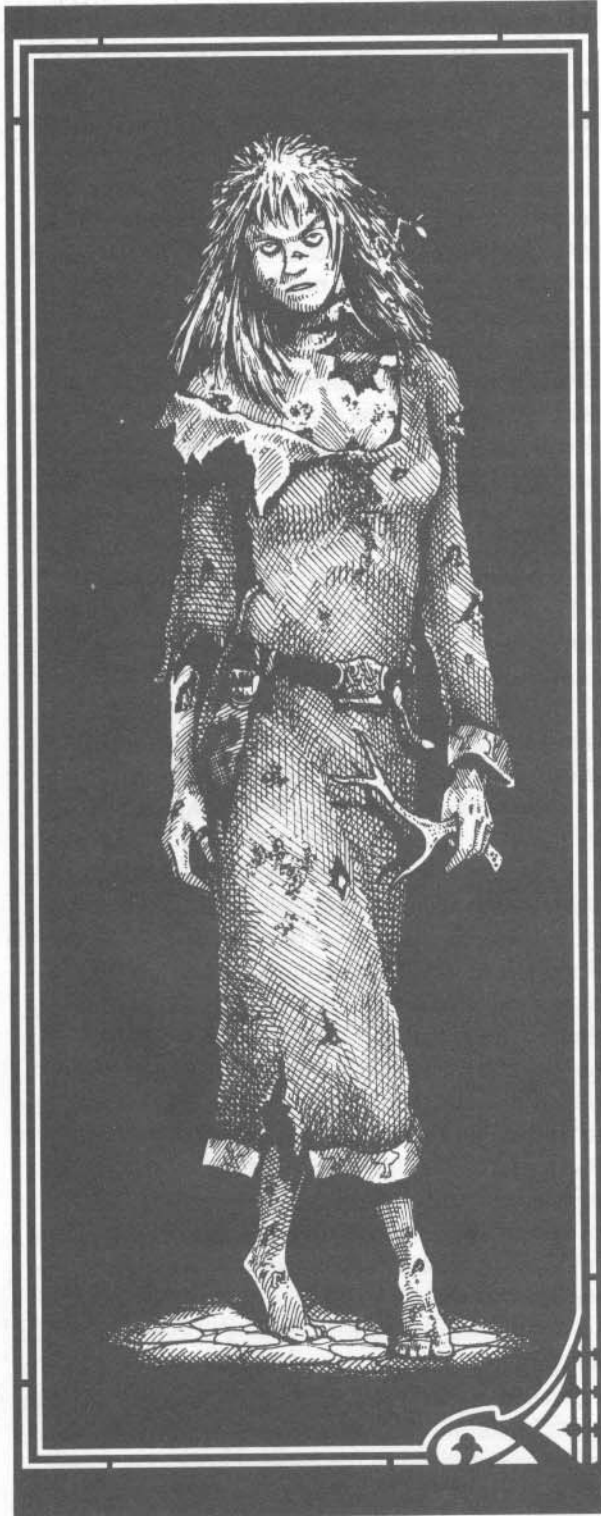

Because she was once a druid, Rual also has the ability to *charm animals*. This ability mimics the *charm person* spell, except it affects only animals and can be used at will. Rual can command up to 30 Hit Dice of animals. The only animals immune to this effect are the wolves and worgs of Forlorn.

Rual can *create illusions* at will, and she delights in using this ability to torment Tristen by creating an illusion of the sacred grove that once covered the spot where Castle Tristenoira now stands. It is a continuing reminder of her curse, and it is absolutely convincing, for Rual's illusions affect the senses of sight, sound, touch, and smell (treat the illusion as a *hallucinatory forest* spell). Rual is limited in the subject matter of her illusions, however; the sacred grove is the only illusion she can create. She can modify it slightly, varying the placement of the animals and plants it contains, but she cannot add anything that would not normally be found in a sacred grove. Likewise, she is unable to populate it with any humans, except for an illusion of herself. The image of Rual contained within the illusion provides the ghostly Rual's sole means of communicating with Tristen or others. Through it she can speak and gesture normally. However, adventurers may not listen to anything she has to say, for Rual is only able to create an illusion of herself as she would appear in death: a ghastly, corrupted corpse with a gaping wound in its neck, vacant eye sockets, and worm-eaten flesh. Worse yet, whenever this image appears within the illusion, the sacred grove behind it shifts, taking on the appearance of one of the patches of cleared ground that scars the domain. Player characters who see this may be prompted to make a horror check.

Rual can be turned by any priest with that ability. However, she is turned with a  $-2$  penalty to the priest character's die roll, due to her status as a fourth-magnitude ghost. Note that because of Tristen's *sinkhole of evil* effect (see page 16), an additional penalty of  $-2$  is assessed to turning attempts within Castle Tristenoira ( $-4$  total).

For more details about Rual, see Chapter I.



## VI: CASUALTIES OF LOVE

### Isolt ApBlanc

If the player characters meet her in Castle A, Isolt will be mortal. At some point in their exploration of that time period, however, she will have been thrown from the Lord's Tower and turned to a ghost. Her stats and description are listed as a mortal first, and as a ghost second.

#### 3rd-Level Cleric, Neutral Good

Armor Class	10	Str	12
Movement	12	Dex	13
Hit Dice	3	Con	17
Hit Points	21	Int	12
THACO	20	Wis	16
No. of Attacks	1	Cha	16
Damage/Attack	1d6 (mace)		
Special Attacks	spells		
Special Defense	spells		
Magic Resistance	nil		

Isolt ApBlanc appears as a mortal in Castle A only. She is a woman who is noted not so much for her beauty as for her healing abilities as a cleric of the Celtic god Diancecht. Still, she is comely, although her appearance is marred by a downturned mouth and creases at the edges of the eyes that betray an immense inner sadness.

Now in her mid-40s, Isolt has long brown hair that she wears coiled in a large bun at the back of her head. Earlier portraits of her show that she once had a perfect figure; now her waist and hips have broadened somewhat after bearing three children.

Isolt wears a kilt in the tartan of her family, the ApVays. Its pattern is a gold, red, and blue plaid. She also wears a long-sleeved white blouse trimmed with lace at the cuffs, knee-high socks, black slippers, and a light-brown cloak. She wears the symbol of her god (a silver arm) concealed under her blouse on a silver chain.

**Background:** Of all of the women of Birnam who caught the eye of the young "minstrel ApBlanc" (Tristen), Isolt was the only one who held it. At first, she felt nothing stronger than friendship for the charming young man who summoned her time and time again to his keep.

When he first proposed to her, she refused to marry him, saying her duties to her god were more binding and important.

Tristen convinced Isolt to marry him by revealing his dark secret to her, hoping that pity would win her heart. When he told her he was a vampire by day and ghost by night, he feared she would react with horror and loathing. Indeed, he was quite prepared to kill her should she threaten to reveal his secret, but his gamble paid off. Tristen's plaintive plea for Isolt to heal him found a soft spot in her heart. This, Isolt thought, would be her greatest challenge as a healer. If she succeeded, she would gain great favor in the eyes of Diancecht.

Before he would let her attempt a cure, however, Tristen asked Isolt to swear by all that was holy that she would marry him, regardless of the outcome of her spells, and she foolishly agreed. And, of course, nothing cured her fiancé. She failed both her future husband and her god. Still, Isolt honored the terms of her promise and married Tristen, even though she now knew him to be no mortal man.

**Current Sketch:** In the time period of Castle A (Forfar year 1839), Isolt is a bitter, melancholy woman. Both of her sons are dead and her daughter has just disappeared in the last year. Isolt knows that Tristen was responsible for the death of Morholt and suspects he deliberately caused the death of Gilan as well. She also suspects that her husband had a hand in their daughter's disappearance.

After her marriage to Tristen, Isolt was unable to keep up her clerical studies, so she achieved only the 3rd level of experience as a priestess of Diancecht. She still honors the healing god, though, and on nights when there is a new moon she slips out of the castle to one of the many sacred groves that dot Forfar, to burn herbs in Diancecht's honor.

Isolt tried to raise her children to honor and respect the Celtic gods. Her success with Gilan, the eldest son, was nominal, for he preferred a life of play to one of worship. Her second son, Morholt, showed greater respect for divinity, but

## VI: CASUALTIES OF LOVE

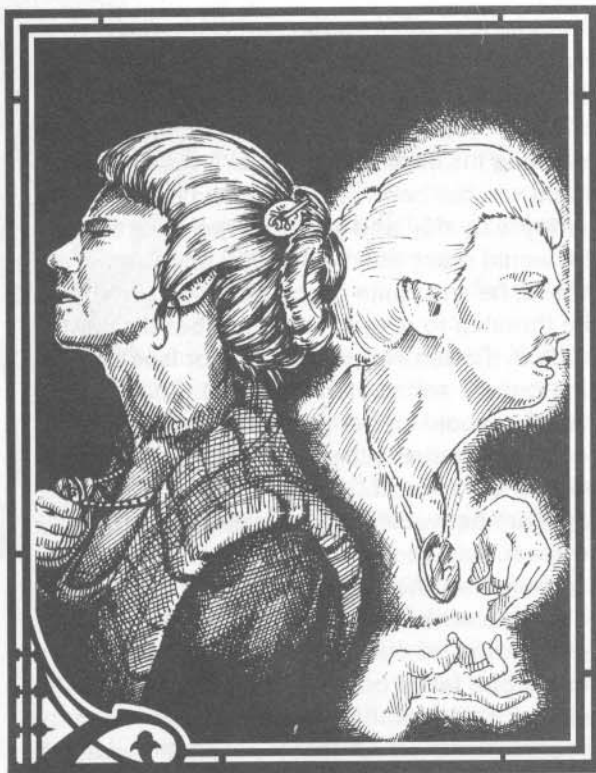

he chose a god with a darker aspect—Morrigan, goddess of war.

Isolt's daughter Brangain, however, followed in her mother's footsteps. Although she was just 22 at the time of her disappearance, Brangain's abilities had already passed those of Isolt; she was a 4th-level cleric of Diancecht. The recent disappearance of her daughter has devastated Isolt.

**Combat:** Because Isolt follows the healing arts, she has vowed never to inflict wounds or cause pain unnecessarily. If threatened, she can defend herself with a mace. She wears no armor.

**Favored Spells (4/3):** *Cure light wounds, detect poison, locate animals or plants, slow poison; augury, goodberry, withdraw.*

As a worshiper of Diancecht, Isolt can cast spells from the sphere of Healing as if they were one level lower than normal. For example, *cure serious wounds* becomes a 3rd-level spell. Priests of Diancecht cannot turn undead.

### 3rd-Magnitude Ghost, Neutral Evil

Int	12
Armor Class	-2 (4 vs. ethereal opponents)
Movement	12
Hit Dice	7
Hit Points	31
THACO	13
No. of Attacks	1
Damage/Attack	see below
Special Attacks	see below
Special Defense	hit only by weapons of +2 enchantment of higher
Magic Resistance	nil
SZ	M (5' 5" tall)
ML	fanatic (17)

Isolt appears as a ghost in all three castles, although she appears first as a mortal in Castle A. Isolt's death severed her ties with her beloved god Diancecht, for priests of that sect are committed to life and healing. When she died, she passed beyond her god's sway, which is a source of greater anguish than all the woe of her miserable life with Tristen.

The anguish and grief that Isolt felt as she died turned her into a ghost of the third magnitude. She has assumed a semicorporeal state; most of her body is incorporeal, but her arms from the elbow down are apparently solid.

The ghostly Isolt looks just as she did at the time of her death. Her body is intact and preserved, but it appears to have taken a long fall—her limbs are broken and contorted, yet she still moves (with a wobbly gait). Those who examine her arms will see numerous, recently healed punctures there; these look as if they had been made with the point of a knife.

Isolt still wears the holy symbol of Diancecht on a chain around her neck, but the silver arm has tarnished to a mottled brown color.

**Current Sketch:** Isolt ApBlanc returned from beyond death's veil out of devotion to her missing daughter. In Castles B and C, she wanders the halls of Castle Tristennoira, trying to solve the mystery of Brangain's disappearance.



## VI: CASUALTIES OF LOVE

Her ghostly voice echoes along the corridors, calling her daughter's name. Isolt is doomed to search the castle until her daughter is found. She doesn't realize that this is a hopeless task, for Brangain disappeared from the dungeons of the castle (where she had been held for nearly a year) in the same year that Isolt died, 1839.

Isolt is single-minded in her task. Although she was traumatized by her husband's foul deeds, she has no time to spare for malicious thoughts or deeds against him. She no longer interacts with Tristen, nor does she pay any heed to the ghosts of her two sons. Isolt knows that none of them can answer her desperate queries as to the fate of her beloved daughter.

Isolt questions all visitors to the castle. She will describe Brangain and ask if they've seen her. If the answer is a clear "no," Isolt instantly vanishes. If the answer is vague, or if PCs pretend they know Brangain, Isolt will not give them a moment's peace until they reveal her whereabouts. Should the visitors then reveal that they were lying and that they have no real knowledge of her daughter, Isolt will fly into a rage, using her powers to offer up horrible torments. Should the visitors actually offer information on Brangain's whereabouts, Isolt will choose the most capable-looking of the group and use her power to *inhabit bodies* (see below) to take over that person's body in an attempt to reach her daughter.

**Combat:** Like most ghosts, Isolt is able to become invisible at will and is immune to all spells of a biological nature (see page 52). She can pass through solid objects at will, despite her semicorporeal arms and hands. She is also able to rejuvenate back to full hit points at will in one round; this, however, renders her unable to perform any action for 30 minutes.

Isolt can only be struck by magical weapons with a +2 enchantment or better. (Foes in ethereal form need only a +1 or better weapon; in this case, Isolt's Armor Class is 4.)

The ghostly Isolt has a variety of powers at her disposal. As described above, she can

*inhabit bodies*. This power duplicates that of the 5th-level wizard spell *magic jar*, except that there is no receptacle used. Thus, when Isolt invades the body of a host, that person's life force is utterly destroyed and death results.

Isolt can try to inhabit the body of any mortal within 60 feet. The victim is entitled to a saving throw vs. spell, but with a -3 penalty. (If the intended victim is shielded by a *protection from evil* spell, Isolt's attempt is unsuccessful.) Isolt will then use the body to find her daughter, no matter how long this takes. Driving her from the victim's body (for example, via *dispel magic*) will only produce an empty, lifeless shell; only a *resurrection* spell will recall the spirit.

Because of the depth of her melancholy, Isolt exudes an aura that can *cause despair* in those within a 100-foot radius. Victims who fail to save vs. spell become depressed and lethargic. They become convinced that all is lost and that there is no hope of accomplishing whatever task they were about to perform. Victims of this aura suffer a -2 penalty to all saving throws, attack rolls, and proficiency checks until they move beyond the radius of effect.

Finally, Isolt has retained some of her spellcasting abilities, but in a twisted, evil form. Where once she used her talents to heal, she now uses them to cause pain and suffering.

**Spells (3/2):** *Cause light wounds*, *obscure poison* (reverse of *detect poison*—blocks a priest's efforts to determine whether something is poisoned), *accelerate poison* (reverse of *slow poison*—failure to successfully save results in instant death); *badberry*, *withdraw*.

Isolt can be turned by holy symbols, but priests attempting to do so suffer a -1 penalty to their rolls. (Within Castle Tristenoira, an additional -2 penalty applies, for a total of -3.) If struck by holy water, she suffers 1d6 points of damage.

## VI: CASUALTIES OF LOVE

### Gilan ApBlanc

#### 2nd-Magnitude Ghost, Chaotic Good

Int	13
Armor Class	-1 (6 vs. ethereal opponents)
Movement	16
Hit Dice	4
Hit Points	22
THACO	17
No. of Attacks	1
Damage/Attack	see below
Special Attacks	see below
Special Defense	hit only by weapons of +1 enchantment or higher
Magic Resistance	nil
SZ	S (4' 6" tall)
ML	unsteady (7)

Gilan's ghost may be encountered in all three castles. This pathetic little ghost takes the form of a young boy perhaps 12 years old, carrying the corpse of a small dog in his arms. The boy has fair, tousled hair and an angelic face. He wears a kilt with the ApBlanc tartan (white with green stripes) and a sporran decorated with the family crest (a mailed fist gripping a white feather), as well as an unbuttoned white shirt whose tails flap around his waist. His bare feet are crusted with mud and dried blood.

The dog in the boy's arms is small, perhaps the size of a terrier, but it's difficult to tell what breed it was. The animal's body is grossly mutilated, as if it has been torn apart by wild beasts. Blood drips continuously from its many wounds and its gaping muzzle, but the drops turn to mist before they hit the ground.

**Background:** Gilan was born in Forfar 1814, one year after the wedding of Tristen and Isolt. Until the twelfth year of his life, Gilan led a happy-go-lucky existence. Beloved of his mother and tolerated by his father (even when he was wreaking mischief), he was oblivious to the evil that was unfolding around him. Even ghosts that already haunted the castle in his lifetime held no terror for him. All of his time was

spent in play with Petित्रieu, a tiny, multicolored dog that was reputed to have magical powers.

Sadly, Gilan's life was to be short, and he was to suffer a tragic end. One morning, in the year 1826, the ghost of Rual decided to use her power to *charm animals* and torment Tristen. Working her magic on Petित्रieu, she caused the little dog to nip at the lord's heels. Petित्रieu did no real damage, but Tristen was enraged all the same. Summoning the wolves in his control, he set them upon the tiny pest.

Gilan saw the whole thing as he was getting dressed that morning. Racing across the courtyard, he threw himself upon the wolves in an effort to save his beloved pet. The wolves turned on the boy, instead.

Startled, Tristen called off the wolves, but it was too late. They had already torn the boy to pieces. Furious, he drew his sword and attacked them without quarter, but this only succeeded in sending a number of the beasts scuttling away from the keep. Some of them still carried pieces of the boy in their slavering jaws as they ran. As a result, there was little of Gilan left to bury.

**Current Sketch:** The savage attack that took Gilan's life drove him mad. His ghost has blocked out all memory of the events of his death and he believes the dog in his arms to be alive. Gilan wanders the corridors of Castle Tristennoira with the dead Petित्रieu in his arms, occasionally setting down the ghostly creature to play with it. Using his innate ability to *perform telekinesis* (see below), he throws sticks or balls for the dog to fetch and lifts meat from tables to feed his pet.

Although he is of good alignment, the ghostly Gilan is highly chaotic. Just as when he was a mortal boy, Gilan delights in playing tricks and practical jokes upon adventurers who visit his home. He enjoys telekinetically lifting swords from scabbards, sliding items out of reach, and placing things in corridors to trip the unwary.

Although his father indirectly caused his death, Gilan bears him no malice. Indeed, he still loves Tristen, but the ghostly Gilan is timid and unlikely to come to his father's defense.



## VI: CASUALTIES OF LOVE

**Combat:** Gilan is absolutely dedicated to protecting his dog, even though Petitcrieu is quite clearly dead. Should anyone threaten his pet, Gilan will fly into a rage and attack that individual without quarter. In this circumstance alone, Gilan is fearless; his morale rises to 19. While Petitcrieu can never be permanently killed, the dog can be made to vanish momentarily if it suffers 4 points of damage. When this happens, the ghostly body of Petitcrieu turns to a faint mist for 1d4 rounds. (Because the dog does not move, treat it as having an Armor Class of 10. Magical weapons of a +1 or better enchantment are needed to strike it.)

Gilan himself may be hit only with magical weapons of a +1 or greater enchantment. (Opponents who have assumed ethereal form may strike him with nonmagical weapons; in this case, Gilan's Armor Class is 0.)

Gilan can become invisible at will and is immune to all spells of a biological nature (see page 52). Due to his incorporeal nature, he can pass through solid objects at will. He is also able to rejuvenate back to full hit points at will within one round—this renders him unable to perform any action for 45 minutes.

Gilan has two special powers. The first is his ability to *charm persons* like the spell of the same name; Gilan can charm up to 8 HD's worth of people. His second power is his ability to *perform telekinesis*. By focusing his energy on an object weighing up to 20 pounds, he can move it in either a gentle, sustained motion or a quick, violent action. This ability is similar to the 5th-level wizard spell *telekinesis*.

Gilan has his vulnerabilities, too. If struck by holy water, he suffers 1d8 points of damage. Within Castle Tristenoira, a penalty of -2 is assessed to priestly turning attempts, but Gilan's magnitude adds nothing to this. His greatest weakness is his terror of wolves. If a wolf appears, he flees as if he has been turned. If he hears a wolf howl (or even a passable imitation of one), he must make a successful morale check or run screaming in terror.



## UI: CASUALTIES OF LOVE

### Morholt ApBlanc

<b>2nd-Magnitude Ghost, Lawful Evil</b>	
Int	9
Armor Class	-1 (6 vs. ethereal opponents)
Movement	12
Hit Dice	4
Hit Points	20
THACO	17
No. of Attacks	1
Damage/Attack	see below
Special Attacks	see below
Special Defense	hit only by weapons of +1 enchantment or greater
Magic Resistance	nil
SZ	M (5' 11" tall)
ML	fearless (19)

Morholt haunts all three Castles Forlorn. He was 18 when he was killed, in Forfar year 1833. Doomed by the sudden nature of his death to become a spirit, the second son of Tristen and Isolt ApBlanc believes he is still alive. (Murdered in his sleep, Morholt never knew who his attacker was.)

Incorporeal in form, Morholt appears from the waist up as he did in life. He has a thick mane of dark brown hair, a broad bare chest, and square shoulders. A fresh tattoo of the crossed swords of Morrigan, Celtic goddess of war, marks the skin over his heart. Well muscled, he was obviously a youth who would one day make a fine warrior. Indeed, he often carries a ghostly bastard sword in his hand.

Across Morholt's stomach, however, is a ghastly wound from which uncoiled entrails hang. From the look of it, the wound was caused by a single slash of a great sword. As a result of the shock of this blow, Morholt's otherwise handsome face is permanently contorted into a look of shock and fear.

Below the waist, Morholt's ghostly body dissolves away into mist. He would be at a loss to explain how he walks without legs or how he lives with a gaping wound in his belly. In fact, he's not even aware of the amputation.

**Background:** Born in the Forfar year 1815 to Tristen and Isolt ApBlanc, Morholt was a youngster who was deeply troubled by his parents' often violent disputes over their children's religious upbringing. He yearned to please his mother by following a religious calling, but he also sought to please his somewhat sinister father.

Morholt walked a delicate tightrope for many years, feigning piety when with his mother and insisting in his father's presence that he scorned Isolt's teachings. All the while, he could tell that neither parent was truly happy with him.

When he reached his late teens, Morholt found a compromise. A chance meeting with Duncan ApDuguid, a priest of Morrigan (the Celtic goddess of war), gave him the answer he was seeking. Morholt's worship of this dark deity would both impress his mother with his devotion and please his father, who sought a darker path for his children. Even better, Morholt's pursuit of the arts of war would take him far from Castle Tristenoira and from his parents' now-constant bickering.

One night in 1833, Morholt invited his new friend to the castle. The pair stayed up long into the night, toasting Morholt's acceptance into the church of Morrigan. In a chivalrous gesture, Morholt offered Duncan his own bed, taking the less comfortable guest bed for himself.

At some time during the course of that evening, Duncan sighted the ghostly Tristen and attacked him in fear and self-defense, using a vial of holy water. Tristen fled the encounter unhurt, yet felt threatened by his confrontation with the priest. When the sun rose the next morning and Tristen assumed his vampyre form, he picked up his sword and made straight for the guest bedroom, intending to find Duncan.

Although the sun was above the horizon, the shutters of the room were tightly closed. In the gloom, Tristen could make out only the dim shape of a sleeping figure. He lifted his sword and struck mightily. Only when he lifted the blanket to inspect his work did he realize that he had killed his own son.



## VI: CASUALTIES OF LOVE

Hurriedly wiping his sword and sheathing it, Tristen slipped from the room. Hiding his own weapon, he slipped into the room where Duncan was sleeping, stole the priest's sword, and smeared it with Morholt's blood. Tristen placed the weapon on the floor beside the sleeping priest, sought out one of the few servants whom Isolt fully trusted, and ordered the woman to awaken his son.

The result was an uproar. Duncan was blamed for Morholt's death and Tristen shouted orders that he was to be slapped into irons and hauled to the dungeons below. Duncan—a skilled warrior-priest—escaped by cutting down several of Tristen's henchmen. Blamed with the murder of a friend and unable to prove his innocence, he fled the land, never to return.

When Morholt's body was prepared for burial, a piece of the weapon that slew him was found in his side. Isolt's servant, who had discovered the bloody sword beside Duncan, whispered in her mistress's ear that the supposed murder weapon had not been notched.

Isolt immediately became suspicious of her husband, so she searched for his sword to see if a shard was missing from it, but she never found the blade. A short time later, the servant who had awakened Duncan apparently leaped from an upper window in one of the round towers of the keep, killing herself.

**Current Sketch:** On the day that preceded his death, Morholt had just been accepted into the priesthood of Morrigan. He believes that the fate that befell him has something to do with the goddess deeming him unworthy in some way. He now seeks to prove himself a worthy follower of this goddess of war.

Morholt spends most of his time within the walls of Castle Tristenoira, although he has been known to appear elsewhere in the domain from time to time. Whenever he encounters a warrior, Morholt picks a fight. Woe to the person he challenges, for Morholt always fights to the death. He scorns any who flee from him as cowards who deserve to die, and he pursues them relentlessly.



## UI: CASUALTIES OF LOVE

**Combat:** Morholt is a difficult target for a lone warrior, due to his ethereal Armor Class and the fact that he can be hit only by magical weapons of a +1 or better enchantment. Opponents who can assume ethereal form can strike him with nonmagical weapons, though, in which case Morholt has an Armor Class of 6.

Morholt fights with a ghostly bastard sword. Whenever this strikes, it engages his extraordinary power to *cause wounds*. These blows inflict 1d6 points of damage and leave permanent, ugly scars. In addition, each wound has a percentage chance equal to the amount of damage inflicted of reducing the victim's Charisma by 1 point.

Characters reduced to 0 Charisma lose the will to live; they must successfully save vs. death or collapse and die. Even if the saving throw is successful, a character whose Charisma score is reduced to 0 is transformed into a broken one, becoming an NPC. Only a *wish* can reverse this.

Morholt is able to rejuvenate back to full hit points at will within one round, but he will be unable to perform any action for 45 minutes.

Morholt also *causes fear*. This power forces any who see him to make a successful fear check with a -1 penalty or drop whatever they are holding and flee as far away from Morholt as possible. Because Morholt cannot control this ability, he sometimes has trouble finding adversaries who will stand and fight when confronted. Having challenged a warrior to a contest of might, Morholt will pursue the fleeing individual, trying to make his intended opponent stand and fight.

Morholt can become invisible at will, but he rarely does so, believing it gives him an unlawful advantage over his opponents. However, he is not adverse to using his insubstantial nature to pass through walls and other solid objects when pursuing a victim.

Morholt is immune to all spells of a "biological" nature (see page 52), but holy water inflicts 1d6 points of damage upon him. He can be turned by a cleric without penalty. (Within

Castle Tristenoira, however, a -2 penalty is assessed to priestly turning attempts.) Having fled from battle if this is accomplished, he will be despondent for 1d4 hours, knowing that the goddess Morrigan will not tolerate fear in her followers, and he will expect to be "struck dead" at any time. During this period of despondency, Morholt will not make any new challenges.

If the sword that killed Morholt is found by PCs (it can be identified by the nick in its blade), it can be used against him. In the hands of a warrior of good alignment, it will inflict permanent damage that will not rejuvenate Morholt, and the sword also can be used like a holy symbol to turn Morholt. In the hands of an adventurer of any other class, it can be used to hold him at bay.

### Brangain ApBlanc

#### 4th-Level Cleric, Lawful Good

Armor Class	10	Str	10 (6)
Movement	12	Dex	12
Hit Dice	4	Con	12 (6)
Hit Points	19 (8)	Int	16
THACO	18	Wis	16
No. of Attacks	1	Cha	17
Damage/Attack	1d4 - 1 (fist)		
Special Attacks	spells		
Special Defense	spells		
Magic Resistance	nil		

Brangain ApBlanc, 23 years old in the time period represented by Castle A (the only castle in which she appears), bears a striking resemblance to her mother. Like Isolt, she has long brown hair and fine features, although her hair is unbound and dirty, and her face is streaked with dirt.

Held in the dungeons below Castle Tristenoira since the summer of Forfar 1838, Brangain now is dressed in rags. Her strength and health are fading, and her skin has a pale, sickly hue. Her voice is hoarse from breathing foul air, and if exposed to even the light of a torch, she will squint painfully.



**Background:** Born in 1816, Brangain showed a keen interest in her mother's faith at an early age. The girl had a natural talent for healing any injured animals she found in the forests of Forfar. Her mother Isolte noticed the affinity for healing and secretly trained her daughter in the worship of Diancecht, the god of healing.

Careful to hide her power from her father, Brangain reached the 4th level of experience by the time she was 22 years of age. Having achieved this degree of competency, she began to experiment more fully with her powers. Full of youthful optimism (and unaware of the fact that her father was a ghost), she set out to rid Castle Tristennoira of its unearthly inhabitants.

As a cleric of Diancecht, Brangain had no power to turn undead creatures, yet in her innocence she sought to "heal" them of their miserable and unnatural state. Against the evil ghost that she never suspected to be her father she stood boldly, defying him to accept her ministrations. Once he even let her cast a cursing spell upon his ghostly form—a

perverted mockery of parent/child bonding. To his lasting surprise, though, he experienced excruciating pain from the spell and it was all he could do to escape her insistent healing hands. Tristen eventually concluded that she could be a dangerous adversary, especially if she were to switch her allegiance to Belenus, the one god whose holy symbols held power over him.

Still aching from the loss of his two sons, the lord was unable to kill his daughter. Instead, he shut her in an almost airless cell, in the depths of the castle dungeon. He sought only to break her faith, and he told himself he would release her when she had forsworn further allegiance to any of the known gods.

Brangain, though she cannot escape the dungeons on her own, remains faithful to her god. Should anyone come to rescue her, she will assume that Diancecht has sent them.

**Current Sketch:** If encountered by adventurers exploring the dungeons of Castle A, Brangain will be in a pitiful state. Weak, hungry,

and dejected, she is on the verge of giving up all hope, thinking that her god has forsaken her. Brangain seeks only one thing—to escape from the castle. She now comprehends some of her father's evil (she knows that he is a vampire, but does not realize that he is also a ghost), and she is desperate to escape his clutches. She also believes her mother to be unaware of Tristen's evil nature, and she plans to present Isolte with evidence of the lord's vampyrisms and persuade her mother to flee with her to a neighboring country.

**Combat:** Brangain is in sad shape. Due to her lengthy confinement, her Strength and Constitution have dropped to 6 and her hit point total has dropped to 10. Because her holy symbol has been taken from her, Brangain is unable to cast many spells. The only form of attack remaining to her is to fight with her fists.

**Favored Spells (5/4):** Cure light wounds, detect poison, locate animals or plants, protection from evil, slow poison\*; augury, charm person or mammal, goodberry, withdraw.

\* As a cleric of Diancecht, Brangain casts this 2nd-level spell as if it were a 1st-level spell.

As an interesting aside, Brangain is the living child of a vampire—perhaps the first one! If and when the PCs help her escape Castle Tristennoira, they will unwittingly unleash a scourge upon the world. Brangain is not a vampire herself, but she will bear vampyric children. Interested DMs may use this idea in a future adventure to create a scenario in which the PCs learn that Brangain Apblanc is the mother of that evil race, either within Ravenloft or without.

## VII: WITHIN CASTLE TRISTENOIRA



*he east was white with the moon,  
The west with the sun was red,  
And there in the house-doorway,  
Stood the brother of the dead.*

—Robert Louis Stevenson

Castle Tristenoira perches on the lip of a red-granite precipice overlooking the Lake of Red Tears. At first glance the castle appears abandoned. Its stone walls are crumbling, tiles have sloughed off the roofs of its buildings, and the courtyard is choked with weeds. Some of the disrepair is attributable to age, but much of the destruction

seems to have been wrought by the devastation that occurred when Forfar was physically wrenched from the Prime Material Plane and deposited in the demiplane of dread. Great cracks run up the walls, and some of the buildings seem to be tipped at slight angles.

There were three phases in the castle's construction, from its first erection in 1809 (on the Forfar calendar) to its last addition in 2009. The first structure is called the Lord's Tower, the second is called Castle ApBlanc, and the third is called Castle Tristenoira. To help the DM keep track of the various incarnations, the buildings are respectively called Castle A, Castle B, and Castle C in the following pages.

The original keep lies to the right of the entrance as PCs enter the grounds, the rectangular keep with an adjoining round tower. This section of the castle is the most decrepit, having been built 125 years before Forfar became Forlorn. The Lord's Tower suffered grievous damage in the cataclysm. Indeed, the structure once featured not one but two towers—a pile of rubble lies where the second one stood. The castle was expanded a century later, when a grand hall, guest tower, and outer walls were added. Finally, some 75 years *after* Castle ApBlanc and the land entered Ravenloft, a barbican and several wooden structures within the walls were added.

A series of caverns beneath the castle were formed by the cataclysm, and these were subsequently explored and expanded at about the same time that Castle Tristenoira was completed.

While Castles A and B were built by competent human masons and carpenters, Castle C was completed by the goblins, who have little building skills. Hence, the stonework is sloppy and ill-fitted, and carvings that adorn them are grotesque and crude. Rooms built by goblins are of odd sizes and shapes.

### Entering the Castle

**F**rom the outside, Tristenoira seems fairly typical, but as soon as adventurers set foot inside, strange things begin to happen. Rooms that are dusty one moment suddenly change, becoming clean and new again. Conversely, a room that is tidy and inhabited may suddenly shift into a desolate ruin. Whole sections of the castle disappear and then reappear again. These odd occurrences are attributed to the fact that Castle Tristenoira exists in three time periods *simultaneously*. Therefore, three versions of the same castle exist in the same space and time, relative to the adventurers.

Because the later castles were expansions of earlier buildings, these three castles have many rooms and corridors in common. As player characters move through the castle, they will experience *temporal shifts*—sudden switches from one time period to another. There's no way for adventurers to control which time period they will wind up in, and no way (save, perhaps, through magical means) to discern what time period they will enter next; they are at the mercy of fate (or, rather, the DM).

Complete details for running an adventuring party from castle to castle (and from time to time) are covered in the *Eve of Sorrows* adventure booklet that is included in this box. The DM should study the first few pages of that resource carefully in order to understand the mechanics of the temporal shift.



## VII: WITHIN CASTLE TRISTENOIRA

### From Time to Time

When adventurers enter the time period of Castle A, they find themselves in the year 1839 (on the Forfar calendar—see page 5 for a time line). The Lord's Tower appears relatively new, having been built just 30 years ago, and it is both furnished and occupied. The NPCs living here include Tristen ApBlanc (who is known as the minstrel ApBlanc and *not* by his true name), his wife Isolt, and their servants. Tristen and Isolt's daughter Brangain disappeared only the year before, and there is still much speculation about her fate. In fact, she is trapped in the dungeons below the castle. The castle also is inhabited by the spirits of Tristen's mother Flora, his adoptive mother Rual the druid, and his sons Gilan and Morholt, as well as several geists and haunts who were victims of Tristen.

Any persons the adventurers meet inside Castle A are human, and most of them are residents of the nearby village of Birnam. They refer to the land outside as Forfar and will say it is the year 1839. The villagers will be surprised at the sudden appearance of unusual-looking strangers in the castle, and they will conduct these visitors to the lord, who will receive them hospitably unless they directly threaten him.

The view outside of Castle A is of rolling green hills and Birnam. In the village, the ApFittle family rules Clan ApBlanc from the former ApBlanc Hall, a small keep. The hill on which Castle A itself is situated is bare and muddy. All trees except the sacred oak have been felled and any new growth is ruthlessly weeded away. The days in this time period are bright and sunny, with only occasional rain, and the nights are clear, revealing the stars.

The atmosphere of Castle A lacks the terror of the later Castles Forlorn. The occasional howl of a wolf can be heard from outside, and residents may tell stories of strange, unliving (zombie) wolves or household pets that have changed into misshapen beasts (gremishkas), but the general feeling is that most troubles are far away, and those that do exist will soon be put right by Lord and Lady ApFittle.

When adventurers enter the time period of Castle B, they find themselves in Forfar year 1934. At this time, the Lord's Tower has been expanded into a full castle with a grand hall, guest tower, and outer walls in addition to the original buildings.

The year 1934 is known to the locals as the "Time of Terrors." It is the year that Forfar was physically wrenched from the Prime Material Plane and thrust into Ravenloft. The construction of Castle B is quite recent—just 25 years old—and the castle is still furnished, but everything is covered with a thick layer of dust and there is a general air of decay. The courtyard was obviously meticulously landscaped in the past, yet now it has fallen into neglect. For several years the castle's maintenance has been forgotten. Instead, all efforts of the castle's inhabitants have been focused on the war with the ApFittles.

Castle B exists in a time period in which the earth is racked by tremors. There are rumblings underfoot and cracks are starting to form in the walls. Several of the keep's windows have broken and the floors are starting to tilt. Pictures have fallen from the walls, and cupboards and shelves have spilled their contents onto the dusty floor. At some time point beyond the PCs' visits to Castle B, the north tower of the keep will collapse, as will several ceilings in other buildings and parts of the castle wall.

Outside, the sky is dark both day and night. Sheet lightning flashes across the sky, and heavy gobs of rain fall. The wailing of terrified humans mingles with the mournful howling of wolves. Worgs scuttle across the tangled ground outside, and evil treants shift their positions every few moments. In the village below, many of the buildings have collapsed and ApFittle Hall is a blackened ruin.

Within the castle, any humans encountered are likely to be Tristen's henchmen. An occasional lost one (see the RAVENLOFT® appendix of the MONSTROUS COMPENDIUM™) may be found wandering the dusty halls. Tristen's minions have imprisoned virtually every

## VII: WITHIN CASTLE TRISTENOIRA

member of the ApFittle family in the castle dungeons, and they are about to put the last of the ApFittles, a paladin named Andrew, to death. Through those dungeons a wererat scuttles, feeding on the poor wretches imprisoned there.

The number of geists and haunts has increased, and tormented spirits that inhabit the castle now also includes the ghost of Isolt ApBlanc.

When the PCs enter Forlorn and approach Castle Tristenoira (Castle C), it is the year 2122 on the old Forfar calendar, and Tristen's goblin minions have erected a barbican and a new approach to the castle. They have also built a number of wooden structures within the walls. The older portions of the castle have been badly damaged by the earthquakes that shook the land when it was violently reshaped by its entry into the demiplane of dread. Portions of the surrounding walls are crumbling and unsafe, the buildings are largely windowless and have huge

cracks running up their walls, and sections of the roof have fallen in. The north tower of the original keep has collapsed and exists only as a pile of rubble.

Within Castle C, the only living humanoids that adventurers will generally encounter are Tristen's goblin minions. Worgs now wander freely in the corridors. The few humans to be found lie in chains in the dungeons below; these are druids who have been captured and imprisoned by Tristen's minions.

All of the ghosts detailed earlier in this book are present, and still more geists and haunts have been added to the ranks of those who haunt the castle. These include several from the ApFittle family, as well as a handful of druids who were tortured to death.

The view out of the windows is of the current domain of Forlorn. Day and night, it is raining. At best, the precipitation slows to a thin drizzle. On many nights, sheet lightning flashes across the sky.

**Side View of Castle Tristenoira  
(not to scale)**

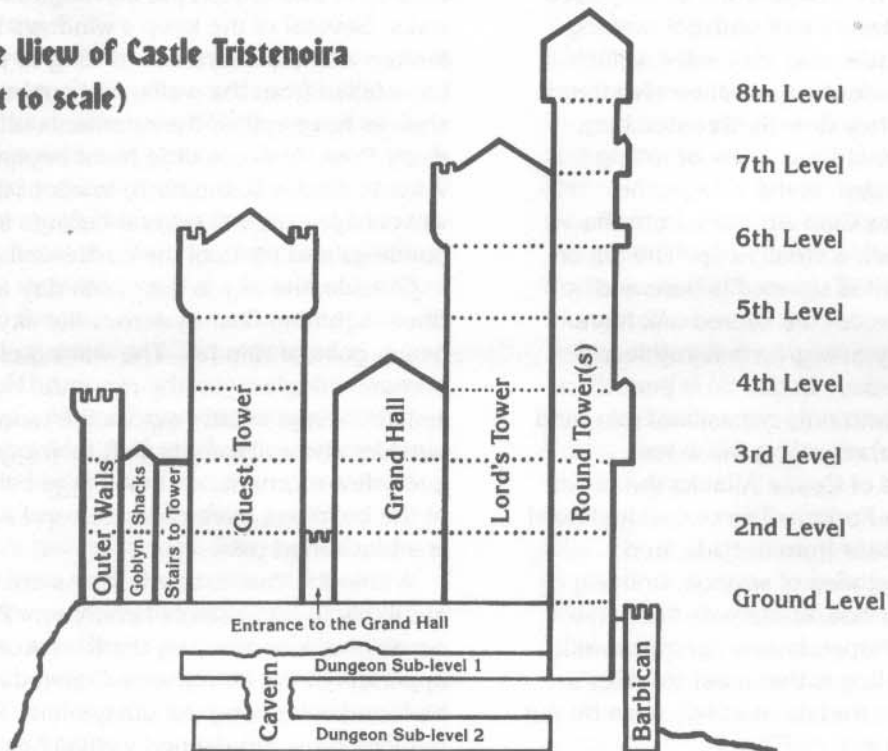



## III: WITHIN CASTLE TRISTENOIRA

### Exploring the Castle

The following room-by-room description of Castle Tristenoira comprises the setting of the *Eve of Sorrows* module that is included in this boxed set. This chapter contains general descriptions only, without any mention of NPCs, monsters, or treasure—for that information, see the module itself. Each area has up to three entries, one for each time period in which it appears.

Rooms and corridors in Castle A are well lit with candelabras or hanging oil lamps. Fires crackle in the fireplaces and most rooms are neat and clean. In Castle B, earth tremors have broken windows and cracked walls, and several ceilings (as well as the entire north tower of the keep) are on the verge of collapse. Only a few of the rooms are lit by crude torches that leave soot stains on the walls. Most of the castle is in darkness, and the rooms and corridors are choked with cobwebs and thick with dust. Castle C is a ruin. Aside from the few rooms that Tristen still occupies, the entire castle is filthy, dark, and in great disrepair. Most are empty and plundered. Goblins occupy the buildings in the courtyard, keeping them in a state of partial repair, and they make use of several of the castle buildings as well.

All tunnels within the castle's defensive outer walls are just 4 feet wide and 8 feet tall, with flat ceilings. Humans must walk through them in a single file, but they can squeeze past each other. Tunnels in Castle B are of recent construction, but they are starting to show cracks from the earth tremors. By the time of Castle C, the tunnels are choked with cobwebs, some of the walls have gaping holes, and portions of the ceilings have fallen in, leaving rubble and dust underfoot.

Spiral staircases within the castle walls are only wide enough to permit humans to climb the stairs in single file. They spiral up clockwise, giving right-handed defenders fighting from a higher step the advantage. (Optional rule: If right-handed, the lower fighter suffers a -1 penalty to attack rolls.)

#### 1. West Barbican Rooftop (C only)

This flat rooftop is surrounded by a chest-high crenelated wall. The crenelations are of odd dimensions: some are wide and square while others are narrow and oblique. A trap door in the floor, which can be bolted shut from this side, gives access to a rusted metal ladder leading down to area 141.

#### 2. East Barbican Rooftop (C only)

Same as 1, except the trap door is missing and the ladder leads down to area 144.

#### 3. Approach (C only)

This sloping ramp begins at the lowest level of the barbican (area 162) and leads up to castle ground level, where a rotten looking drawbridge with rusted chains joins it to the keep. The walls of the approach are crenelated.

#### 4. Dead-end Tunnel (B, C)

**B:** A secret door joins this 35-foot-long passageway to the courtyard (area 37).

**C:** The courtyard can be seen through cracks in the wall. Fallen rubble blocks the secret door.

#### 5. Foyer (A, B, C)

**A:** This room provides a place for travelers to hang their cloaks and warm themselves. The entrance is a heavy door in the west wall that is locked and barred from the inside (successful open doors roll required *after* lock has been picked). A staircase leads to area 38 and a fireplace rests in the northwest corner. The door in the north wall features a stained glass panel of a man (Tristen) clenching a white feather in a mailed fist; his other hand holds bagpipes, and beneath the window are the words "The Young Minstrel." The representation isn't perfect, so PCs won't recognize Tristen from the window. The door in the east wall is locked.

**B:** The face of the minstrel depicted in the stained glass in the north door has been smashed out. A second door has been added in the west wall, leading to area 4. The original door in that wall has been bricked over.

## VII: WITHIN CASTLE TRISTENOIRA

**C:** The floor is filthy with mud and the staircase is rotten and weak (20% chance per person on them that the steps will collapse). The north wall has been smashed out, and only one half of the door frame remains, a few shards of stained glass hanging from it. Double doors have been added to the south wall, which lead to the drawbridge. The door in the east wall has been smashed open and hangs from one hinge.

### 6. Weapons Room (A, B, C)

**A/B:** This room holds racks of weapons. Swords, spears, maces, crossbows, long bows, and quivers filled with arrows and bolts are found here. A spiral staircase at the center of the room leads up to area 39 and down to area 147. The heavy door in the west wall is locked.

**C:** Rotten racks, once used to hold weapons, sag from the walls. A few broken weapons are scattered across the floor. The door has been smashed open and hangs from one hinge.

### 7. Cloak Room (A, B, C)

**A:** Fine woolen cloaks and shawls hang on pegs. The marble floor is freshly mopped.

**B:** The pegs are empty and the marble floor is cracked and muddy.

**C:** This room has been used as a place to put the rubble from the walls that were demolished in neighboring rooms. Broken stone and plaster fill the room to a depth of 3 feet.

### 8. Sitting Room (A, B, C)

**A:** A large fireplace with a beautifully carved mantle takes up the northwest corner of this room. The mantle depicts running wolves. The room is filled with thick rugs and overstuffed chairs. The door in the south wall features a stained glass panel (see area 5[A]).

**B:** The furniture is dusty and worn. Partially burned pieces of a wooden table can be found in the fireplace. A few smashed wooden chairs lie on the floor nearby. The wolves' heads in the mantle have been hacked off. The stained glass in the south door has been broken (see area 5[B]).

**C:** The south wall has been smashed out, as has part of the west wall near the fireplace. The room is empty and the floor is thick with mud. The mantle has almost fallen off the wall; one end of it lies on the ground.

### 9. Entrance Hall (A, B, C)

**A:** The door leading to the courtyard is of heavy wood, its outer surface carved in a relief showing a mailed fist clenching a feather. This door is locked and barred from the inside. The floor of the room is of black slate.

**B:** At some time during this time period, Andrew ApFittle, the last of his family, will be put to death with a volley of arrows as he stands against the outside of this door. His arrow-studded corpse then will hang there for the rest of this time period.

**C:** The east wall has been smashed out and the floor is thick with mud. The outer door has fallen from its hinges and lies on top of a skeletal corpse. The door's carved panel is studded with arrows—the shafts have broken off, but the points remain in the wood, which is stained red with rust from the arrowheads.

### 10. Kitchen (A, B, C)

**A:** One wall of this room is dominated by a huge red-brick oven. The room is filled with heavy wooden tables upon which sit pots, pans, and other cooking utensils. Shelves hold jars of flour and seasonings. A staircase leads up to area 40. Under the steps is a heavy wooden door leading outside, which is locked and barred from the inside.

**B/C:** Double doors have been added in the north wall. The kitchen is no longer in use, however. The tables have all been stacked against the west wall.

### 11. Pantry (A, B, C)

**A:** This cross-shaped room is filled with sacks of grain, crates of fruit, baskets of vegetables, and a multitude of other foodstuffs. A spiral staircase at the center of the room leads up to area 44 and down to area 150.



## VII: WITHIN CASTLE TRISTENOIRA

**B:** This room contains only a few old crates and moldy baskets, stacked in an untidy heap against the east wall.

**C:** The tower has collapsed. Only a pile of rubble lies where it once stood. The door leading to room 10 has fallen away, exposing the debris, which blocks any view outside and spills into area 10.

### 12. Entryway (B, C)

**B:** Wide arches in the north and south walls give entrance to this sheltered entryway. A cobblestone road, rutted from the passage of carriages, leads through it. Low wide steps lead up to two locked, heavy wooden doors in the east wall. The ceiling is painted in a mural depicting a knight whose face is hidden by his visor, surveying a battlefield on which a multitude of bloody corpses lie. The knight tramples a banner on which is the heraldic charge of a stag rampant (the ApFittle family crest).

**C:** A section of the ceiling has fallen in—the rest looks like it might collapse at any moment. The south door on the east wall has been forced open. The metal bar used to accomplish this lies on the broken step beside it.

### 13. Dining Hall (B, C)

**B:** This area is dominated by an ornately carved wooden table that is 8 feet wide and 60 feet long. One end of the table is dusty, but the other is set with pewter plates and cups that contain the leavings of a recent meal. Broken glass goblets lie underfoot and the hardwood floor is badly scuffed and littered. Four candelabras suspended from the ceiling cast eerie shadows. Paired stairways lead up into darkness, to area 46. Leaded-glass windows in the west wall are cracked, and several pieces of glass have popped from the latticework.

**C:** Broken windows have been boarded shut from inside. The stairs look rotten and have shifted away from the wall. The candelabras crashed down onto the table long ago.



## VII: WITHIN CASTLE TRISTENOIRA

### 14. Water Closet (B, C)

This small room serves as a washroom. Finished with marble, it features a shelf with a ceramic bowl and pitcher for washing up.

### 15. Main Kitchen (B, C)

**B:** A large red-brick oven dominates one wall, and torches provide illumination. The room contains rough wooden tables on which sit heavy cast-iron cooking pots and other utensils. Haunches of meat, surrounded by buzzing flies, hang from hooks in the ceiling. The tables are sticky with spilled wine and flour and the floor is littered with vegetable peelings. A staircase leads up to area 47. A secret door at the base of the stairs leads to area 18.

**C:** The room is no longer in use. Tables have been knocked over, part of the brick oven has collapsed, and the stairs look rotten and have several holes in them (50% chance per person on them that they will collapse).

### 16. Servant's Bedroom (B, C)

**B:** This area is furnished with two cots, a wardrobe, and tables and chairs. The room is lit by an oil lamp. Rumpled blankets on the cots and clothes in the wardrobe indicate that it is occupied.

**C:** A fire in this room demolished the furniture it once held. Blackened pieces of wood lie underfoot, and the walls are thick with soot. A charred human skeleton (burned to death when earth tremors caused a lamp to drop on the bed) lies in one corner.

### 17. Servant's Bedroom (B, C)

**B:** This room is furnished with only one cot, but is otherwise the same as area 16(B).

**C:** The furniture has been smashed to build a small fire on the floor (burned out) and the oil lamp that once lit this room is dented and useless. Soot blackens the walls and the floor is covered with litter and mud.

### 18. Hallway (B, C)

This ordinary hallway is lit by oil lamps. A heavy door in the south wall, leading beyond to

the courtyard, is locked. A secret door in the east wall leads to area 15. Stairs lead up to area 53.

### 19. Carpentry Workshop (B, C)

**B:** This area is filled with pieces of rough-cut lumber, buckets of nails, and work benches. It is brightly lit by hanging oil lamps. Dirty shavings lie underfoot and carpentry tools hang from pegs on the walls. Half-finished projects clutter the room; most seem to be pieces of scaffolding or wooden braces, intended to support sagging walls.

**C:** The room is no longer in use. The wood it once held was burned as fuel long ago. On the muddy floor can be found rusted metal heads from such tools as hammers, chisels, planes, and hand axes. A bucket in one corner holds nails rusted into a solid mass.

### 20. Masonry Workshop (B, C)

**B:** This room is filled with blocks of stone of various sizes, and a layer of stone dust covers everything. It is brightly lit by hanging oil lamps. Stonecutting tools hang from pegs on the walls and a fire crackles in the fireplace. A half-finished statue of a man dressed in a kilt and leaning on a sword occupies the center of the room. The torso is nearly finished, but the head has only been roughed in. The base is also unfinished, but an inscription has been started; the letters "M-A" can be seen.

**C:** This room is no longer in use. The statue has been completed (and now stands in area 37), the tools are gone, and only small pieces of rough stone litter the floor.

### 21. Secret Passage (B, C)

Secret doors in this 15-foot-long tunnel connect area 19 with area 22.

### 22. Stables (B, C)

**B:** This long, narrow area contains six stalls along the north wall. A secret door at the rear of the eastern stall leads to area 21. Two pairs of double doors open to the courtyard, where a



## VII: WITHIN CASTLE TRISTENOIRA

cobblestone road leads through the entryway to the Grand Hall and out of the castle through area 29. The stalls contain fresh hay and water, and they house several mangy horses. An ornate black carriage, thick with dust and cobwebs, occupies the west end of the room.

**C:** The stalls are unoccupied and the hay has long since rotted away. Masonry fallen from the castle walls has torn a hole through the ceiling and crushed part of the carriage. The skeleton of a horse lies under the broken stones in the west stall.

### 23. Passageway (B, C)

**B:** This narrow tunnel connects two spiral staircases leading up to areas 59 (north spiral) and 92 (south spiral).

**C:** A secret trap door in the floor has been added. It provides access to a crude tunnel that leads to area 25.

### 24. Gambling Den (C only)

This room is lit by crude torches and features a strange table whose top holds a series of rough niches. Inside these depressions are colored marbles and small toys. (The goblins use these for gambling chips.) A three-legged stool sits behind the table and crude symbols (wagers) are chalked onto the wall. The rear wall of the room is filled with poorly made metal cages that look large enough to hold a small child. The locks on some of the cage doors are broken, and others have bars that look as if they were gnawed by sharp teeth. The goblins keep gremishkas in these cages.

### 25. Pit Room (C only)

Tristen's goblin minions hold gremishka fights in a shallow, round pit surrounded by a low fence of wrought iron, fashioned in the shape of a twisted black roses. The floor of the pit has several dark stains (gremishka blood). A secret trap door under the dirt provides access to a crude tunnel that leads to area 23. Torches illuminate the room. A rickety-looking stairway leads up to area 60.

### 26. Passageway (B, C)

**B:** This 30-foot-long tunnel connects two heavy portcullises, forming a secondary entrance to the castle grounds. The ceiling overhead is dotted with *murder holes*—thin openings through which arrows can be fired or boiling oil can be poured. A trap door in the ceiling—barred from the other side—leads to area 62; castle defenders can drop through it to finish off those trapped between the portcullises.

**C:** The portcullises have been bricked over from the inside, and the trap door has fallen from its hinges.

### 27. Smithy (C only)

This torch-lit room is dominated by a forge on the west wall, flanked by a large dunking tank. The room is filled with blacksmith's tools. Several half-finished pieces of wrought iron lay on the floor. The work is crude in the extreme and breaks if handled. Most of the works seem to be tools of torture. A staircase on the east wall leads up to area 63.

### 28. Passageway (B, C)

This tunnel connects a spiral staircase, leading up to area 62, with the defensive tower that overlooks the barbican (area 29). It is divided into two sections by a wall with a secret door.

### 29. Old Castle Entrance (B, C)

**B:** This round room features two heavy portcullises. The view through the southwest portcullis is of a road that eventually winds its way down a rolling hill toward Birnam.

**C:** The portcullises have been bricked over from the inside.

### 30. Passageway (B, C)

This tunnel connects area 29 with a spiral staircase leading up to area 68.

### 31. Goblin Chief's Room (C only)

This area features a pile of rags in one corner (a goblin bed never used, since they need no sleep) and a few sticks of broken furniture.

## VII: WITHIN CASTLE TRISTENOIRA

### 32. Goblyn Dining Hall (C only)

This room is filled with buzzing flies and the decaying corpses of animals and humans. It is lit by smoking candles. Among the bones on the floor can be discerned two cracked human skulls. Close inspection indicates that the facial bones have been gnawed by sharp teeth. Windows in the west wall (oddly shaped holes covered by tattered cloth) let in dim light. A rickety-looking wooden ladder leads up through a hole in the ceiling.

### 33. Goblyn Chief's Room (C only)

Same as 31, except for one locked door and one unlocked door in the east wall.

### 34. Morholt's Tomb (A, B, C)

This building is made of white marble and has a rounded stone roof. Inside is a stone sarcophagus, unadorned except for the words "Morholt ApBlanc, 1815–1833." Morholt's corpse lies inside, interred in his armor. In Castle B the body is partially decomposed and reveals his gaping stomach wound while in Castle C he is skeletal.

The ceiling is painted with a mural of a handsome, muscular boy in his late teens. Floating over the boy's right shoulder is a tiny woman holding two spears.

### 35. Gilan's Tomb (A, B, C)

This building is made of white marble and has a rounded stone roof. Inside is a stone sarcophagus, unadorned except for the words "Gilan ApBlanc, 1814–1826." All that remained of Gilan after the wolf attack—a few gnawed bones—has been placed inside. Careful observers (Int check) will find one bone that clearly doesn't match the others—it is the jawbone of Gilan's dog Petitcrieu.

The ceiling is painted with a mural of a angelic-looking blond boy about 12 years of age. An animal stands beside him, but the mural has flaked away, leaving only its paws. A secret trap door in the floor of the tomb leads to area 155.

### 36. Isolt's Tomb (B, C)

This building is made of white marble and has a rounded stone roof. Inside is a stone sarcophagus, unadorned except for the words "Isolt ApBlanc, my beloved bride, 1793–1839." Isolt's corpse lies inside, a withered husk with blackened lips. The ceiling is painted with a mural of a dark-haired woman in her late 40s.

### 37. Courtyard (B, C)

**B:** This area seems to have been carefully tended in the past, but it has now fallen into neglect. There are no trees, except for the sacred oak, which stands between the main entrance to the Lord's Tower and the road of Castle B. A stone watering trough lies against the north wall, outside of area 17.

**C:** The courtyard now is badly overgrown with weeds. The horse trough, now empty and crumbling, still lies against the north wall.

Facing the tombs stands the statue of Tristen dressed in a kilt and leaning on a sword. The base is inscribed "Lord Marc ApBlanc." This was the half-finished statue of area 20(B).

### 38. Armor Display Room (A, B, C)

**A:** The walls are hung with shields, and a suit of armor stands against the east wall. Near it are bases and stands for two more suits of armor, but the suits themselves are gone. A staircase leads down to area 5, and the heavy door in the southeast wall is locked.

**B/C:** Everything is covered in dust except for the suit of armor, which is brightly polished.

### 39. Weapon Repair Room (A, B, C)

**A/B:** Broken weapons of various types lie on rough work tables in this room, awaiting repair. Shelves on the walls hold various tools. A spiral staircase at the center of the room leads up to area 70 and down to area 6, but the way up is closed off by a heavy, locked door. The door in the west wall is locked.

**C:** This room contains overturned work tables and broken, rusted weapons.



## VIII: WITHIN CASTLE TRISTENOIRA

### 40. Dining Hall (A, B, C)

**A:** Set in front of the fireplace is a long, polished table ringed with carved chairs. A locked sideboard is stocked with wine and spirits. A staircase leads down to area 10, and large windows in the west wall let in lots of light. Two candelabras hang over the table.

**B:** The room is dusty and unused. Several of the windows have cracked, and bottles have spilled out of the sideboard.

**C:** The windows are missing entirely and the bottles have been hurled against the fireplace and smashed.

### 41. Wine Storage (A, B, C)

**A:** This room is filled with racks of fine wine. The door leading into the room is locked.

**B:** Most of the bottles in the niches have been surreptitiously drunk by Tristen's servants, then refilled with water, recorked, and put back.

**C:** That this was once a wine storage room is clear from the racks that line its walls. The floor is littered with broken bottles.

### 42. Store Room (A, B, C)

**A:** The shelves that line the walls of this room are filled with plates, goblets, cutlery, linen, candlesticks—all of the things necessary to set the table in the dining hall.

**B:** The earth tremors have spilled everything from the shelves into a heap on the floor.

**C:** The heap has been picked over. It contains only a few rotten linens, broken goblets, and cracked plates.

### 43. Water Closet (A, B, C)

This small room serves as a washroom. Finished with gray slate, it features a shelf with a ceramic bowl and pitcher for washing up.

### 44. Laundry/Scullery (A, B, C)

**A:** Steaming buckets of sudsy water, stacks of dishes, and piles of dirty linen reveal that this room is used as a combination laundry and scullery. A spiral staircase at the center of the room leads up to area 75 and down to area 11.

**B:** Because the kitchen and dining hall of the Lord's Tower have not been in use for some time, this room is now used as a tub room where Tristen's mercenaries wash. Some of the large tubs hold a scum of water in the bottom, and some have dirty towels draped over them.

**C:** This is now a pile of debris. The door to this area is missing and the remains of the tower block the portal.

### 45. Rooftop (B, C)

**B:** This flat rooftop of the entryway to the grand hall is surrounded by a low wall and lined with benches, and it serves as a patio. Ceramic pots once held flowers, but now they are choked with weeds.

**C:** Portions of the floor have given away. Those areas still intact appear ready to collapse (and will if two or more characters stand within 5 feet of each other—2d6 points of falling damage).

### 46. Grand Hall (B, C)

**B:** The floor of this room is ornately finished in black and white tile; on each black tile is etched a white feather. A railing near the east wall separates twin staircases that descend to area 13, and a small staircase against the south wall leads up to area 76.

Stained glass windows line the west wall. Each window commemorates the agonizing death of a member of the ApFittle family, and each victim's first name appears on a brass plaque on the window sill. From south to north, the windows depict: Mary, her head crushed by a mace; John, fallen from a sword fight on a tower; Stuart, drowning in a river; Angus, dragged by a horse; Aethel, run through by a lance; Lizzy, savaged by wolves; and Patrick, impaled on spikes. The northernmost window contains clear glass. This final window will commemorate the death of Andrew ApFittle, currently held in the dungeons (area 148). See area 9(B) for details of his death.

Several of the windows have cracked, and pieces have popped from them. Two large

## VII: WITHIN CASTLE TRISTENOIRA

murals on either side of the main staircase depict two of the lord's "four freedoms." The one to the north is inscribed with the words "Freedom to Want," and shows peasants in rags looking over a blighted crop. The one to the south is inscribed with the words "Freedom from the Gods," and shows priests being tortured and executed.

**C:** Only fragments of each of the windows remain, the railing near the east wall is missing, and the murals are chipped and dirty. The northernmost window has been replaced with stained glass; it depicts the death of Andrew ApFittle, who is pierced by dozens of arrows.

### 47. Pantry (B, C)

**B:** This room is filled with sacks of grain, crates of fruit, baskets of vegetables, and other foodstuffs. The staircase leads down to area 15.

**C:** The foodstuffs are rotten, and the stairs look rotten and have several holes in them.

### 48. Warming Room (B, C)

**B:** A small brick oven built into the wall keeps this room warm. Lining the walls are tables laid with various trays and platters. Oil lamps, hanging from the ceiling, illuminate the room. This is obviously a room where food is warmed prior to being served in the great hall. Secret doors in the wall beside the oven lead to area 54.

**C:** The room is no longer in use. Tables are overturned and the serving trays are gone.

### 49. Wine Storage (B, C)

**B:** This room is filled with fine wines of various vintages; the bottles are stored in racks on the walls. Several of the bottles contain poison disguised as wine (Type J—see the *DMG*); Tristen uses them to poison his enemies. Roll percentile dice for each bottle taken by a PC. On a roll of 10% or less, the bottle is poisoned.

**C:** That this was once a wine storage room is evident from the racks that line its walls. The floor is littered with broken bottles.

### 50. Servants' Bedroom (B, C)

**B:** This room is simply furnished with two cots, a wardrobe, and wooden chairs. Rumpled blankets and dirty clothes on the cot, and empty ale bottles on the floor indicate that it is occupied. An oil lamp hangs from the ceiling, illuminating the room.

**C:** The furniture has been smashed and moldy feathers from slashed pillows cover everything. A human head—that of the corpse in 51(C)—is inside one of the pillows.

### 51. Servants' Bedroom (B, C)

**B:** The same as area 50(B), except that several pieces of furniture have been overturned. A full bottle of ale sits in one corner.

**C:** The furniture has been smashed, and the walls are smeared with dark misshapen hand prints (goblins wiped blood off their hands here years ago). A headless human corpse, dead for several years, lies at the center of the room. The head is in area 50(C).

### 52. Store Room (B, C)

**B:** Bolts of cloth were once neatly stacked on the shelves that line this room, but they now have tumbled onto the floor. Several have been torn into strips for use as bandages by Tristen's mercenaries. Bloody pieces of cloth are scattered on the floor.

**C:** The cloth is rotten and infested with bugs.

### 53. Hallway (B, C)

**B:** A railing surrounds three sides of a staircase that leads down to area 18. The stairs are littered with empty ale bottles.

**C:** The railing is gone and the stairs are rotten (10% chance per person on them to collapse).

### 54. Store Room (B, C)

**B:** Bottles of ale once were stored neatly on shelves, but they now have spilled onto the floor. Several have shattered while others, judging by the multitude of footprints on the sticky, dusty floor, have been carted away.

**C:** The floor is littered with broken bottle glass.



## VII: WITHIN CASTLE TRISTENOIRA

### 55. Seamstresses' Workshop (B, C)

**B:** This room is filled with looms, spinning wheels, cutting tables, shoe molds, and leather craftsman's tools. Bolts of cloth stand against one wall. Work here stopped some time ago and a layer of dust coats everything. Tartans hang half-woven on the looms, and most of the equipment has been pushed to the sides of the room. Three rough cots with rumbled bedding have been placed near the fireplace. The room is lit with oil lamps. A secret door, hidden behind bolts of cloth, leads to area 58.

**C:** Much of the equipment has been smashed and what remains of the cloth is rotted.

### 56. Ale and Wine Maker's Workshop (B, C)

**B:** This room is filled with large barrels, casks, presses, gallon jugs, and empty wine and ale bottles. The sweet smell of fermenting grain, apples, and grapes hangs in the air, and coals glow in the fireplace. Work has been interrupted here, however, and several of the barrels and

casks have been opened before the ale or wine making process was complete. The floor is sticky with the resulting spillage, and flies buzz lazily in the air. The room is lit with oil lamps. A small table off to one side contains the equipment and ingredients for adding poison to select vintages.

**C:** No trace of ale or wine remains. Several of the barrels have been smashed and used as firewood, and the grape press has been used for a grimmer purpose . . . as the crushed skeletal remains inside it attests.

### 57. Stable Rooftop (B, C)

**B:** The rounded rooftop of the stables is 30 feet below the castle walls. The roof is finished with curved clay tiles.

**C:** A large portion of the westernmost end of the rooftop has collapsed, and the rest looks shaky. There is a 25% chance that anyone who climbs on this roof will fall through it (1d6 points of damage).

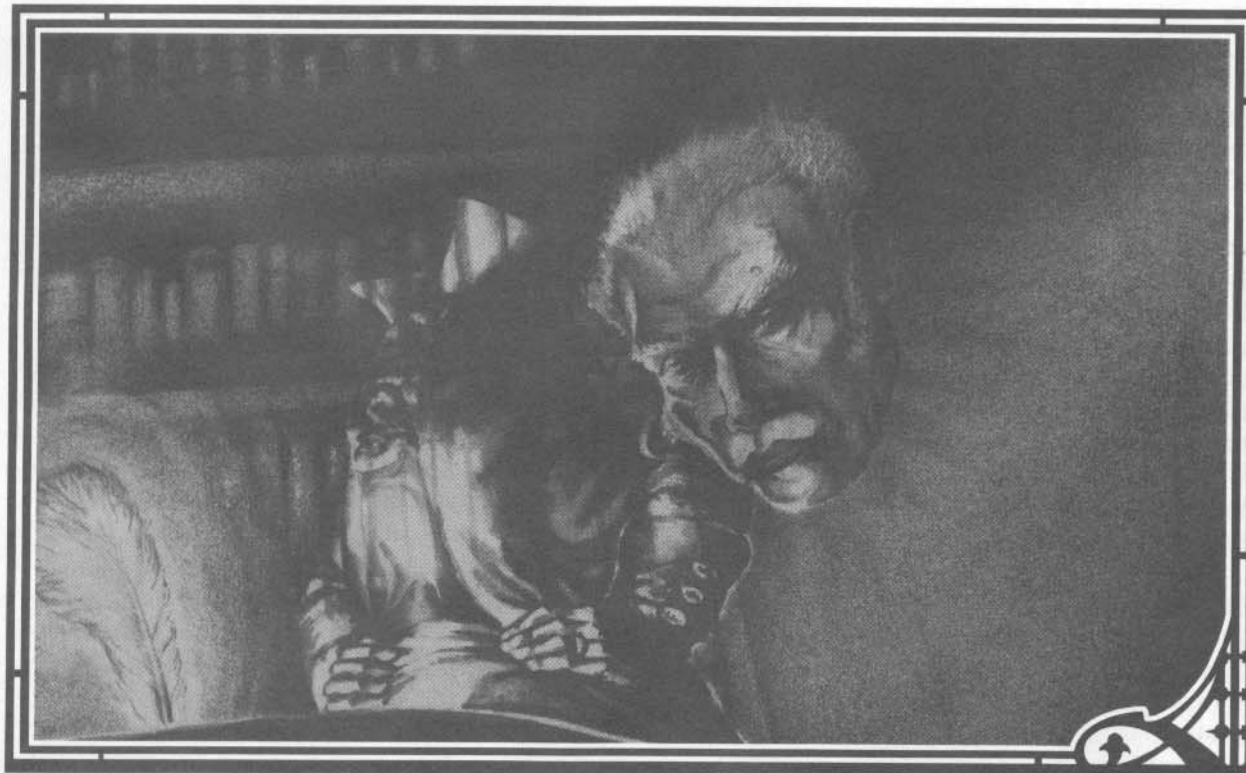

## VII: WITHIN CASTLE TRISTENOIRA

### 58. Passageway (B, C)

Secret doors at both ends of this tunnel connect area 55 with area 59.

### 59. Passageway (B, C)

This dead-end tunnel contains a spiral staircase leading up to area 91 and down to area 23.

### 60. Goblin Brewery (C only)

This room is filled with rough-looking clay pots in which a sour-smelling mess is fermenting. This is goblin ale, made from fermented pine needles and rotten fruit. The concoction has a vile taste, but it's heavily intoxicating. Portions of the thatch roof have fallen in.

### 61. Viewing Loft (C only)

A flimsy wooden balcony fences off a hole in the floor that overlooks the gremishka fighting pit on the floor below. Boxes and buckets have been overturned for use as seats. Stairs lead down to area 25.

### 62. Passageway (B, C)

**B:** This passageway has two legs: a 70-foot-long tunnel leading from north to south and an 85-foot-long tunnel leading from northwest to southeast. The former leg has a trap door in the floor that is barred shut from this side, leading to area 26, and a number of *murder holes* in the floor—thin openings through which arrows can be fired or through which boiling oil can be poured. At the bend, a spiral staircase climbs to area 92 and descends to area 28. There also is a locked door, leading to area 64, at the south end of the corridor.

**C:** The trap door has fallen from its hinges into the passage below, and most of the murder holes are plugged with dirt.

### 63. Loft (C only)

In this loft hangs a poorly constructed *iron maiden* and a number of pieces of wrought iron scrap. Inside the iron maiden are the misshapen skeletal remains of a goblin. A staircase on the east wall leads to area 27.

### 64. Portcullis Machinery (B, C)

**B:** This round room contains the machinery used to raise and lower the portcullises below it. It is filled with heavy wooden winches, chains, and stout ropes.

**C:** The mechanisms are no longer in use. The room has obviously been used at some point in the past as a prison chamber; skeletal human corpses are manacled to the wall.

### 65. Hallway (C only)

This U-shaped hallway has a number of arrow slits in its walls. A secret door leads to area 68.

### 66. Hallway (C only)

This second U-shaped hallway is joined to the first by doors and to the ground floor by a rickety ladder that descends through a hole in the floor. A secret door leads to area 67.

### 67. Treasure Room (C only)

This secret room is used by the goblins to store their treasure. In it are placed several of the smaller items of treasure, taken from their victims, which their lord allows them to keep. A secret door leads to area 66.

### 68. Passageway (B, C)

This tunnel connects a spiral staircase leading up to area 94 and down to area 30 with a door leading to the Lord's Tower. In Castle C, a secret door in the north wall at the west end of the tunnel leads to area 68.

### 69. Guard's Mess Hall (A, B, C)

**A:** This room contains a number of low tables and three-legged stools. Pewter plates and mugs are laid out on the tables. A staircase, overlooked by two windows, leads down to area 38. The windows are of leaded glass, and each respectively contains an inscription: "Death cannot dissuade us" on the east pane and "We sing the praises of the minstrel ApBlanc" on the west window.

**B:** The room shows a number of signs of wear. The tables have been carved with a number of



## VII: WITHIN CASTLE TRISTENOIRA

initials and crude inscriptions, the floor is dirty, and the windows are cracked and pieces are missing. The inscriptions now read: "Death cannot dissuade . . ." and ". . . ApBlanc." A secret door on the west wall, near the fireplace, leads to area 95.

**C:** The stairs are falling apart and the room is filthy. Only one word of the window inscriptions remains: "Death . . ."

### 70. Duelling Room (A, B, C)

**A:** This room is used for fencing practice, which is evident by the foils and masks on the walls. A number of pieces of sword-scarred furniture have been placed in this room as obstacles. The floor bears the ominous red stain of spilled blood. A spiral staircase at the center of this room leads up to area 98 and down to area 39, but the way down has been closed off by a heavy, locked door. Barred windows in the turrets let in natural light.

**B:** Glass hangs in shards in the windows, and the door in the west wall hangs open. The foils and masks are rusty and covered with dust.

**C:** The door has fallen from its hinges and one of the turrets has fallen away, leaving a gaping hole in the east wall that reveals a long vista from atop the 1,000-foot-high cliff upon which Castle Tristenoira sits.

### 71. Guest Bedroom (A, B, C)

**A:** This room is furnished with a bed, wardrobe, night table, chest, and writing desk. A circular throw rug is on the floor. The room is clean, but not currently in use.

**B:** The necromancer Lucy ApMorten now sleeps here. Her bedclothes are rumpled and the wardrobe is filled with black dresses and robes. Several animal skeletons, the bones carefully bleached and mounted, adorn the room like trophies.

**C:** The room has been ransacked by Tristen. The mounted skeletons are smashed and the black dresses and robes have been slashed with a dagger and left in a heap on the floor. They now are moldy and rotten.

### 72. Game Room (A, B, C)

**A/B:** This room is filled with a number of well known parlour games. A table, flanked by overstuffed arm chairs, holds a large chessboard while shelves hold numerous other games as well as various decks of playing cards. There is a bearskin rug on the floor.

**C:** This room is clean and still in use. The door, however, has been fitted with a lock. This is one of the few rooms that Tristen still bothers to maintain. The table is laid with a half-finished game of solitaire and the chess board is also set up in a partially played game. (The black player is close to check-mate.) The powerful chess pieces look like people who bear horrified expressions. The black king looks like the ghostly Tristen and the queen like the ghostly Isolt. The two black knights look like the ghostly Morholt and Gilan. The pawns are goblins and wolves, while the bishops are tortured druids. The rooks are evil treants. The white side looks like the living counterparts.



## VIII: WITHIN CASTLE TRISTENOIRA

### 73. Guest Bedroom (A, B, C)

The door to this room is nailed shut (a successful open doors roll is required to open it). Inside, it is much like area 71(A), except the bedclothes have been stripped and the lumpy mattress has a huge red stain. Everything is thick with dust. This is the room in which Morholt died by his father's hand. It has been sealed ever since that fateful morning.

### 74. Hallway (A, B, C)

The door in the north wall of this hallway exists in time periods B and C only. The hallway is ordinary in all regards.

### 75. Studio (A, B, C)

**A:** This area contains several easels, stools, and couches. On the tables are various mortars and pestles, jars of pigment, blank canvasses that have been mounted on frames, brushes, and pallets. There are two partially finished canvasses: one of a pale-looking woman in her mid-40s (Isolt) and one of a handsome man in his mid-20s, (Tristen). The faces and shoulders of these are complete, but the rest of the painting is only blocked out. A spiral staircase leads up to area 103 and down to area 44.

**B:** The room is still intact, but a layer of dust covers everything and the paints in the jars have dried out. The half-finished paintings (now complete and hanging in area 89) are gone.

**C:** The tower has collapsed. The door to this room remains upon its hinges, but it will fall off if anyone opens it. The debris outside just reaches this level.

### 76. Hallway (B, C)

**B:** Steps at the south end of this area lead down to area 46. The north door is locked. It is an ordinary hallway.

**C:** The hallway is littered with broken plates, and butcher's knives are stuck into the floor. The goblins have been playing games here, rolling plates down the hall and throwing butcher's knives at each others' feet.

### 77. Store Room (B, C)

**B:** The walls of this room are lined with shelves that contain plates, glasses, cutlery, and serving trays. Several of these items have spilled onto the floor, due to the earth tremors in this "Time of Terrors."

**C:** The plates have been removed and the glasses smashed. Goblins have taken several of the large metal serving trays to use as shields and breastplates.

### 78. Water Closet (B, C)

This small room serves as a washroom. Finished with pink marble, it features basic facilities, including a shelf with a ceramic bowl and pitcher for washing up.

### 79. Audience Chamber (B, C)

**B:** In this opulent room, a large, ornately carved wooden chair is set on a dais below two large, leaded windows. The rest of the floor is covered by a plush carpet—the design on it is of a mailed fist clutching a white feather. Trophy shields line the walls. The leaded windows are finished with diamond-shaped panels of red and white. A large mural on the west wall depicts one of the lord's "four freedoms." It is inscribed with the words "Freedom to Speak," and the magnificent mural shows members of the nobility lined up before a chopping block, awaiting execution.

**C:** Several panels in the windows have popped out, the carpet is threadbare and dirty, and the mural is chipped. The ornate chair has a dagger sticking out of its backrest. (An overbold adventurer tried to stab the ghostly Tristen as he sat here one night. The dagger passed right through the lord, embedding itself in the wooden chair.)

### 80. Store Room (B, C)

**B:** This room contains the linens, tablecloths, and wall hangings used in the grand hall.

**C:** The cloth is rotten and moldy, and part of the ceiling has fallen in, effectively obliterating the door.



## III: WITHIN CASTLE TRISTENOIRA

### 81. Accounting Room (B, C)

**B:** This room is furnished with a wide desk and a stool. Its walls are lined with shelves, on which the account books of the castle sit. Several have spilled onto the floor, and an ink well is overturned on the desk, sending a black stain across the papers on it.

**C:** The papers are brittle and the books worm-eaten. Several of the account books have been pulled from the shelves and trampled underfoot, and part of the ceiling has fallen in, obliterating the door.

### 82. Waiting Room (B, C)

**B:** This room contains several overstuffed couches, low tables, and a large throw rug. A large mural on the west wall depicts one of the lord's "four freedoms." It is inscribed with the words "Freedom to Fear," and shows members of the nobility running in terror from a knight. This room is where visitors would wait for an audience with the lord in area 79.

**C:** The couches are torn and moldy, the rug is threadbare, and the mural is chipped and dirty.

### 83. Map Room (B, C)

**B:** The door to this room is locked. Inside are several long tables piled with rolled-up maps. Beside them are unlit oil lamps. Other maps have been fixed to the walls. Detailed maps show Forfar and the village of Birnam. More general maps show the lands that neighbor Forfar. A new, vellum map in the process of being drawn has been pegged out on a table. It documents the changes that are taking place in the land during this "Time of Terror."

**C:** Most of the maps are brittle or stained with mold. The room is dusty, but the door still locks and the room is intact. The map that was being drawn in 83(B) now is complete and hangs on one wall. On it, Tristen plots the course of his goblyn's forest-clearing projects. There are also several X marks on the map, with the question "Sanctuary?" scribbled beside each. A secret door behind this map provides access to area 86.

### 84. Guest Bedroom (B, C)

This room is furnished with a bed, wardrobe, night table, chest, and armchair. There is a fur rug on the floor. The room is clean, but not in use. PCs will be offered this room if they wish to stay in Castle Tristenoira—it is one of the few rooms Tristen maintains.

### 85. Hallway (B, C)

**B:** Stairs in the wider part of this carpeted hallway lead up to area 106. A door in the west wall opens to stairs (area 88) that lead down to the courtyard. The south wall of the hallway features three stained glass windows. These depict wolves howling at a moon, which is in a different phase in each window.

**C:** Portions of the windows have fallen out and the carpet is threadbare and dusty.

### 86. Store Room (B, C)

This room holds bedding and linens for the guests. In winter, it is used as a drying room. Laundered sheets are hung in front of its fireplace to dry.

### 87. Water Closet (B, C)

This small area serves as a washroom. Finished with black marble veined with gold, it features basic facilities, including a shelf with a pewter bowl and pitcher for washing up.

### 88. Stairs (B, C)

These stairs lead down from the third story of the guest tower (area 85) to the courtyard, passing over the roof of the stables.

### 89. The Lord's Bedroom (B, C)

This room is sumptuously furnished with a four-poster bed, an ornately carved wardrobe and chest, a writing desk and chair, and overstuffed arm chairs that are drawn before the fireplace. Fur rugs line the floors and the walls are covered by tapestries. The wardrobe is filled with crisp shirts, neatly pressed kilts, and polished shoes. On the north wall hang two portraits, one of a man in his mid-20s (Tristen), holding bagpipes,

## VII: WITHIN CASTLE TRISTENOIRA

the other of a woman in her mid-40s (Isolt), with a strained smile. These portraits were half-finished in Room 75(A). This is the room Tristen will pretend to retire to each night if he is entertaining visitors in either of these time periods.

### 90. Guest Bedroom (B, C)

This is much the same as area 84, except that this room has a fireplace.

### 91. Passageway (B, C)

**B:** This tunnel connects the guest tower with a spiral staircase that leads up to area 111 and down to area 59.

**C:** There is a gaping hole in the ceiling and the south wall.

### 92. Passageway (B, C)

This tunnel connects two spiral staircases leading up to area 111 and down to areas 23 (north spiral) and 62 (south spiral). The tunnel

stretches 55 feet to the southeast of the south spiral before coming to a dead end in a pile of rubble. The sky can be seen through holes in the collapsed ceiling at this point.

### 93. Necromancer's Laboratory (B, C)

**B:** The door to this round room is securely locked. This room is a wizard's laboratory. A desiccated corpse is strapped to a table at the center of the room. Benches around the edges of the room are lined with beakers, sealed jars, weighing scales, and glass tubes. Tiny wire mesh cages hold a number of tiny creatures (rats, bugs, crows—many of them missing limbs or eyes) and there are several large metal pots and oil burners for mixing and heating ingredients. Shelves hold bones of every description. Several of the items have tumbled to the ground, due to the earth tremors. This lab belongs to the necromancer Lucy ApMorten, whom Tristen hired in an effort to bring Isolt back to life.





## III: WITHIN CASTLE TRISTENOIRA

**C:** Tristen has killed Lucy and destroyed the lab in an insane frenzy because Lucy's attempts to revive Isolt have proven futile. All of the lab equipment has been broken and smashed. The walls have strangely colored stains where jars of magical ingredients were hurled at them, and the table holding the corpse (now skeletal) has been overturned. Thick dust covers everything, and a foul, chemical smell lingers in the air.

### 94. Passageway (B, C)

This tunnel connects area 93 to spiral stairs leading up to area 111 and down to area 68.

### 95. Passageway (B, C)

This passageway has secret doors at both ends.

### 96—1, 2, 3, 4. Rooftops (C only)

**C:** These roofs are all made of thatch. The work is sloppy, and some of the thatching has slid off or collapsed. The rooftops have steep slopes, and the peaks are 15 feet lower than the castle walls. A chimney rises out of 96-3.

### 97. Sitting Room (A, B, C)

**A:** This room is filled with overstuffed armchairs and foot stools. A staircase on the south wall leads down to area 69.

**B:** A door has been added in the west wall, leading to the castle wall. The armchairs have been replaced with rough tables and benches, and cloaks hang on pegs on the walls.

**C:** The door on the east wall now hangs open. Charcoal from the fireplace has been used to draw simplistic images of skulls and dying humanoids on the walls.

### 98. Dance Hall (A, B, C)

**A:** The walls are painted with bright murals showing kilted dancers leaping over crossed swords, their arms raised above their heads. The floor of this room is of polished hardwood. A spiral staircase at the center of the room leads up to area 125 and down to area 70; the way up, however, has been blocked off by a locked door (-20% to lock-picking attempts).

**B:** The hardwood floor of this room is badly scuffed. Now present are racks of weapons, barrels of oil, stacks of torches, and heavy cauldrons. Faded murals on the wall suggest this was once a dance hall.

**C:** Decrepit and broken weapons litter the floor of this room. The walls, once painted with bright murals of dancers, have been defaced. Black lines (drawn with charcoal) have been drawn on each of the dancers, turning their heads into grinning skulls. The defacement also includes crude drawings of spears and arrows piercing the bodies of the dancers. The goblins have turned this into a place for worshipping Arawn, evil god of death and the underworld.

### 99. Brangain's Room (A, B, C)

**A:** The door to this room is securely locked (-20% to lock-picking attempts). Inside is a four-poster bed, a wardrobe with a gilt-framed mirror, a wash-stand, an overstuffed arm chair, and a desk upon which sits a mortar and pestle and small pouches of herbs. Inside the wardrobe hang white shirts and long dark dresses. The bed is neatly made, but the drawers in the wardrobe have been pulled out and their contents spilled onto the floor. (Isolt has been searching for clues to her daughter's disappearance.) The room appears to be occupied. Its walls are painted with a mural showing a woodland scene.

**B/C:** A thick layer of dust covers everything and the room is thick with cobwebs. The mural has been deliberately chipped off the wall—it lies in chunks on the floor.

### 100. Gilan's Room (A, B, C)

The door to this room is securely locked (-20% to lock-picking attempts). Inside are a child's bed, a chest, a play table and chairs, and a small wardrobe. Plates crusted with the remains of a meal sit on the table. On the floor beside the table is a silver dog dish, also crusted with old food. Everything is covered with a thick layer of dust, and although the wardrobe is filled with the clothes of a boy of about 12, it is also choked

## VII: WITHIN CASTLE TRISTENOIRA

with cobwebs. The walls of this room are painted in a mural depicting dogs of every description. All of the dogs are rendered in natural colors except one representing Petitcrieu, a multicolored terrier who wears a golden bell around his neck.

### 101. Water Closet (A, B, C)

This area serves as a washroom. It is painted in bright colors and features basic facilities, including a shelf with a ceramic bowl and a pitcher in the shape of a dog, for washing up.

### 102. Morholt's Bedroom (A, B, C)

The door of this room is securely locked (~20% to lock-picking attempts). Inside is a four-poster bed, a wardrobe, a weapons rack on the wall (holding two rusty spears and a bow), a table, and two chairs. There is a long, dark stain on the rug beside the bed, as if a bloody weapon had lain there. The bedclothes are rumpled and the table and chairs overturned as if someone had left the room in a great hurry.

### 103. Playroom (A, B, C)

**A:** This area is filled with brightly colored blocks, rocking horses, wooden swords and shields, kilted dolls, and other childhood toys. A thick layer of dust covers everything. A spiral staircase at the center of the room leads up to area 121 and down to area 75.

**B:** The toys have been shoved to one side.

**C:** The tower has collapsed and lies in a pile of debris as high as the next level down.

### 104. Rooftop (B, C)

**B:** This steeply pitched roof is covered with gray slate tiles that are very slippery in any kind of wet weather. Only a 1-foot-high rail prevents those who would cross the roof from falling to the ground, about 50 feet below.

**C: Rooftop.** A portion of the rooftop has fallen in and several of the tiles are loose and sloughing off. While the drop on the west side is still 50 feet to the courtyard, the drop on the east side now includes the 1,000-foot height of the cliff on

which the castle is perched. There's a 60% chance that the foot-high railing will snap if anyone uses it to keep from falling off the roof. If a PC slides into it after slipping and falling from the roof's peak, the chance of it breaking off rises to 90%.

### 105. Captain of the Guard's Bedroom (B, C)

**B:** This room contains a bed, locked chest, wardrobe, and wash stand. A sword and shield hang on a weapon rack against the north wall. A brass telescope rests on a bench that is set underneath two windows on the south wall. The room is lit by an oil lamp.

**C:** One of the goblyn clan chiefs now occupies this room. The furniture is relatively intact, but the bedding is filthy and the contents of the wardrobe are scattered amongst goblyn litter that covers the floor. The telescope, having been used by the goblyn as a club, is now twisted and bent. The sword and shield are still in place, but both pieces are crusted with dried blood and rust.

### 106. Hallway (B, C)

**B:** The north staircase in this hallway leads up to area 114, while the south one leads down to area 85. The floor is carpeted and the area is lit by oil lamps on the walls. A stained glass window on the south wall depicts a knight holding his own severed head, from which the eyes have been gouged. Under the knight is the inscription, "Mercy is blind."

**C:** The carpet is threadbare and the stained glass window is mostly gone. All that remains of the knight is his hand, holding his head. A fragment of the inscription also remains, reading simply, "Mercy . . ."

### 107. Pantry (B, C)

This room is filled with sacks of grain, crates of fruit, baskets of vegetables, and a multitude of other foodstuffs. Garlic, fashioned into a wreath, hangs on the outside of the door of this room. This is the one pantry that is still in use and is relatively clean in time period C.



## III: WITHIN CASTLE TRISTENOIRA

### 108. Kitchen (B, C)

One wall of this room is dominated by a red-brick oven. The room is filled with heavy wooden tables on which sit pots, pans, and other cooking utensils. Several shelves hold jars of flour and numerous jars of spices. This is the one kitchen that is still in use and is relatively clean in time period C.

### 109. Guard's Sitting Room (B, C)

**B:** This room features a wide fireplace, several rough benches and tables, and a few three-legged stools. Several cloaks hang from pegs on the walls. The room is lit by oil lamps. The door in the east wall is locked.

**C:** Some of the furniture is now broken. The floor is filthy and strewn with gnawed bones.

### 110. Weapons Room (B, C)

**B:** This room holds racks of weapons. Swords, spears, maces, crossbows, long bows, and quivers filled with arrows and bolts can all be found here. The tables hold fletcher's tools and other weapons-maintenance devices. The doors in the south and west walls are very securely locked (-40% to lock-picking attempts).

**C:** The weapons are all of poor manufacture and are not very well maintained. Most of them are rusty, dirty, or broken.

### 111. Castle Walls (B, C)

**B:** A 10-foot-wide walkway runs around the top of the castle walls. The outside edge features a chest-high crenelated wall. The inside edge is protected by an iron railing. Four round battlements can be found at bends in the walls; a larger tower (area 112) is situated at the southwest bend. Trap doors in each of the battlements give access to spiral stairways leading down to areas (from north to south) 91, 92, 92, and 94. Each trap door can be barred shut from this side. A section of the southwest arm's floor has already fallen in, due to the earth tremors in this "Time of Terrors."

**C:** The walls are cracked and crumbling. In two places, sections of the wall have crumbled away,

and one of the battlements has lost part of its crenelation and appears ready to collapse at any time. On the north wall, the iron railing that prevents defenders from accidentally falling into the courtyard is rusted and bent, and a section of the floor is fallen in.

### 112. Archer's Post (B, C)

Access to this round room is via two doors leading to the castle walls (area 111). Either door may be barred from inside this room, preventing attackers from progressing along the walls. The south half of this room features a number of arrow slits. Bows and quivers of arrows hang from racks on the north wall.

### 113. Guest Room (B, C)

**B:** This room is furnished with an unmade bed, wardrobe, night table, armchair, and writing desk. A fur rug lies on the floor. The room is dusty, but with a little cleaning it would be ready for use. A door in the northwest corner provides access to a spiral staircase leading up to area 118.

**C:** A large portion of the ceiling has fallen into the room. The furniture in it is now wet and moldy.

### 114. Hallway (B, C)

**B:** A staircase, surrounded on three sides by a wooden railing, leads down to area 106. At either end of this carpeted hallway are round bays, and each has been set with crescent-shaped benches illuminated by two stained glass windows. Each window depicts a death caused by one of the four elements. The windows on the north wall depict a person falling from a high tower in "Death by Air," and a person drowning in "Death by Water." The windows in the south wall depict a person burned at the stake in "Death by Fire," and a person buried alive in "Death by Earth."

**C:** Most of the panels in each of the windows have popped out, and the carpet is wet and moldy from the rain that has come in through the broken doors in the east wall.

## VII: WITHIN CASTLE TRISTENOIRA

### 115. Guest Bedroom (B, C)

**B:** This room is furnished with an unmade bed, wardrobe, night table, armchair, and writing table. A thick wool rug lies on the floor. The room is dusty, but with a little cleaning it would be ready for use. A door in the northeast corner provides access to a spiral staircase leading up to area 118.

**C:** That a room once existed here is indicated by a hallway door that still hangs from one hinge. The space beyond is a confused heap of stonework, beams, and slate tiles.

### 116. Reading Room (B, C)

**B:** This room contains two overstuffed armchairs, complete with footstools, that rest by the fireplace. The walls are lined with shelves of books. All of the books contain works of fiction, mostly adventure stories and tales of romance. A door in the southwest corner provides access to a spiral staircase leading up to area 118.

**C:** A gaping hole in the ceiling has let water in. The books are now moldy and unreadable.

### 117. Music Room (B, C)

**B:** This room contains a harpsichord, lute, bagpipes, and a rack holding four recorders of various sizes. All instruments are in good repair, but they are dusty and in need of tuning. A door in the southeast corner provides access to a spiral staircase leading up to area 118.

**C:** That a room once existed here is indicated by an empty door frame. The space beyond is a confused heap of stonework, beams, and slate tiles.

### 118. Rooftop (B, C)

**B:** The steeply pitched roof of the guest hall is covered with gray slate tiles that are very slippery in any kind of wet weather. On the east and west sides, only a 1-foot-high rail prevents those trying to cross the roof from falling to the ground, 80 feet below. There is a 60% chance that the foot-high railing will snap if anyone uses it to keep from falling off the

roof. If a PC slides into it after slipping and falling from the roof's peak, the chance rises to 90%. In each corner of the roof is a round turret with a waist-high crenelated wall encircling it. False turrets at the center, below the peak, offer no place to stand. The turrets serve as balconies, providing a view toward the village of Birnam to the northwest and over the castle courtyard and approach to the castle to the south. Access to each turret is through a trap door in the floor.

**C:** The eastern half of the roof has fallen in. The northeastern turret has fallen away completely and the southeastern one clings precariously to the wall, ready to fall at any moment.

### 119. Tristen and Isolt's Bedroom (A, B, C)

**A:** This sumptuous room is laid out around a fireplace, and it is well lit by plain glass windows in the west wall under which are situated upholstered benches. A niche to the east of the fireplace serves as a cloak room while the main part of the room is furnished with a large four-poster bed, two wardrobes, a vanity, arm chairs, and a writing desk. All are of rich dark wood, inlaid and painted with gilt.

**B/C:** The room is no longer in use. Wind blows through broken windows, the carpets are water-stained and moldy, and cobwebs abound.

### 120. Water Closet (A, B, C)

**A:** This small room serves as a washroom. Finished with marble, it features ornate facilities, including a black marble floor and shelf upon which sit an engraved silver bowl and pitcher for washing up.

**B/C:** The bowl and pitcher have been stolen.

### 121. Sewing Room (A, B, C)

**A:** This room contains soft couches, a few low tables, and frames on which half-finished embroideries are stretched. One of them depicts a woman in a woodland setting, removing a thorn from a wolf's paw. A spiral staircase at the center of the room leads up to area 134 and down to area 103.



## VIII: WITHIN CASTLE TRISTENOIRA

**B:** The tapestries have been taken off the frames, rolled up, and shoved into one of the table drawers. The embroidery now is dusted with mold.

**C:** The tower has collapsed. A pile of debris is visible about two levels below, and much of the tower has tumbled down a 1,000-foot cliff just beyond the castle's foundations.

### 122. Private Dining Room (A, B, C)

**A:** This small room contains a table set for two. On it are silver plates and utensils, fine glass goblets, and silver candelabras.

**B/C:** The silverware has been stolen. One plate that was missed lies under the table, and the glass goblets lie broken on the floor, under a thick layer of dust.

### 123. Hallway (A, B, C)

The south door in the east wall is securely locked (-20% to lock-picking attempts).

### 124. Sitting Room (A, B, C)

**A:** This room contains two armchairs and footstools drawn up in front of the fireplace. A thick wool rug, bearing the design of two reclining lovers, covers the floor. A staircase beside the fireplace leads up to area 132.

**B/C:** The rug has been rolled up and shoved to one side, and the staircase appears rickety.

### 125. Music Room (A, B, C)

The door to this room is securely locked (-20% to lock-picking attempts). Inside are many instruments—woodwinds of every description, a harpsichord, bagpipes, drums, an upright harp, and a variety of stringed instruments. The room is clean and well maintained. This is Tristen's private collection, the room is where he comes when he wants to be alone with his music. He allows no one in this room, but melancholy music often drifts out of it during the day. A spiral staircase at the center of the room leads up to area 135 and down to area 98. A floor trap door is securely locked, but it can easily be opened from this side.



## VIII: WITHIN CASTLE TRISTENOIRA

### 126–131. Servant's Quarters (A, B, C)

Each of these tiny rooms contains two cots, a table, and a simple wardrobe. In Castle A they house servants, in Castle B they house mercenaries, and in Castle C they are occasionally used by goblins. The condition of each room deteriorates accordingly. In Castle C, the ceilings over Rooms 126 and 131 have fallen in.

### 132. Hallway (A, B, C)

This area has steps leading down to area 124 and a spiral staircase leading up to area 136.

### 133. Hallway (A, B, C)

This area leads to a small sitting area illuminated by two leaded glass windows.

### 134. Empty Room (A, B, C)

**A/B:** When Tristen married Isolt, he promised her a room that she could furnish as a chapel to her god, but the room remains unfinished. A mural on the wall was never taken further than the first few brush strokes, but the chalk lines on the wall show what was to have been painted: a woman clutching an amulet at her neck, bending over the bed of a sick person. A spiral staircase at the center of the room leads up to area 137 and down to area 121. A door in the east wall leads to a crenelated balcony that encircles the tower. A folded piece of paper containing a small shard of metal lies on the floor. See page 11 of *Eve of Sorrows* for details.

**C:** The tower has collapsed and the door is missing. Debris from the tower can be seen three levels down, but much of the tower has tumbled over a 1,000-foot cliff just beyond it.

### 135. Library (A, B, C)

This room contains a great many books and scrolls, stacked on shelves that encircle this room. Tristen's private library contains a number of rare, valuable works, several of which contain information that might harm Tristen. (These are quite jealously guarded.) The room itself is clean

and contains only a thin layer of dust, and the door is very securely locked (–40% to lock-picking attempts). A spiral staircase at the center of the room leads up to area 138 and down to area 125. There is a ceiling trap door that blocks the way to area 138, locked with an extremely heavy and complex lock (–50% to lock-picking attempts). A locked door in the east wall leads to a crenelated balcony that encircles the tower.

### 136. Rooftop (A, B, C)

**A/B:** The steeply pitched roof is covered with gray slate tiles that are very slippery in any kind of wet weather. On the east side, a 1-foot-high rail prevents those trying to cross the roof from falling to the ground, 95 feet below (9d6 points of damage). There is a 60% chance that the foot-high railing will snap if anyone uses it to keep from falling off the roof. If a PC slides into it after slipping and falling from the roof's peak, the chance rises to 90%.

On the west side are three turrets, each surrounded by a waist-high crenelated wall. These are joined by a walled walkway that is 5 feet wide. The central turret has a trap door in its floor that gives access to a spiral staircase, leading down to area 132.

**C:** The roof now has two gaping holes. The tiles are loose and sloughing off. On the east side, the drop is accentuated by the 1,000-foot cliff on which the castle is perched.

### 137. Sick Room (A, B, C)

**A:** This room is furnished with comfortable beds and warmed by braziers. There are armchairs and footstools in each of the round turrets. Taking up the south wall is a huge cabinet with a number of locked drawers. Each is labeled with a brass plaque. This room is used by Isolt to tend the sick. The cabinet contains a number of medicinal herbs, as well as minerals, animal parts, flowers and oils used in the treatment of illness. A spiral staircase leads down to area 134 and also up to a trap door that opens to area 139.



## VII: WITHIN CASTLE TRISTENOIRA

**B:** The cabinet has been hacked open and its contents scattered across the dusty floor. The windows are broken and the wind howls in.

**C:** The tower has collapsed and the door is gone. Some debris lies in a heap about four levels down, but much of the tower has tumbled down the 1,000-foot cliff upon which the castle is perched.

### 138. Study (A, B, C)

This is Tristen's private study. Most of the papers here are notes about the druids whom he hopes to eliminate from Forlorn and tales of the lands beyond his domain, as recounted to him by the few adventurers who have dared to enter Castle Tristenoira. This room contains a large desk set between the two turrets, as well as two armchairs and a number of cabinets. The desk is stocked with writing paper, inkwells, and quill pens. A spiral staircase at the center of this room leads up to a trap door that opens to area 140 and down to area 135.

### 139. Conservatory (A, B, C)

**A:** This room is well illuminated, thanks to several windows and to skylights in the high roof. The chamber is filled with growing things—flowers and herbs of every description. Isolt grows medicinal plants here. A trap door in the floor lends access to a spiral staircase leading down to area 137.

**B:** Most of the plants have died and weeds choke the planters. The windows are grimy, and some are cracked or broken.

**C:** The tower has collapsed and the door is badly jammed. A PC who forces open the door (open doors roll) should make a Dexterity check with a -4 penalty to avoid losing balance and falling to the rubble some five stories below (5d6+10 damage, due to sharp rocks and other injurious debris).

### 140. Storage (A, B, C)

The windows of this room are tightly shuttered. Inside it are boxes and chests of every shape, size, and kind, and many of them secured with

padlocks. The room also contains a number of household treasures: portraits, pieces of silverware, tapestries, heirlooms, and other mementoes. Gilan's child-sized suit of armor stands amid the clutter. A trap door in the floor (which can be barred shut) provides access to a spiral staircase leading down to area 138.

### 141. Archery Post (C only)

The walls of this room feature a number of slits through which archers can fire upon those approaching the castle. A metal ladder runs up to a trap door in the ceiling, leading to area 1, and a staircase leads down to area 160. The room is of shabby construction and the arrow slits are all different sizes and shapes, most of them not particularly practical.

### 142. Connecting Courtyard (C only)

This courtyard is open to the sky and connects the two archery posts of the barbican.

### 143. Portcullis Mechanism (C only)

This area houses the crudest and most poorly designed mechanism for raising a portcullis ever seen. If used, it is likely to either break or freeze in place.

### 144. Archery Post (C only)

This is the same as are 141, except there is no staircase and the trap door in the ceiling (leading to area 2) has fallen off its hinges.

### 145. Passageway (A, B, C)

**A/B:** This passageway is built in two sections. The east section connects two locked doors, leading from a guard post (area 147) to the torture room (area 146). The west section, connected to the east by a secret door, lends access to a hidden wall with slits for secretly viewing the torture room. At the north end of the west section is a stairway leading down to sub-level 2. The stairs lie behind a locked door.

**C:** A second secret door has been added to this passage, providing access to caverns beneath the castle.

## VII: WITHIN CASTLE TRISTENOIRA

### 146. Torture Room (A, B, C)

This room is filled with implements of torture. In Castle C, Tristen's goblin minions torture the druids in an effort to learn of their plots against the lord and to discover the location of Sanctuary. The door is securely locked (-20% to lock-picking attempts).

### 147. Guard Station (A, B, C)

This room lies at the base of the spiral staircase that runs through the tower (below area 6). It is strictly a resting and waiting area, with two stools and a rough wooden table. The door to area 145 is locked and features a small, barred window at eye level.

### 148. Prison Cells (A, B, C)

**A:** Each of these cells has a barred door and contains stale, vermin-infested straw, a slop bucket, and a musty blanket. The cells generally contain servants who have displeased Tristen, as well as a few villagers whose blood the lord drinks.

**B:** Andrew ApFittle occupies the middle cell. At some point in this time period, he will be taken out and executed in front of Room 9(B).

**C:** The cells contain 1d4 captured druids.

### 149. Hallway (A, B, C)

**A/B:** From this hallway jailors can monitor prisoners in the cells. Rough wooden benches along the east wall provide a place for the keepers to sit. Between the benches is a bucket and a hole in the floor, where prisoners could wash up before being taken up into the castle to face the lord.

**C:** The collapse of the tower to the east has opened a 6-inch-wide crack in the east wall. The fissure crosses the floor of 149 and branches, sending veins into the northernmost three cells. Water seeps through the cracks in the floor and puddles in the cells.

### 150. Well Room (A, B, C)

**A/B:** This room lies at the base of the spiral staircase that leads up to area 11. It contains a

well that is the main supply of drinking water for the castle. Several buckets and a spare winch-rope hang from pegs on the walls.

**C:** The tower has fallen, filling this area with impenetrable rubble.

### 151. Cavern (C only)

When the Forlorn was physically wrenched from the Prime Material Plane and thrust into Ravenloft, these caverns (and area 154) were formed. This cavern, connected to area 145 by a short tunnel, has walls of rough stone. In the far west end are stacked corpses of tortured and murdered druids. The cavern has a fairly flat floor and is a mere 10 feet high. It narrows at one point to a gap no more than 2 feet wide.

### 152. False Treasury (C only)

The door to this area is very securely locked (-40% to lock-picking attempts). Inside are several locked chests that contain coins, gems, and other wealth, but not a great amount (see page 25 of *Eve of Sorrows*). They are intended to be a diversion.

### 153. Hallway (C only)

With a secret door to area 151, this hallway joins areas 151, 152, and 154.

### 154. Cavern (C only)

The walls of this 40-foot-deep cavern are of rough stone. Fresh water trickles from a crack in the south wall, forming a puddle on the floor that seeps out through another crack. A rickety looking metal ladder next to the door leads down to the bottom of the cavern and sublevel 2. There is a secret door in the northwest corner of the cavern, leading to area 165, and another secret door in the southeast corner of the room, leading to area 169.

### 155. Trapped Hallway (A, B, C)

A trap door can plainly be seen in the ceiling, which leads to area 35. The corridor's walls are smooth and metallic. This hallway is packed with traps that protect Tristen's own sanctuary.



## VII: WITHIN CASTLE TRISTENOIRA

First, any person or object passing through the hallway—even flying—causes the walls to arc with lightning for 4d6 points of damage per 5 feet traveled (save vs. rod for half damage). Next, the floor is trapped with barbed spears that thrust upward in response to any pressure on the floor, suspending impaled victims. Each 5-foot-square releases 2d4 spears in a random pattern when walked upon; PCs must make a successful Dexterity check for each spear that emerges or suffer 2d6 points of damage. Finally, there is Type E poison gas (see the *DMG*) inside the mechanism of the locked door that fills the first 10 feet of the corridor as soon as the door is touched. (Roll for initiative, including for the poison [give the poison a +4 bonus]—those who move after the poison's "initiative" are caught in the cloud.)

### 156. Tristen's Sanctuary (A, B, C)

This is one of the resting places in which Tristen sleeps on the four days of the year during which he becomes mortal. The door to this area is sealed with a 10th-level *wizard lock* spell. (The password is "Rivalin.")

The room itself is simply furnished with a sumptuous four-poster bed. The plush carpet that covers the floor around the bed is trapped with hollow glass needles containing a deadly Type F poison. These needles are almost impossible to spot (–50% to find traps attempts—removing the traps is impossible).

### 157. Hallway (A, B, C)

A trap door that leads down to area 169 can clearly be seen in the floor of this short hallway. The other end of the hallway ends in a featureless black door without a handle. Like area 155, this hallway contains deadly traps that protect Tristen's second sanctuary.

First, anyone passing through the corridor—even flying—will cause black flames to erupt from the floor, walls, and ceiling. These ice-cold flames fill the hallway, inflicting 3d4 points of damage, and drain 1d4 points of Strength per 5 feet of passage traversed (save vs. paralysis for

half damage and no Strength loss; lost Strength will return at the rate of 1 point per day). Next, the locked door at the end of the hallway is trapped. Anyone touching any part of this black metal door—even with another object—and who fails to successfully save vs. spell (with a –4 penalty) will suffer waking nightmares for the next 1d6 hours. During this time, the character is affected as if a horror check has been failed.

### 158. Sanctuary (A, B, C)

This area is sealed with a 10th-level *wizard lock* spell (the password is "Flora"). The room itself is filled with so many sticky spider webs that they act like a *web* spell. These webs, however, cannot be burned, and they are smeared with Type N contact poison. Tristen knows a safe path through the webs, and he moves through them by using either a *potion of gaseous form* or *oil of slipperiness*.

### 159. Weapons Room (C only)

This room contains racks of unusual and ineffective-looking weapons made by the goblins. Most are poorly constructed and are liable to break or inflict only minimal damage.

### 160. Hallway (C only)

Uneven steps—each of a different height and width—lead up to area 141.

### 161. Entry to the Castle (C only)

Two portcullises block off access to the road outside the castle and to the sloping approach to the castle. Both are raised perhaps 4 feet off the ground.

### 162. Guard Post (C only)

This room is filled with makeshift barriers, made out of old barrels, planks and broken bits of stone. The goblins, unable to remember how to lower the portcullises, defend the castle approach from these positions. Six goblins are positioned here when the PCs attempt to enter the castle grounds.

## VII: WITHIN CASTLE TRISTENOIRA

### 163. Treasury (A, B, C)

This room is Tristen's real treasury. It contains the wealth he has plundered from his victims over the years, as well as a store of magical items (see page 25 of *Eve of Sorrows*). It is protected by two extremely securely locked doors (-60% to lock-picking attempts).

### 164. Hallway (A, B, C)

This is the original approach to the treasury. It is protected by a series of irregularly spaced pit traps that are hidden by illusionary walls. Two of them (T1 and T4) are 30 feet deep and are lined with sharp blades that shred a victim for 3d6 points of damage, plus another 3d6 points of falling damage. T5 is filled to a depth of 10 feet with acid that inflicts 3d4 damage while the victim is in the pit and 1d4 damage for the next ten rounds, unless the victim is doused with at least three gallons of water. T2 and T3 are 20-foot-deep pits; a heavy, wedge-shaped block of stone falls from the ceiling when a victim falls into the pit, sealing it and the hallway with a plug that reaches to the ceiling (blocking passage). Victims who fall in suffer 2d6 falling damage and have 1d6 rounds of oxygen in the cramped space below the rock, which requires a combined Strength of 80 to lift.

### 165. Hallway (C only)

This area contains a stone plug trap identical to T2 and T3 in area 164. A secret door in the south wall leads to area 154 and an extremely securely locked door (-60% to lock-picking attempts) in the north wall leads to area 163.

### 166. Prison Cells (A, B, C)

These cells are identical to those in area 148, except that these have solid wooden doors with barred windows that can be shuttered from the outside to eliminate all light from the cells. In the time period of Castle A, Brangain is locked inside the north cell. She has scratched her name into the wall and some brief details of her imprisonment. She will escape at some point during this time period.

### 167. Hallway (A, B, C)

This narrow hallway has a flight of stairs that leads up to area 145.

### 168. Study (C only)

This room is where Tristen whiles away his time when in hiding from hunters and other troublesome visitors to the castle. The elegantly furnished room is lit by oil lamps and contains armchairs, a desk, a table, and a wardrobe. Paintings and tapestries hang on the walls, and a fur rug helps keep the stone floor warm. Shelves lining one wall are filled with books. There is a secret door, leading to area 170, in the southeast corner of the room.

### 169. Hallway (C only)

A secret trap door in the southeastern ceiling of this hallway leads up to area 157. By climbing up on the door to area 171, the ceiling trap can be reached.

### 170. Pantry (C only)

This small room is filled with boxes of preserved food and bottles of fine wine. Its shelves also contain silver plates, fine glass goblets, utensils, serving trays, and linens for the dining table. There is a secret door leading to area 171 in the southeast corner of the room, and another leading to area 168 in the southwest corner.

### 171. Trophy Room (C only)

**C:** The walls of this room are lined with stuffed heads of hideous beasts. Strange pelts cover the floor. Armchairs made of bone, horn, and scratchy hide occupy the corners. There also are a pair of human skeletons dressed in the plain brown kilts of the druids. A secret door in the west wall leads to area 170 while the room may be entered normally from area 169.



CLIMATE/TERRAIN:	Special
FREQUENCY:	Unique
ORGANIZATION:	Solitary
ACTIVITY CYCLE:	Any
DIET:	Special
INTELLIGENCE:	Very (11-12)
TREASURE:	B
ALIGNMENT:	Chaotic evil
NO. APPEARING:	1
ARMOR CLASS:	-3
MOVEMENT:	12 (Sw)
HIT DICE:	13
THACO:	7
NO. OF ATTACKS:	1
DAMAGE/ATTACK:	3d8
SPECIAL ATTACKS:	Breath weapon, spells
SPECIAL DEFENSES:	+1 or better weapon needed to hit; <i>fear</i>
MAGIC RESISTANCE:	20%
SIZE:	G (100')
MORALE:	16 (Champion)
XP VALUE:	11,000

Aggie is a unique creature, found only in Forlorn. She is an ancient, gargantuan, undead water serpent with grayish-green skin and a huge mouth lined with needle-sharp teeth. Her scaly hide is reminiscent of the skin of a zombie, rotten-smelling and marked with rents and gaps through which pale white bones show. When swimming on the surface, she often appears to be a head followed by a series of rounded humps.

**Combat:** Aggie never leaves the lake, but she will attack any creature that comes close to its shore. She lures the curious and foolhardy into range by appearing briefly in the center of the lake, then disappearing under water, only to appear moments later within striking range of the shore. Despite her undead state, Aggie is extremely supple, and she can twist and curve her long body around, moving quickly through the water. She can coil her body underwater and strike like a snake up to 50 feet from the edge of the lake or up to 60 feet above the surface of the water.

Aggie bites for 3d8 points of damage. On any bite that inflicts 8 or more points, Aggie locks her jaws around the victim and pulls him or her down into her underwater lair. To break free, the victim must make a successful Strength check. Otherwise, Aggie holds the victim underwater until drowning results.

Aggie can exhale a highly toxic cloud of sickly yellow vapor, 40 feet long and 20 feet wide and high, three times per day, producing same effect as that of the 5th-level wizard spell *cloudkill*. Aggie's breath lingers in the air, moving slowly along with the breeze and sinking into depressions, for four rounds before dissipating.

Should the battle turn against Aggie, she can innately invoke the effects of the 4th-level wizard

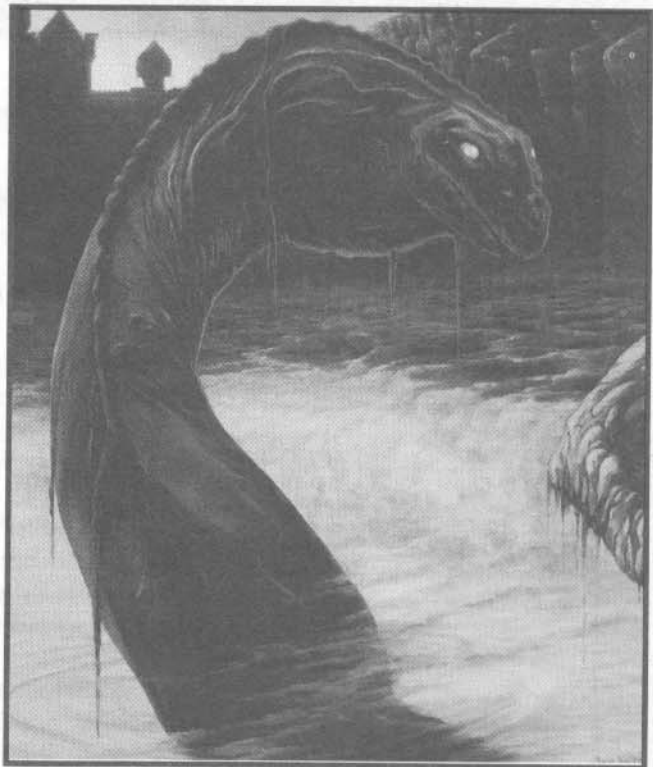

spell *fear* (three times per day). This affects all creatures within 100 feet who do not make a successful fear check.

Because Aggie is an undead creature, she may be turned (as a 10-HD creature). Due to Aggie's magical nature, a +1 or better weapon is required to hit her.

**Habitat/Society:** Aggie is a unique creature, yet there are some who speculate that there is more than one "serpent of the depths," saying they have sighted two separate sets of humps breaking the surface of the Lake of Red Tears at once. Some maintain that Aggie has a brood of little serpents, and that her attacks on any who approach the lake are the equivalent of a mother protecting her young. But it is unclear how an undead creature could give birth to young.

Aggie's watery lair is said to be filled with the treasures of those she has pulled down to their depths, but the lake has a depth of hundreds of feet, so it's unlikely that any of Aggie's treasure will ever be recovered. Even if items are, any armor or weapons in the horde (unless magically protected) are likely to be rusted and useless.

**Ecology:** Because she is undead, Aggie has no natural life span. If killed, Aggie will not provide any useful products. Her hide is tough enough to use for (leather) armor or a shield, but it has an oppressive stench that will force a character trying to use it to make hourly saving throws vs. poison to avoid nausea (-1 penalty to attack rolls).

CLIMATE/TERRAIN:	Temperate/any
FREQUENCY:	Rare
ORGANIZATION:	Special
ACTIVITY CYCLE:	Any
DIET:	Special
INTELLIGENCE:	Semi (2)
TREASURE:	Special
ALIGNMENT:	Neutral evil
NO. APPEARING:	Special
ARMOR CLASS:	10 (trunk); 7 (branches/heads)
MOVEMENT:	Nil (tree)/Fl 6(E) (heads)
HIT DICE:	10 (plus 6 hit points per head)
THACO	11
NO. OF ATTACKS:	1 per head
DAMAGE/ATTACK:	1 hp per seed (per head) or 1d4 per bite (per head)
SPECIAL ATTACKS	Seed spitting
SPECIAL DEFENSES:	Immune to fire
MAGIC RESISTANCE:	10%
SIZE:	H (15'-20' tall)
MORALE:	Fearless (20)
XP VALUE:	1,400

A death's head tree looks much like a 15- to 20-foot-tall weeping willow, excepts its branches are thicker. Its seeds need blood to germinate, so it grows most commonly in places where a great deal of blood has been spilled; battlefields and places of sacrifice are two areas where death's head trees thrive. In fact, these trees often mark places where ancient battles have been fought or where evil temples once stood.

A mature tree bears a strange and terrible fruit: 4d4 rotten-smelling "death's heads." Each of these appears to be a severed head of any of the standard human and demihuman races, except for the fact that each head grows from a branch of the tree and is attached to the branch at the neck. In time, these heads ripen and "fall" from the tree, actually floating away on organic gases, seeking the bodies of warm-blooded creatures in which to plant their seeds.

**Combat:** Like most carnivorous plants, the death's head tree engages in combat primarily when potential victims come within its reach, but this plant has a unique lure: It grows heads that are distinctly humanoid in appearance and then, with its very limited intelligence, animates them just enough to enable the heads to softly call "help." While those who investigate the source of the pleas have few problems identifying the heads as monstrous, curiosity or repugnance (and a resulting urge to destroy the tree) frequently draws them in close enough for the tree to attack.

When physically attacked, the death's head tree uses its "fruit" to defend itself. Each head is capable of biting once per melee round, inflicting 1d4 points of damage and simultaneously inserting a seed into the wound (see below for the effects of harboring a

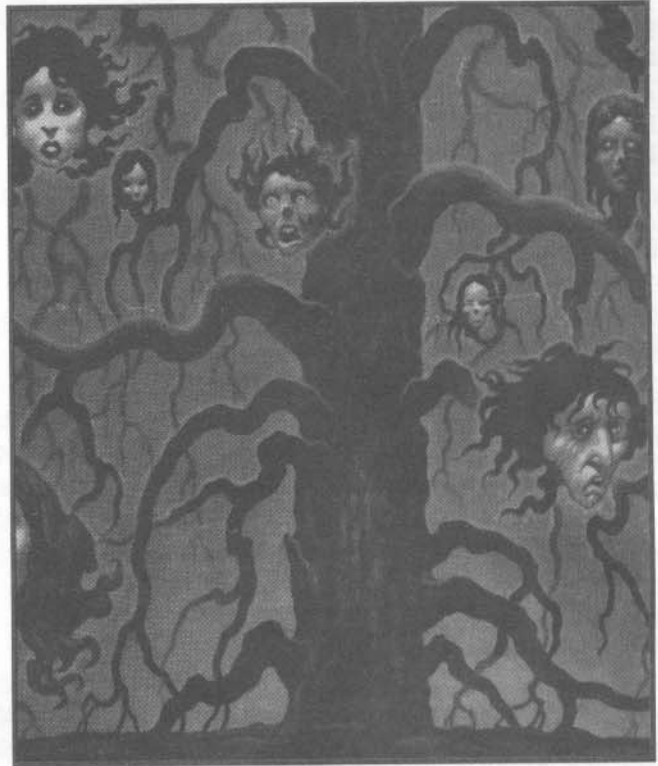

death's head seed). While the death's head tree itself is not capable of locomotion, it can move its branches. Hence, the trunk has an Armor Class of 10, but the branches and heads have an effective Armor Class of 7. Due to this mobility and the flexibility of its branches, the tree is capable of making as many attacks against a target as it has death's heads. Each head will die upon sustaining 6 points of damage, and the branches may be hacked off upon sustaining 10 points of damage (from a slashing weapon only).

Each of the 4d4 death's heads on a mature tree contains 1d6 needle-sharp seeds that inflict minimal damage (just 1 point of damage per seed) upon a successful hit. The heads are capable of spitting these (one seed per head per melee round) at any warm-blooded creature who ventures within 30 feet of the tree.

The seeds may be removed within 24 hours, in much the same way as one would remove a splinter (inflicting another point of damage in the process). However, the points of the seeds excrete a low-grade, natural anesthetic, which means that they don't bother the victim after the initial sting of penetration. Therefore, many victims forget about them after the battle is over, allowing the seeds to take root. If left in place for longer than a day, the seeds germinate and begin to grow, causing an ever-increasing amount of damage as sprouts spread through the victim's body. The shoots inflict 1d4 points of damage on day one, 2d4 damage on day two, 3d4 damage on day three, and so on, to a maximum of 10d4 points of damage per day.



Forcibly removing or cutting these new shoots out of a victim's body, once they have rooted, inflicts damage equal to half of what would otherwise be the growth damage for that day, and doing so has only a 50% chance to be completely effective. A slip of the plant may remain inside the victim's body and continue to grow. Any spell that will kill a plant, however, will immediately kill the growths (which at this stage have no immunity to magic or fire).

While most carnivorous plant life is largely anchored to a single spot, the fruit of the death's head tree becomes fully mobile, once it has ripened and broken from the branch. Buoyed by gases produced by their own rot, the fallen heads float off, seeking a warm-blooded creature in which to plant their seeds. The smell of blood can attract a death's head from as far away as a mile, and it can travel up to 20 miles in search of a warm-blooded host. Once a potential victim is located, the death's head spits until all of its 1d6 seeds are gone. Once its seeds are exhausted, it will continue to attack by biting for 2d4 rounds, at which point it falls to the ground, dead.

Although the fruit of a death's head tree has the appearance of a waxy, slack-jawed corpse, a head is not considered undead as long as it is still attached to the tree. Only when it has fully matured and broken from the tree does it assume the characteristics of undead. At this point, it can be turned as a zombie. Once fallen from the tree, the head is also vulnerable to fire, but it retains its magic resistance.

**Habitat/Society:** There is only one limit to the number of death's head trees that can grow in a given area, and that is how much blood has been spilled. Theoretically, there could be one tree for every corpse. In fact, it is not uncommon to see an entire forest of tiny saplings springing up a few days after a large battle. Of course, until these reach maturity, they can be killed or uprooted as easily as any other plant. Also, they tend to sink their roots into each other, attempting to steal extra life's blood and grow stronger, and eventually only one tree is left within 50 or more feet. Thus, the fully mature death's head tree is a rare find.

**Ecology:** The average death's head tree takes 50+1d10 years to mature to the point where it can grow a crop of death's heads. Until the time when its branches thicken enough to bear the weight of its ghastly fruit, it looks much like a weeping willow. Only a knowledgeable observer can tell the difference.

Once it reaches maturity, a death's head tree is capable of living for thousands of years. A few sages have speculated that cutting down a specimen and counting its rings can establish the number of years that have passed since a battle was fought or a place of sacrifice was abandoned. The theory is a sound one, but few people who are aware of the tree's nature will volunteer to chop one down and prove it.

Once a death's head tree matures, it produces a crop of death's heads every other year. Within 1d6 days of budding, the death's heads grow from the size of walnuts to the size of normal humanoid heads. Having reached their full size, they take on a distinctive appearance (and foul odor) and then begin to softly call out the word "help" in a language appropriate to the race of the head. Within another 3d6 days, they ripen and begin to fall.

Aside from its need for blood to germinate its seeds, the death's head tree takes its daily sustenance from the sun and soil like any other plant. It does not require any more blood to survive, once it has successfully germinated and rooted itself in the ground. Because there is no limit to the type of terrain on which blood is spilled, the death's head tree grows virtually anywhere. One may be found growing among the stones of a ruined temple or on an ancient battlefield that is littered with rusted weapons and the bleached bones of the soldiers who once fought there.

Since the fruit of a death's head tree is always humanoid in appearance, it is largely believed that the seeds can be germinated only in humanoid blood. A few experiments attempting to sprout a seed in animal blood have thus far been unsuccessful, but sages theorize that this should be possible, since the death's heads are known to spit their seeds at warm-blooded animals, as well as humanoids.

Some say that the fruit of a death's head tree resembles the face of he or she whose blood nurtured it. Indeed, since the death's head fruit has been heard to whisper in many languages, some sages believe that each is an undead manifestation of a particular individual. Others insist that this is no more than mere mimicry, that there is no connection between those who have died and the fruit of a death's head tree.

Due to its magical nature, a mature death's head tree has a limited amount of magical resistance. It is also immune to fire and fire-based magical attacks. The wood of a mature death's head tree is prized for its natural magical resistance and immunity to fire, and it is an essential part of many magical devices, especially fire-resistant shields. It is also used as a component in fire-protection spells.

While a death's head tree has no treasure of its own, those it kills often carry treasure. There is a 15% chance that a corpse lies at the foot of a death's head tree. If so, it will have Treasure Type U, plus 1d10 of each type of coin. The body also will (90% of the time) have a death's head tree sapling growing out of it.

CLIMATE/TERRAIN:	Any
FREQUENCY:	Very rare
ORGANIZATION:	Nil
ACTIVITY CYCLE:	Any
DIET:	Nil
INTELLIGENCE:	Non (0)
TREASURE:	Nil
ALIGNMENT:	Neutral evil
NO. APPEARING:	2d4
ARMOR CLASS:	6
MOVEMENT:	9
HIT DICE:	2+2
THACO:	19
NO. OF ATTACKS:	1
DAMAGE/ATTACK:	1d4+1
SPECIAL ATTACKS:	Nil
SPECIAL DEFENSES:	See below
MAGIC RESISTANCE:	Nil
SIZE:	S (2'-4')
MORALE:	Special
XP VALUE:	120

Zombie wolves are not created by a wizard or a priest, but are a creation of the domain of Forlorn itself. Because a zombie wolf looks exactly as it did in death, these creatures often have gaping wounds and sometimes are even missing a limb. They have dirty, matted fur and a rotten stench that is noticeable up to 100 feet away.

A zombie wolf cannot howl like its living counterparts, but it does occasionally throw back its head and utter a strangled cry from rotting vocal chords (prompting a horror check the first time it is heard). These creatures move with a stiff-legged gait at half the speed of a living wolf.

**Combat:** Like all zombies, the slower speed of the zombie wolf means that it strikes last in any combat round (it automatically loses the initiative). While they can be turned and destroyed by priests, zombie wolves otherwise fight mindlessly until their intended target is dead or they are destroyed. They will break off their attack only if called off by the lord of the domain.

Zombie wolves have an Armor Class that is slightly better than that of regular wolves, due to the toughness of their dead, leathery skin. They attack by biting, just as living wolves do, inflicting 1d4 + 1 points of damage upon a successful hit.

Like other undead, zombie wolves are immune to *charm*, *hold*, and *sleep* spells, as well as death magic, poison, and cold-based spells. Holy water can also damage them, inflicting 2d4 points of damage when it strikes them. They are turned as zombies, except when they are acting under the direct control or orders of the lord of Forlorn, at which time they impose a -2 penalty upon a priest's attempt to turn them.



**Habitat/Society:** Zombie wolves are usually found within a few miles of the spot where they were killed (and rose again to unlife). Like living wolves, they tend to form packs, but these are much smaller than normal, with no more than eight members. Under special circumstances, such as an assemblage called together by the lord, the pack can contain virtually every zombie wolf in the domain. It takes 1d6 hours for a pack of this size to accumulate, and anyone who sees the mass of monsters gathering is easily subject to both fear and horror checks, even if the pack hasn't yet mobilized or chosen the viewer as its prey.

**Ecology:** Zombie wolves rise from the dead when the body of any regular wolf in the domain of Forlorn is not decapitated after it is killed. If this gruesome task is not carried out, the corpse of the wolf rises as a zombie 2d8 days after it has died.

It is generally thought that the creatures gain this strange form of existence from contact with the land itself, which channels energy from the Negative Material Plane. Some sages speculate that simply preventing the wolf carcass from having any contact with the ground for a full eight days will prevent it from rising as a zombie, but in the absence of any practical application of this theory, it remains unproven.





1088XXX1901

ADVANCED DUNGEONS & DRAGONS, AD&D, and RAVENLOFT are registered trademarks owned by TSR, Inc.  
The TSR logo is a trademark owned by TSR, Inc. ©1993 TSR, Inc. All Rights Reserved. Printed in the U.S.A.

# Ravenloft®

Boxed Adventure Set



## Eve of Sorrows

Mysteries Book





# EVE OF SORROWS

## Table of Contents

<b>Introduction</b> .....	2	<b>NPCs and Monsters</b> .....	18
What's Needed to Play .....	2	Castle A: The Lord's Tower .....	18
Organization .....	2	Castle B: Castle ApBlanc .....	19
<b>Temporal Shifting</b> .....	3	Castle C: Castle Tristenoira .....	23
The Flow of Time .....	4	Encounters in	
Entering and Leaving the Castle .....	4	Multiple Time Periods .....	24
Separating the Party .....	5	<b>Clues and Treasure</b> .....	25
Same Lord, Different Period .....	5	Treasures of Castle Tristenoira .....	25
Temporal Paradoxes .....	5	Mysterious Missives .....	26
Defeating the Lord .....	7	<b>Special Encounters</b> .....	29
<b>Major Hauntings</b> .....	8	Death of an Ancestor .....	29
Tristen ApBlanc .....	8	Unholy Night .....	29
Rual .....	9	A Dire Warning .....	32
Isolt ApBlanc .....	10	<b>Other Important Entries:</b>	
Gilan ApBlanc .....	11	Temporal Shift Table .....	3
Morholt ApBlanc .....	11	Andrew ApFittle	
Flora ApBlanc .....	12	(game statistics) .....	21
<b>Minor Hauntings</b> .....	14	Lucy ApMorten	
Geists .....	14	(game statistics) .....	22
Haunts .....	16		

## Credits

**Designer:** Lisa Smedman  
**Editor:** David Wise  
**Project Coordinator:** Dori Jean Watry  
**Graphics Coordinator:** Sarah Feggstad  
**Art Coordinator:** Peggy Cooper  
**Box Cover Artist:** Dana M. Knutson  
**Poster Artist:** Robh Ruppel  
**Booklet Cover Artist:** Stephen Fabian  
**Interior Artists:** Stephen Fabian, Arnie Swekel, and Robert Klasnich  
**Typography:** Angelika Lokotz  
**Cartography:** David C. Sutherland III and Cynthia Felegy

ADVANCED DUNGEONS & DRAGONS, AD&D, and RAVENLOFT are registered trademarks owned by TSR, Inc. MONSTROUS COMPENDIUM, DUNGEON MASTER, DM, and the TSR logo are trademarks owned by TSR, Inc. All characters, character names, and the distinctive likenesses thereof are trademarks owned by TSR, Inc. ©1993 TSR, Inc. All Rights Reserved.

Random House and its affiliate companies have worldwide distribution rights in the book trade for English-language products of TSR, Inc. Distributed to the toy and hobby trade by regional distributors. Distributed to the book and hobby trade in the United Kingdom by TSR Ltd. This material is protected under the copyright laws of the United States of America. Any reproduction or unauthorized use of the material contained herein is prohibited without the express written consent of TSR, Inc.

TSR, Inc.  
POB 756  
Lake Geneva  
WI 53147  
U.S.A.



TSR Ltd.  
120 Church End  
Cherry Hinton  
Cambridge CB1 3LB  
United Kingdom

# INTRODUCTION

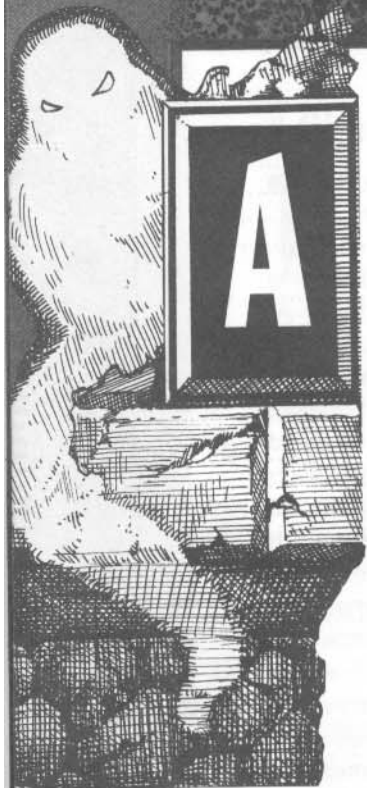

h, make the most of what we yet  
may spend,  
Before we too into the Dust descend;  
Dust into Dust, and under Dust,  
to lie,  
Sans Wine, sans Song, sans Singer,  
and sans End!

—Edward Fitzgerald

Welcome to the dark heart of Forlorn, brooding Castle Tristenoira. In this stony ruin, ghosts rule the night and mortals quake in fear until morning comes. Few enter the gloomy halls of this keep and live to recross its crumbling drawbridge. Those adventurers who have survived such a foray tell eerie tales of half-seen shapes, shifting hallways, and ominous shambling beasts. “All is not as it seems in Castle Tristenoira,” they say through

trembling lips. “Time itself has no meaning there.”

This adventure booklet is set entirely within the confines of Castle Tristenoira, and it serves as a climax to *Melancholy Meetings*, the other 32-page adventure booklet found in the *Castles Forlorn* boxed set. *Eve of Sorrows* brings together adventurers and the inhabitants of the castles three, providing a chance to solve several mysteries of this lonely domain.

Before reading this adventure, the DUNGEON MASTER™ (DM™) should read *The Weeping Land*, the 96-page source book included in this boxed set. Descriptions of all rooms in the castle are found there, as are the game statistics for all the major ghosts that inhabit the structure. DMs should be familiar with the history of Tristen ApBlanc, as well as the backgrounds of all the ghosts in the “Who’s Doomed” section of *The Weeping Land*, to clearly understand the events in *Eve of Sorrows*. This adventure is, in fact, several murder mysteries rolled into one. DMs should be familiar with dates, circumstances, and reasons for each of these deaths.

## What’s Needed to Play

**E***ve of Sorrows* is designed to be played by four to six player characters (PCs) at the 4th to 6th level of experience. Magical weapons are essential for combatting the castle’s spirits, and the PCs stand an even greater chance of success if they have a piece of deer antler consecrated to a druidic god or a holy symbol of Belenus (see “Howling Vengeance” [page 15] and “Shattered Secrets” [page 18] in *Melancholy Meetings*). Problem solving is the focus in this collection of scenarios because turning the ghostly inhabitants of Castle Tristenoira should be all but impossible for PCs at these experience levels!

Aside from the *DUNGEON MASTER™ Guide* (DMG) and the *Player’s Handbook* (PHB), it’s assumed that the DM owns a copy of the RAVENLOFT® *Realm of Terror* boxed set (1053) as well as the corresponding appendix of the *MONSTROUS COMPENDIUM™* (2122). *Van Richten’s Guide to Ghosts* (9355) also is highly recommended reading, but not required.

The following monsters may be encountered in this adventure: geist\*, goblyn†, gremishka\*, haunt††, lost one†, lycanthrope (wererat)††, rat††, worg††.

\* RAVENLOFT *Realm of Terror* boxed set

† RAVENLOFT *MONSTROUS COMPENDIUM*

†† *MONSTROUS COMPENDIUM*, vols. I and II

## Organization

**E***ve of Sorrows* has a free-form structure. Rather than list what each room contains, this adventure provides a number of *potential* locations in which each nonplayer character (NPC) or monster could be encountered, and where treasure or clues lie. As the PCs explore the castle, the DM should build tension gradually, saving the nastiest surprises for last. Ultimately, characters should be left with the feeling that they’ve painted themselves into a corner . . . with their own blood!

Note that all castle locations in this book are referenced to the poster map with a number in parentheses, for example, the castle entry (161).



# TEMPORAL SHIFTING

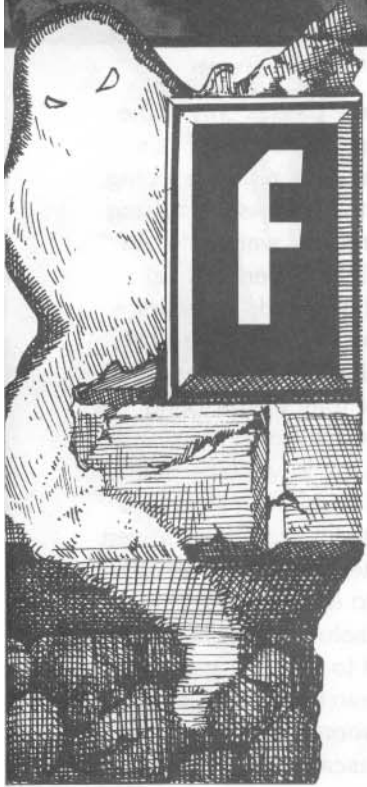

*or if such holy song  
Enwrap our fancy long,  
Time will run back,  
and fetch the age of  
gold. . . .*

—John Milton

A temporal shift may occur only when *all* of the characters in a group have gathered into a single area. At that point, the room they are in remains locked in its present time period, but the rest of the castle shifts. Only after everyone has exited that area does it realign itself with the new time period.

Temporal shifting can play havoc with basic physics and concepts of reality. For example, a character running a hand along a solid wall might suddenly discover an open space—a portal that exists only in the period outside the room the party is in! Only after the PCs have stepped through the seemingly invisible door will they discover which time period they have entered. Conversely, if the new time period *doesn't* contain a doorway which *does* exist in the room the PCs occupy, they will hit an invisible wall as they attempt to pass through it.

Simply stepping in and out of a room repeatedly will not cause a temporal shift. Rather, there are three suggested methods that DMs can use to determine when one occurs:

**1) Random Method:** The Castles Forlorn are filled with temporal shift triggers, each marked on the poster map with a P. When the PCs pass over one of these triggers, they have a chance to enter a different time period. After the party crosses one of these squares and then gathers within one area, roll percentage dice:

Temporal Shift	
01–33%	Castle A
34–66%	Castle B
67–99%	Castle C
00%	Special

If the time period determined by the die roll is the same as the time period the characters are currently exploring, there is no temporal shift.

Note the 1% chance that adventurers will randomly blunder upon a “special” time period, which is either the year 1594, in which Tristen’s parents were killed, or the year 2624 (Barovian calendar 1237), in which Castle Tristenoirea has been utterly destroyed and the lord has been freed of his curse. (See “Unholy Night,” on page 29, and “A Dire Warning,” on page 32.)

**2) Room by Room Method:** A DM can, each time the PCs enter an area that exists in more than one time period, roll percentile dice to determine if a temporal shift occurs. Again, the area they occupy remains in the same period and shows no sign of the switch, but the rest of the castle shifts around them. Hence, the PCs may exit the same door by which they entered an area, only to find the room they were in a minute ago completely changed!

The suggested chance for a room-by-room time shift is 20%. If this roll is successful, consult the Temporal Shift Table and roll again, ignoring any results that fail to produce a temporal shift. Note that physically or magically tunneling through a wall guarantees that the PCs will wind up in the same time period; only proper entrances serve as portals.

**3) DM’s Choice Method:** The DM may simply wish to change time periods at will. This method can give beleaguered PCs a break from a monster attack (monsters and NPCs always remain in their original time period) or suddenly spring an encounter on overconfident characters. Best of all, DMs can use temporal shifts at critical moments to make the game as eerie and frightening as possible.

# TEMPORAL SHIFTING

## The Flow of Time

There are three ways for DMs to measure time across the three periods:

**1) Independent Timekeeping:** Time progresses independently in each of the three time periods. While only a few minutes might go by in Castle A, an hour might go by in Castle B and three days might pass in Castle C.

The advantage of this method is that it allows DMs to speed up or slow down the time between key events, giving PCs more time (or less time!) to plan and carry out a rescue or counterattack. In other words, any amount of time may pass in other periods, allowing the DM to place the party in a new period at any hour of any day or night.

The drawback to this method is that it requires timekeeping in triplicate.

**2) Steady-State Timekeeping:** Time progresses at the same rate in all three time periods. In other words, if 10 minutes go by in Castle A, the same amount of time passes in Castles B and C. Time is measured at the rate at which the PCs experience it.

The advantage of this method is that it requires only one timekeeping chart. The disadvantage is that DMs must constantly calculate how far the action in other time periods has progressed since the last encounter. Has enough time passed for an NPC to have healed? How far could monsters have moved and where are they now?

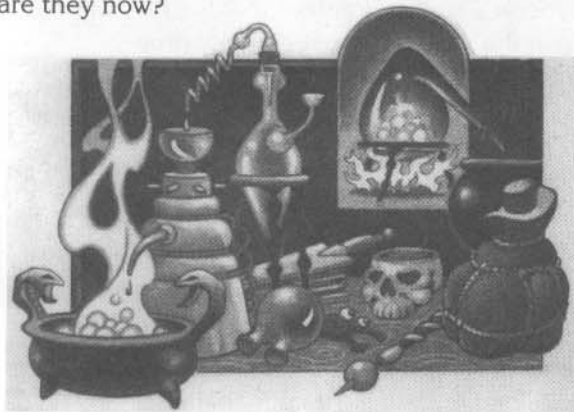

**3) Frozen Timekeeping:** Time passes only in the time period that the PCs currently occupy. This method is the simplest in terms of record keeping. However, it's the least flexible in terms of allowing a DM to shape the adventure. PCs waiting for an event to happen in a specific time period must enter that era and wait until the incident occurs. Also, DMs using this method must keep track of the location of all NPCs at the moment of any temporal shift. This is where they will be found once time restarts in that time period.

Some PCs might try to take advantage of this particular flow of time. If they know a wounded Tristen is "frozen" in a particular room of a given time period, they might attempt to rest and heal in another time, planning to return and finish him off later. A suggested solution to this ploy is that the temporal shift fails to take them to the same time period, or it doesn't occur at all. If the PCs then go to a different room to attempt the desired time shift, Tristen escapes by the time they get back to his room.

## Entering and Leaving the Castle

**T**ristenoira can be entered or exited *only* in the time period of Castle C. Should adventurers find a portal in Castle A or Castle B that opens to the land beyond the castle grounds, they'll find themselves unable to pass through it by any means whatsoever. They can still hear sounds from outside, smell odors, and even feel wind and rain blowing through an opening, but any attempt to exit proves impossible. An unseen force prevents PCs from exiting the castle, and no spell or power can counter this effect. Note that the castle grounds include the entire area within the outer walls, even if they are not built yet—the PCs can walk outside of Castle A as long as they remain within the boundaries of the future outer walls.

Even though the PCs are unable to exit Castles A or B, NPCs and monsters can enter and leave the castle grounds at will. However, these creatures *always* remain in the time period in which they originated.



# TEMPORAL SHIFTING

## Separating the Party

**D**ungeon Masters should avoid the headache of trying to run multiple groups of characters through Castle Tristenoira, and they should discourage their parties from splitting up. However, if PCs insist upon going their separate ways, there's a possibility that the independent groups might occupy the same room at once—but in different time periods! This could present some amusing possibilities. For example, a *fireball* cast in Castle A might suddenly blacken the walls of the same room in Castles B and C, while a manuscript that was in the fireballed room of Castle A would abruptly crumble into ash in the future. If the PCs in Castle B were all killed, their skeletons might suddenly appear in the same room of Castle C!

## Same Lord, Different Period

**T**he PCs are going to meet, in effect, three (corporeal) Tristens in the Castles Forlorn—each in his own time period—but the DM should recall that all three Tristens are the very same person. Hence, the Tristen of Castle C (known simply as “the lord”) has all of the memories of Marc ApBlanc of Castle B and the minstrel ApBlanc of Castle A. Further, Marc has all of the memories of the young minstrel, but none of the knowledge of the Tristen in Castle C. The young minstrel, on the other hand, has no knowledge of events in Castles B or C. Similarly, those NPCs who are long-lived enough to exist in more than one time period (several of the ghosts, for example) may remember adventurers they have previously met, but they will not remember or have any knowledge of characters they have only met in a later time period.

Because Tristen doesn't experience temporal shifts, he has no knowledge of this effect. Thus, he will be amazed to discover that the mortals who challenged him in Forfar year 1839 returned 95 years later, in 1934, and he'll be even more amazed when they challenge him a third time in 2122, some 188 years later. He may assume, at

first, that the PCs are immortals, or that some magical device or spell has enabled them to survive for a longer-than-normal mortal life span, but as he encounters the characters time and again, the lord will begin to puzzle out what is happening, especially if the PCs are open with him about their experiences. The DM should remain sensitive to the moment when Tristen would realize that temporal shifts are occurring, for he would surely take advantage of such knowledge if possible. However, the DM should beware of temporal paradoxes that might occur as the result of such knowledge, and handle them carefully.

## Temporal Paradoxes

**T**he actions of the player characters present the possibility of some odd contradictions between the past, present, and future. Their interaction with the various NPCs can change history that they've already experienced or even eliminate some of those NPCs from history altogether. Similarly, the PCs' treatment of objects and the castle itself in any time period can affect the other two castles. This section attempts to address those possibilities.

## People

As the PCs shift between time periods and castles, they'll carry knowledge with them that can upset the natural flow of time. For example, if the characters injure Tristen in Castle C, then enter Castle A and tell a younger Tristen about the encounter, it is arguable that the older Tristen will have been forewarned about it and might take steps to avoid becoming injured. In that case, the Castle C encounter wouldn't necessarily happen exactly as it did. Under these circumstances, it's entirely possible that Tristen wouldn't be injured in Castle C, which means that the PCs could not have told the Tristen in Castle A about how they hurt him (since now it didn't happen!), which means that he couldn't take steps to avoid the situation, which means that he

## TEMPORAL SHIFTING

would be injured after all, which means . . . running a campaign in Forlorn could become impossible!

It is simpler, for gaming purposes, to assume a “no replay” rule and follow a linear sequence of events, based on play of the game. In other words, if an encounter in a particular time period has already taken place, contradictory encounters that occur later in the game (but in an earlier time period) can not force a restructuring or replaying of that event. For simplicity’s sake, the injuries Tristen received in Castle C (in the above example) would stand, no matter what the PCs tell him in Castles A or B. As a simple rationale, Tristen will not accept or comprehend knowledge of his own future, even if he understands that the PCs are somehow moving through time. This solution is much easier than allowing Castle A’s Tristen to avoid damage taken in Castle C, thus nullifying earned experience points, PC-sustained injuries, cast spells, and so forth.

The PCs also may create a temporal paradox by altering the fate of an NPC. If, for example, the adventurers somehow save Isolt ApBlanc from death in Castle A, then she logically cannot become one of the spirits that haunts Castles B and C, even though the PCs may already have encountered her there. To counteract PC actions that may result in such a paradox, the DM need only explain that events outside of the PCs’ sphere of influence have undone whatever they attempted. For example, if characters learn that a druid in the dungeons of Castle C will be killed and they proceed to Castle B, to make arrangements for a warning to be passed on to the druid when he is born, the note is lost or disbelieved. Likewise, if the PCs free an NPC from Castle B whom they have seen murdered in Castle C, the NPC is recaptured after the PCs take their leave of him, and he dies as scheduled, later on.

### Objects

Still other temporal paradoxes might occur if the PCs manipulate objects and areas that exist in

more than one castle. For instance, if the PCs remove an object from a room in an earlier time period, it will not be present in later versions of the castle, even if characters have already seen it there in a later time period. Similarly, if a room is destroyed or suffers damage in Castle A, that havoc will be present in Castles B and C, even if the PCs saw the room intact in a later time period, but at a previous point in the adventure.

In order to track the status of objects affected by PC actions, the DM should carefully keep a record of the original room and time period of every item the PCs find. Then, should the party enter the same room in a previous time period, the DM will be prepared to determine the fate and location of those items that were supposedly found “later.” Even after an item has been found and removed from a room by the PCs, it is still subject to past events. For example, an old manuscript discovered and taken from Castle C would suddenly crumble into ash if the party subsequently entered Castle A and cast a *fireball* into the room where the very same (but now new) manuscript lies.

Conniving players who figure out that temporal shifts are occurring might attempt to triple up on useful items. Upon finding a magical sword in Castle C, for example, they might seek to enter Castles A and B and retrieve the sword a second and third time, hoping to garner three weapons for the price of one. The solution to this paradox is obvious: The sword taken from Castle C may well be found in Castle A, but as soon as a PC takes it, the sword that was recovered from Castle C vanishes. In other words, the sword removed from Castle A was never there for characters to find in Castle C.

To sum it up, unless altering the future is allowed for in the adventure booklets, or unless the DM is comfortable with repeatedly adjusting history to agree with any PC action, any attempt to do so should fail. Temporal paradoxes can be a lot of fun or thoroughly confusing; if the latter proves to be the case, abandon attempts to make perfect sense of the facts and concentrate on just having fun with them.



## TEMPORAL SHIFTING

### Defeating the Lord

**R**ecognizing all three vampyric Tristens—and his ghost—as the same being *and* the lord of Forlorn, let alone destroying him, should be a formidable task. Later versions of Tristen may retain injuries or scars suffered in earlier time periods, making it possible to connect the three figures, but identifying him as the lord is another story and destroying him should be all but impossible. Truly killing Tristen could eradicate a core domain of Ravenloft!

Tristen can be permanently destroyed if the PCs manage to learn that he becomes mortal and comatose during each solstice and equinox (see page 20 of *The Weeping Land*) and if they discover and penetrate either of his sanctuaries (areas 156 and 158 on the poster map), but Tristen also is vulnerable to real defeat if the PCs find their way into 1594, the year in which Tristen was born, and follow the proper course of action dictated in the “Unholy Night” encounter,

on page 29 of this booklet.

If Forlorn is left without a lord, there are three possible fates of the domain. The easiest resolution is to install a new lord. If Tristen is eliminated during a solstice or equinox, then the overall makeup of Forlorn remains the same and either Herrd of Clan ApKie or any of the ghosts in the castle may become the new lord. An interesting follow-up adventure might involve determining who will inherit the lordship. If Tristen’s past is altered, Andrew ApFittle could fall from paladin status and virtually repeat Tristen’s history, in which case the ApBlanc family would become the ApFittle family, fulfilling Forfar’s destiny to become Forlorn. The second possible outcome of destroying Tristen is for Kartakass or Barovia to swallow the suddenly ungoverned land. Perhaps a war of werebeasts and undead might develop over the possession of the new territory. The last possible fate of Forlorn is for it to fade away, in which case the DM takes a magic marker and inks Forlorn off the Ravenloft map.



## MAJOR HAUNTINGS

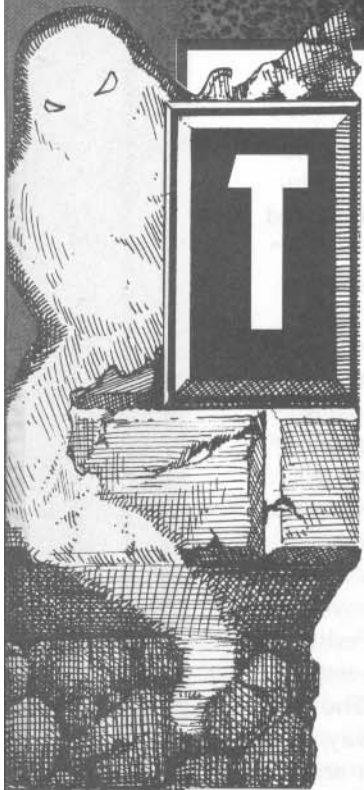

hey glided past, they glided fast,  
Like travelers through a mist;  
They mocked the moon in a rigadoon  
Of delicate turn and twist,  
And with formal pace and loathsome  
grace  
The phantoms kept their tryst.

—Oscar Wilde

Each ghost of Castle Tristenoir has a part to play in revealing the sordid history of Forlorn. As each haunting is investigated, another piece of the puzzle falls into place. This section provides the clues that each ghost can reveal about Tristen as well as typical locations for each ghost within the castle and possible encounter scenarios. For complete game statistics, histories, and behavior patterns of each ghost, see *The Weeping Land*.

### Tristen ApBlanc

**T**risten's ghost can be encountered anywhere in the Castles Forlorn, in all three time periods, but only at night. The DM should take care to conceal his identity as the lord. The PCs may soon decide that a ghost is the lord of Forlorn, but they will not know *which* ghost. While the highly charismatic vampyre Tristen attempts to bribe and cajole PCs into helping him escape the effects of Rual's curse by day, his incorporeal spirit attacks by night those whom he feels have either turned against him or who stand a chance of convincing others to do so. Tristen by day is a sympathetic and friendly character, but Tristen by night is always an evil and violent force. He will not act foolishly, but he will certainly treat the PCs as a real threat.

The ghostly Tristen will automatically attack anyone entering areas 135, 138, 140, 156, 158, 163, 166, 168, 169, 170, or 171 (see the poster map of the castle). The chance of him being on hand to observe the intrusion is 20%.

#### Suggested scenarios

- While walking through the courtyard at night, the PCs hear soft crying noises coming from the tombs (area 34, 35, or 36). If they open any of the three doors, they see a ghostly figure draped over the sarcophagus inside. A low moan escapes the figure's lips: "Why? Why did you have to die?" Then the ghost notices the PCs, his face twists with rage, and he rushes them. Sweeping through one of the PCs, Tristen uses his ability to *cause revulsion*, then disappears into the ground.
- The PCs are exploring the armor display room (area 38). If the PCs lift the visor of the suit of armor, it proves to be occupied by the ghost of Tristen. Stepping through the armor, Tristen locks gazes with one of the PCs, uses his ability to *accelerate aging*, then disappears through a wall.
- The PCs are exploring the artist's studio (area 75). If they search the north turret, they discover a painting in the shadows behind the chair there, covered with a dust cloth. Lifting the cloth reveals a life-sized and lifelike portrait of Tristen in ghostly form. As they look at it, the ghostly Tristen emerges from the painting and attacks the PCs.
- (Castle B only) The PCs hear Tristen keening in the dining room of the grand hall (area 13). If they investigate, they find six dead humans seated around the dining table, their faces fallen into their food—mercenaries who have displeased Tristen.
- (Castle C only) The PCs hear strains of eerie harp music emanating from the dance hall (area 98). Investigating, they see two goblins moving with jerky motions in a grotesque parody of a waltz while Tristen watches. He notices the PCs and disappears through a wall. The goblins, whose dead bodies were controlled by Tristen's *dominate victims* ability, fall lifeless upon the floor.



## MAJOR HAUNTINGS

- The PCs enter the audience chamber (area 79). There, sitting on his throne, they find Tristen drumming his ghostly fingers on the arm of the chair. Without lifting his eyes, Tristen says, “Yes? Speak quickly, and if your request is reasonable I will grant it.”

No matter what the PCs ask, Tristen’s reply will be terse: “Denied! Leave or die!” The PCs will have just enough time to scramble out of the room and down the hall before Tristen begins to *keen*.

- If the PCs are near area 140 at dusk, they hear screams of agony. Tristen has chosen this place to abandon his body today, as he transforms from vampyre to ghost. If they reach the room within two rounds, the PCs witness his final death throes and must make horror checks. Tristen’s ghost immediately attacks with intent to kill the witnesses. Henceforth, Tristen will openly seek to imprison or murder the PCs.

### Rual

**T**risten’s foster mother is a ghost in all three time periods. When first encountered, she appears simply as mist and should be presented by the DM at a time and place that will alarm the PCs. Meanwhile, the vampyre Tristen constantly seeks to engender fear of Rual in the PCs, attempting to enlist their aid in an attack against “the evil lord.” If the PCs take up an offensive against the ghostly druid, Rual becomes hostile towards the PCs in subsequent encounters and time periods in which she has a memory of those hostilities, even after the PCs learn that she is not the lord of Forlorn.

If the PCs have encountered the ghost of Flora ApBlanc in the courtyard, they have heard her speak Rual’s name and may realize that the druid is the person to whom Flora was trying to give her baby. If they can question her about that baby, Rual says, “That child should have been put to death! Blood always tells true. If I had known then what I know now . . . but there is no way to turn back time.”

A nonhostile Rual also can reveal that the baby’s name was Tristen and that he was the son of the vampire Rivalin ApTosh and the mortal Flora ApBlanc. She can provide a summary of Tristen’s life, up to the moment of her own death. From that point on, Rual’s memory becomes sketchy. Although she became a ghost immediately upon dying, she was not always present to witness key events. Hence, she has no information about Isolt and the children or his minions and captives.

Rual’s key function is to alert the PCs to the fact that the minstrel ApBlanc, Marc, and Tristen are one and the same person, should they fail to come to that conclusion themselves. She also hints that if Tristen had been killed as an infant, then Forfar might never have become the evil domain of Forlorn. Obviously, this information will resolve many key secrets of Forlorn, so the DM should withhold key interaction with Rual until the PCs have exhausted their search of the castle or until they become hopelessly confused.

In the meantime, Rual has a malevolent hatred for Tristen, and she will provide any information that will enable PCs to torment the lord. She doesn’t want him to be killed and released from her curse, so she can still interact with the PCs and purposely withhold information that would lead to his exposure.

### Suggested Scenarios

- The PCs are talking with the vampyre Tristen (in any time period). Rual appears in mist form, creates an illusion of the sacred grove, and re-enacts her murder. Tristen reacts with a mixture of horror and rage to this scene, and then attempts to convince the PCs that they have just met the lord of Forlorn and witnessed one of her evil delusions. If the PCs are persuaded to attack Rual, the illusion of the sacred grove then transforms into a blighted forest and Rual attacks Tristen. Allow the PCs to believe that Rual is attacking them, too—she will defend herself if they attack her.

# MAJOR HAUNTINGS

- (Castle C only) Rual uses her ability to *lure victims* to draw the PCs into the prison cells (area 148). There they encounter an imprisoned druid. Rual does this not out of pity for the druid, but as a way of irritating Tristen.

Alternatively, this scenario can be used to lead the PCs to Brangain's prison cell, in area 166 (Castle A only).

## Isolt ApBlanc

Isolt ApBlanc exists as a ghost in Castles B and C, but she is still alive in Castle A. Her ghost can be found anywhere in the castle, endlessly searching its rooms and corridors. She does not, however, know of areas 151–158 or areas 163–171, so she is never encountered in those locations. The most logical places to find the ghostly Isolt (50% chance) include her tomb (area 36), Brangain's bedroom (area 99), her own bedroom (area 119), the unfinished chapel (area 134), or the sick room (area 137).

### Suggested Scenarios

- If the PCs are badly hurt, Isolt appears and leads the party to the sick room (area 137), where she points to the cabinet on the south wall. In its drawers, they find three doses of one of the following potions (roll 1d4): 1) *elixir of health*, 2) *potion of extra healing*, 3) *potion of healing*, 4) *potion of vitality*.  
On the other hand, due to the ghostly Isolt's evil nature, she might lead a healthy party to one of the following (DM's choice): *potion of delusion*, *elixir of madness*, *poison* (Type J). The DM can also have Isolt aid the party one time, then mislead and injure them the next.
- (Castle B or C) The PCs discover the ghostly Isolt in her bedroom, area 119, at the desk. She scribbles on a piece of paper, then rolls it up and places it inside a locked drawer of the desk (without even opening it first). She then rises and proceeds to area 136 (via 123, 124, and 132) and throws herself off the balcony, dissolving into mist as she falls.

If the PCs open the locked drawer, they find a very old and dusty note inside:

*Murderer!*

*Once, I called you my beloved. Even though I knew of the horrible curse you labored under, still I had hoped that I might, Diancecht willing, cure your malady and save you.*

*You speak of spending eternity together, but I have no wish to share immortality with you! What joy would it bring, with our two dear boys dead and our daughter irretrievably lost?*

*I believed that you shared my sorrow, but now I know in my heart that it was your own hand that struck Morholt down. What a foul, dark deed you committed that night!*

*You truly are a lost creature and you have brought ruin upon all of us! I see no solution but to bid this pale, dreary world farewell. Diancecht may spurn me as I run to his holy arms, but I would rather be forever damned than spend eternity with you!*

*Isolt*

- As the PCs explore the dungeons (area 148), they find either a townswoman (Castle B) upon whom Tristen has been feeding, or a female druid (Castle C) whom his minions have tortured. If the PCs have met Isolt and heard her pleas to find her daughter, they notice that the woman matches Brangain's description. Unfortunately, the prisoner is mad and cannot identify herself. If they free her and bring her upstairs, they are met by Isolt (who will make her plea if she has not done so already). If the PCs present the prisoner as her daughter, Isolt becomes enraged and attacks them, using her ability to *cause despair* and then casting spells.
- As the PCs attempt to rest in Castle B or C, Isolt wanders the hallways outside their door, calling for Brangain in a ghastly voice that prompts horror checks. PCs who are sleeping have nightmares and do not receive any benefits of a full night's rest.



## MAJOR HAUNTINGS

### Gilan ApBlanc

**G**ilan ApBlanc exists as a ghost in all three time periods. The most likely places to encounter him are his tomb (area 35), the courtyard (area 37), his bedroom (area 100), or the playroom (area 103). He is unable to reveal anything about Tristen, save for the fact that Tristen is his father. Gilan can describe three other ghosts who inhabited the castle when he was still a mortal boy: Rual, Flora, and Tristen. (Although Gilan can describe Tristen's ghostly form, he does not realize that this is his father.) Gilan believes that Morholt and Isolt are still alive. He can provide some information about his family, but only up to the year in which he died, and only from a child's perspective. He bursts into uncontrollable tears and fades away if asked to describe his own death.

#### Suggested Scenarios

- Gilan is in one of the kitchens (area 10, 15, or 108) or pantries (area 11, 47, or 107), feeding his ghostly dog Petitcreiu. When PCs enter, he begs them to cure his pet of the malady that has caused it to lose its appetite. When the PCs fail (or refuse), Gilan has a temper tantrum, using his ability to *perform telekinesis* to hurl items.
- In the courtyard (area 37), the PCs are attacked by wolves. When one of the wolves is wounded, it yelps in pain. Gilan's ghost emerges from his tomb (area 35), attacking the wolves and crying, "Leave him alone!" After a round, he screams, falls among the wolves, and fades away.
- Gilan yearns for someone to play games with him. In order to lure one of the PCs to play "hide and seek" with him, he telekinetically steals a prized possession (e.g., a magical item or weapon) and runs away with it. The resulting chase leads the PCs all over the castle. Gilan knows every inch of the castle in all three time periods. (This encounter can be used to lead PCs to secret doors.)

### Morholt ApBlanc

**M**orholt ApBlanc exists as a ghost in all three time periods. The most likely places to encounter him include any of the weapons rooms (area 6, 110, or 159), the weapons repair room (area 39), the duelling room (area 70), the guest bedroom in which he died (area 73), or his own bedroom (area 102).

Morholt can provide the PCs with information on his family up to the year in which he died. He knows the circumstances of Gilan's death and can tell PCs about his parents' arguments over religion. He does not know, however, the true nature of his father, and he doesn't realize that his father killed him.

#### Suggested Scenarios

- When the PCs explore area 134, they are met by Morholt, who challenges them to put forward a champion who will fight him "to the death." If they refuse, he calls them cowards and fades away. If they accept, he fights until he is destroyed or until the PC dies, at which time he fades away.

Lying on the floor in his place is a piece of folded paper which holds a small shard of metal, perhaps an inch long. When the PCs examine the note on the paper, read the following message:

To a most reverend daughter of Diancecht, from the holy Mother, written and sent in the year of the healer's mercy, 1833.

Lady Isolt:

While preparing your son Morholt for burial, we found this sliver of metal in his wound. It is obviously a piece of the blade that slew him. Although Duncan ApDuguid is fled, perhaps this will yet persuade his masters, the servants of the goddess Morrigan, to return him into your hands for punishment. If they seek and discover a notch in his sword to match this shard, they may at last believe that a fallen cleric of their order murdered an innocent man and the heir apparent of Clan ApBlanc.

## MAJOR HAUNTINGS

The weapon that killed Morholt was actually Tristen's sword, which is engraved with the initials "T.A." Tristen hid it in area 125, 135, 138, or 140 (DM's choice) years ago, and it has remained there throughout all three time periods. The sword is hidden inside a locked chest. Note the geist scenario on page 14, and be sure that the location of the sword agrees between that scene and this one.

- Morholt appears to a PC cleric, but instead of challenging the PC to a duel, he asks if the cleric is a priest of Morrigan. He follows with more questions about how one atones with an angry god. Morholt doesn't realize he's dead, and he's trying to figure out what happened to him and why Morrigan has abandoned him.

If the PCs make it clear to him that he has died, Morholt is astounded, swears he will find his murderer, and departs.

Later, at a point when the PCs will not automatically understand what has happened, a voice cries, "Father! How could you?" from the guest bedroom (area 73). If the PCs go to investigate, Tristen's ghost emerges through the door, attacks the PCs in a fit of rage for one round, and then flees. If the PCs break into area 73, a swirl of mist dissipates over the blood stain on the floor as they enter.

- Morholt is attacking one of Tristen's human henchmen/goblin minions. Drawn by the noise, the PCs arrive in time to observe only the end of the battle. The mercenary/goblin pulls a small book from his jacket and hurls it at the ghost, screaming, "Here! I don't want your book! Leave me alone!" The ghost replies, "But I want your life." He lands one final, fatal blow, bows to the corpse, and says, "Another soul for you, goddess." Then he disappears.

The book is the diary of Duncan ApDuguid, dated 1833. The last entry in the book reads:

*Tonight I have seen a most terrifying sight! A restless spirit has just accosted me as I exited the water closet. Fortunately, I was still wearing my robes and had a vial of holy water concealed within. I cast it at the apparition and sent it fleeing through a wall. Perhaps my eyes were deceived by sleepiness and the numerous toasts I had drunk earlier today with Morholt, but I will ward the bedroom against evil before I retire for the night.*

*How curious that these noble families live in apparent harmony with the walking dead! It cannot be Morrigan's will that such things occur. I must extract Morholt from this evil place as soon as possible—perhaps I can convince him to leave tomorrow.*

*Morholt is both a fine young warrior and an excellent candidate for the priesthood. Morrigan has gained another valiant servant. He is as chivalrous as he is brave. Tonight, he insisted that I take my rest in his own chamber while he takes the guest room and its lumpy bed!*

*I wish I could be as enthusiastic about the rest of his family. Morholt's mother and sister are fair enough. They worship the healing god Diancecht, a perfect counterpoint to our own beloved Morrigan, all praises to her!*

### Flora ApBlanc

**F**lora ApBlanc exists as a ghost in all three time periods. She runs from Birnam to the sacred grove every night at 11 pm.

#### Suggested Encounter

- When Flora finishes her nightly run, she swings from the rope as described on page 52 of *The Weeping Land*, but before she fades away, her eyes snap open and she looks upon the PCs with glassed-over eyes. (This can prompt a horror check.) Then Flora whispers in a strangled voice, "If there be pity in your hearts, then in my name plant a sapling in the sacred grove upon a holy day, and set right what was wronged!" This is the crucial clue that may lead to the "Unholy Night" encounter (see page 29).



# MAJOR HAUNTINGS

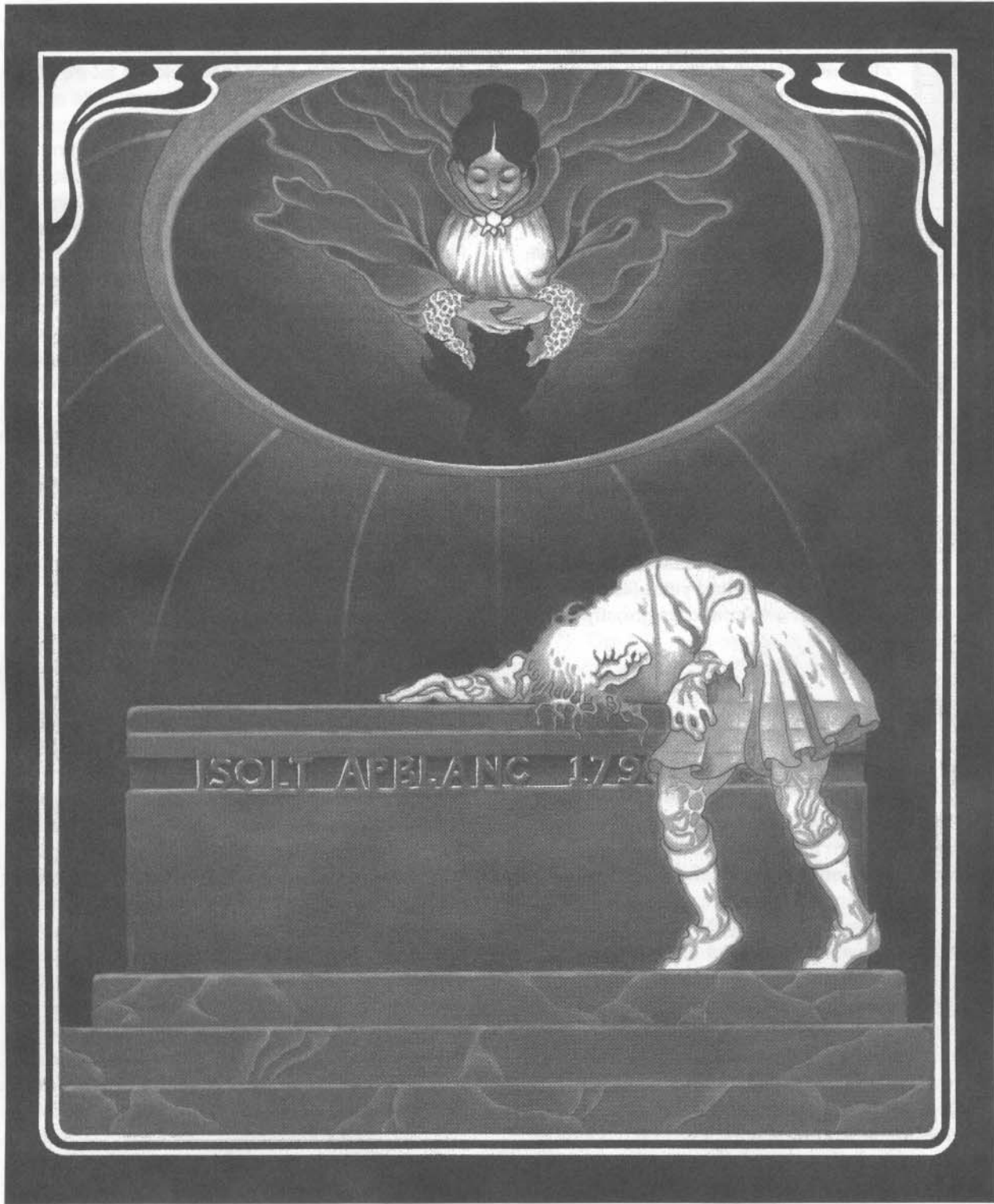

**Geist (Greater):** THAC0 nil; Dmg nil; AC 10; HD nil; MV FI 12; SA sight causes panic; SD invulnerable; MR 100% (see below); SZ M; Int varies; AL varies; ML 20; XP 0.

Note that geists manifest themselves within the minds of others, rather than actually appearing, so they cannot be physically attacked. Also, a geist is visible only to individuals of its choosing. Note that characters who take steps to shield themselves from mental attacks cannot perceive a geist at all.

There are several interesting and frightening ways to employ geists in the Castles Forlorn.

### Voices

Different PCs hear a woman whispering, "My lady Isolt I've found it!" on different occasions. In game terms, the DM writes a note to a player, expressing the occurrence, but declines to answer any question about it. All that is explained to the PCs is that when they turn around to seek the speaker, they see no one.

This type of haunting can be particularly terrifying if it occurs while the PCs are occupied with more pressing matters, or when they are attempting to remain silent or hidden. The DM can stretch out such auditory "hallucinations" over a great deal of the adventure before revealing the source of the voice.

When the proper time arises, the DM writes a second note explaining that the PC who heard the voice can now see the speaker. It is the geist of a woman dressed in servant's clothes, whose neck is broken and body is shattered. She hovers at just the right height to whisper in characters' ears. If there is a female in the party, the geist addresses her. If not, she chooses one of the PCs at random. She says, "Come my lady! Come quickly! I've found the sword that killed your son. The one with the notch in the blade. It's hidden in a locked chest in the south tower. Quickly, before my lord moves it."

The geist is the spirit of Isolt ApBlanc's personal maid. After she discovered the sword

*ut in dark corners of her palace stood  
Uncertain shapes; and unawares  
On white-eyed phantasms weeping  
tears of blood,  
And horrible nightmares.*

—Alfred, Lord Tennyson

Castle Tristenoira is filled with a number of geists and haunts, most of them victims of Tristen's vampyric feedings and his relentless persecution. Many of these undead creatures are linked to a specific location, but some of them wander the Castles Forlorn at will, adding danger and uncertainty to any exploration of its structures.

This chapter describes those two types of spirits in the Castles Forlorn, and it provides adventure scenarios in which to use them. They help create the tragic and eerie atmosphere that should pervade the adventure, as well as revealing yet a little more about the history of Forlorn and its ghostly denizens.



### Geists

Generally speaking, geists are relatively harmless spirits that are undead manifestations of a person caught between mortality and immortality at the moment of death. Most often they serve the dual purpose of frightening player characters and warning them of dire peril. Sometimes, however, a geist will deliberately lead PCs astray. The DM should consult the RAVENLOFT® *Realm of Terror* boxed set for more details about geists.

The geists encountered within the Castles Forlorn are all *greater* geists, which means that they have limited abilities to create illusions with both visual and audible components. These illusions tend to be transparent and cannot be used as spells of that school. PCs will usually recognize them for what they are, but they can still be used to generate fear.



## MINOR HAUNTINGS

with which Tristen killed Morholt, she herself was discovered by the lord and was hurled from the tower to her death. The weapon is hidden inside a locked chest in (DM's choice) either Room 125, 135, 138, or 140. (See page 12 and be sure that the location of the sword remains constant.)

### The Unexpected Bedfellow

The PCs are invited by the vampyre Tristen to stay the night. While sleeping in one of the guest bedrooms (areas 71[A], 84, 90, 113, or 115), one of the PCs rolls over and suddenly wakes up, feeling icy chills tickling his or her spine. In the bed beside the PC is the spirit of a man or woman in bedclothes that are soaked with blood. A wound in the geist's neck indicates a severed artery, and soon the bed is soaked with blood. The PC may be called upon to make a horror check. The geist tries to speak to the PC, but can only choke out the words, "Beware . . . He will . . . False . . ." After a moment, the geist and the blood fade away.

### Bedtime Reading

A PC finds a special book and thumbs through it. This encounter can take place in any room, but it is best set in the reading room (area 116) or in the library (area 135).

The book, entitled *Dawn of the Undead*, is lavishly illustrated with woodblock prints. One of them is a scene that bears an uncanny resemblance to the very room which the PC presently occupies. In fact, the person in the illustration is somewhat similar in appearance to the PC!

Then, the illustration begins to move. A dark figure creeps in behind the person reading the book, seizes the reader by the throat, then sinks fangs into his or her neck. If the PC continues to watch the moving illustration, a fear check is required.

If the PC moves, it becomes apparent that he or she is occupying the same space as a geist. The spirit finishes the enactment of being murdered by some unseen force and falls to the

floor. Close observation, before the image fades, reveals two livid puncture wounds in the geist's throat. Another look at the book proves that it has returned to normal.

### Window to Terror

(Castle B only) As the PCs explore the grand hall (area 46), eerie outlines of the figures in the stained glass windows begin to form. Up to seven geists appear, each one in the semblance of his or her death as depicted in the windows. PCs may be called upon to make horror checks.

The ApFittle geists surround the party in an apparently threatening manner, tormenting the PCs with predictions and warnings of impending doom and horrible death.

If the PCs attempt to communicate with the geists, they will not actually respond, but will study the PCs for a moment and then change their cries to invocations to avenge their deaths by killing Marc ApBlanc. The geists refer specifically and exclusively to Marc; they don't know him as either the minstrel ApBlanc or the lord, and they are unresponsive to questions.

The DM may choose to introduce individual ApFittle geists elsewhere from time to time. The geists can be destroyed if the windows representing them are smashed.

### Losing One's Head

(Castle B or C) A geist appears to the PCs anywhere on the second level of the castle. It is the figure of a man, holding his severed head in his hands. The spirit tries to push the head into the hands of one of the PCs. If the PC accepts it, the head seems to become real and the PC's hands grow slippery with blood; the PC may be called upon to make a horror check. Then the illusion vanishes.

If the PCs refuse the head, he turns and walks to area 51 and then area 50. If the PCs follow, they find a headless corpse (area 51) and a severed head (area 50). The geist wishes its head and body to have a proper burial.

## MINOR HAUNTINGS

### Haunts

**H**aunts are more dangerous than geists, for they seek to possess the body of a living being and use it to complete some task that has prevented them from resting. Of course, the body of the possessed character absorbs any damage incurred in completing the task.

**Haunt:** THAC0 15; Dmg 2 points of Dex per touch; AC 0; HD 5; hp varies; MV 6; SA see below; SD hit only by silver or magical weapons, or by fire (see below); MR nil; SZ variable; Int non; AL any; ML 16; XP 2,000.

The above stats detail the haunt in its natural state. When possessing a body, the haunt acquires the AC, MV, hp, and Dmg of the victim, but still attacks as a 5-HD monster. The haunt is trapped within a 60-yard radius of the place where it died until it possesses a victim through a series of touch attacks; each touch drains 2 points of Dexterity, and a PC reduced to 0 Dex is possessed and becomes an NPC until he or she is released. If the victim is of opposite alignment (good vs. evil) to the haunt, it forces the victim to strangle him- or herself, causing a single point of damage in the first round and doubling damage in each successive round until the haunt is driven out or the victim dies.

Upon possessing a body, haunts regain their former consciousness and intelligence. Those of good alignment will usually explain their task to the victim's companions in the hope that they will help or at least allow it to accomplish its job, while those of evil alignment will normally resort to trickery or force to realize their goals.

In their natural state, haunts suffer only 1 point of damage per silver or magical weapon hit, plus magical bonuses. Normal fire inflicts 1 point of damage as well, but magical fire inflicts full damage. A defeated haunt fades away and reforms in one week. *Dispel evil (good)* destroys the spirit, and failure to save vs. paralysis when a *hold person* spell is cast on a victim expels the haunt.

### Andrew's Rest

(Castle C only) The outside door to area 9 lies upon the skeletal remains of Andrew ApFittle. He rises in the form of a hovering, luminescent ball of light and attacks the nearest PC. Andrew seeks to smash the remaining stained glass window in the grand hall (area 46). When the other PCs realize that one of their party has been possessed, they are subject to a horror check, but Andrew will enlist their sympathies.

Andrew, a paladin in life, is of lawful good alignment. As a haunt he has 24 hp. (For Andrew's statistics as a paladin, see page 21.)

After the task is completed, Andrew may release the victim or he may continue to hold it and search for Tristen, in which case the PCs must convince him to release their companion. Any appeal to his good nature will suffice, but a promise to destroy Tristen works best.

### Dark Wizard's Regret

(Castle C only) While exploring either the guest room in the Lord's Tower (area 71) or the necromancer's laboratory (area 93), the PCs encounter the haunt of the necromancer Lucy ApMorten. Her image is nebulous and translucent, but it is clear that she died after literally being torn apart by someone or something with superhuman strength.

Lucy attacks the first PC to enter the room, seeking to possess the body. If this is achieved, Lucy uses the body in an effort to at last accomplish the task Tristen gave her—bringing Isolt back to life. Lucy will try to remove Isolt's corpse from her tomb (area 36) and bring it back to her laboratory, where she will conduct gruesome and useless experiments upon it. Any PCs witnessing a companion looting the tomb and performing these experiments are subject to a horror check.

Lucy's ghost is neutral evil in alignment and has 21 hp. (Lucy's living stats are on page 22.) If she possesses a PC of good alignment, she uses the victim's own hands to strangle that individual, then will resume her attack on another potential candidate for possession.



# MINOR HAUNTINGS

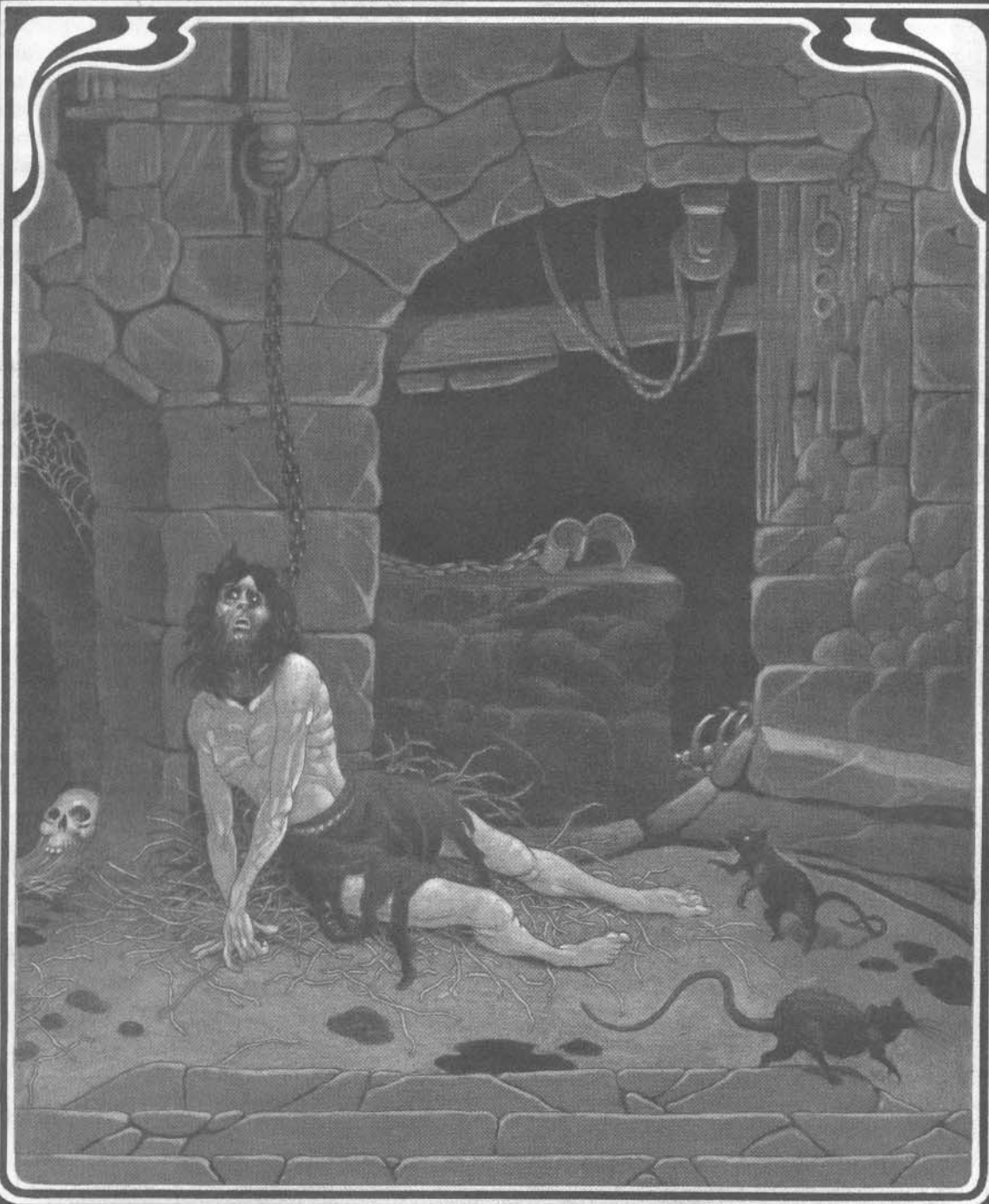

## NPCs AND MONSTERS

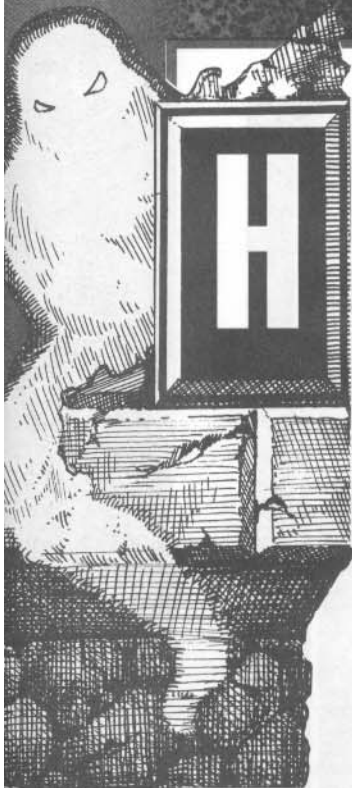

*e hath a thousand slain, this  
pestilence.  
And, master, ere ye come in his  
presence,  
Me thinketh that it were necessary  
For to beware of such an adversary.*  
—Geoffrey Chaucer

Several of the scenarios listed in the previous chapters call for the player characters to interact with specific NPCs and monsters. This chapter provides the game statistics for those various creatures.

As always, the idea of the “wandering monster” is completely inappropriate to the RAVENLOFT® campaign environment. However, the DM can introduce the beings included here whenever a spontaneous encounter is needed.

Just remember to keep it scary, and try to make such encounters fit into the overall structure of the adventure.

### Castle A—The Lord’s Tower

**T**he inhabitants of this castle think themselves in the Prime Material province called Forfar. There are fewer ghosts here, and many more humans, the most common of which are the castle servants. The following summary may be adjusted for variety if the DM wishes.

**Castle Servants (0-level humans):** THAC0 20; Dmg 1d4 (knife); AC 9; hp 3; MV 12; ML varies; AL varies; XP 15 each.

Most of the servants (75%) are neutral evil, have a morale that is steady (12), and are loyal to Tristen only (they only pretend to follow the orders of Isolt). The rest of the staff is neutral good and loyal to Isolt, but most of them are too frightened of the lord to directly oppose him. Their morale is unsteady (7).

The servants can be found at a variety of tasks around the castle: cleaning rooms (areas 5, 7, 8, 38, 70, 72, 97, 98, 121, 124, 137, and 139), sweeping hallways and entryways (areas 9, 74, 123, 132, and 133), preparing meals (area 10), checking and restocking store rooms and pantries (areas 11, 41, and 42), tending the tombs (areas 34 and 35), serving meals (areas 40, 69, and 122), washing up (area 44), hanging fresh bundles of scented herbs in the water closets (areas 43, 101, and 120), tidying up bedrooms (areas 71 and 119), or fetching water from the well (area 150). When not going about their daily routines, the 12 servants who live at the castle rest or sleep in their rooms (areas 126–131).

Large numbers of servants are also employed as gardeners, and they are constantly busy on the grounds, pulling up any and all kinds of plants in an effort to keep the grounds clear. These individuals live in the village of Birnam.

Only the most trusted servants are allowed into the lord’s private rooms (areas 125, 135, 138, and 140), and only when he is present.

**Mercenaries (F6):** THAC0 15; #AT 3/2; Dmg 1d8 (long sword); AC 5 (scale mail and shield); hp 40; MV 9; ML 14; AL NE; XP 300 each.

In Castle A, the lord employs only a handful of mercenaries. Six fighters are sufficient to deal with intruders and guard his dungeons (areas 145–149 and 166–167). At the DM’s option, a 7th-level captain of the guard may be added to the company, wearing banded mail (AC 4) and wielding a two-handed sword.

They sleep in shifts, on palettes which they toss on the floor of the weapons room (area 6) or the weapons repair room (area 39). Two can be found sleeping here at any time; the other four are always on duty. They have the use of a water closet (area 43) and can rest in the armor display room (area 38). They eat in their own mess hall (area 69). Under their armor they all wear tunics bearing the ApBlanc crest: a mailed fist gripping a white feather.



## NPCs AND MONSTERS

The townsfolk of Birnam are a sturdy lot, classified as 1st-level fighters. The DM can spontaneously adjust AC, hit point totals, weapons, etc. The men all wear tartan kilts while the women all wear long dresses with tartan shawls.

**Townsfolk (F1):** THAC0 20; Dmg by weapon; AC 10 (variable); hp 6 (variable); MV 12; ML 12; AL N; XP 75 each.

The townsfolk of Castle A are visitors. They owe their allegiance to Lord and Lady ApFittle, in the village of Birnam. All is well in the land, but if questioned, the townsfolk will discuss the tragedies that have struck the minstrel ApBlanc and his family. They know that Gilan died when wolves savaged him and that Morholt was killed by an assassin, rumored to be a fellow cleric, but they cannot give details.

Visiting townsfolk in Castle A might be used in any of the following adventure hooks:

- Admiring the minstrel ApBlanc's latest trophy in the foyer (area 5). The head is that of a stag. Strangely enough, the antlers have been cut off and disposed of.
- Enjoying the fire in either of the sitting rooms (area 8 or 97) while the young minstrel plays a tune for them on the recorder.
- Discussing the merits of various types of armor in the display room (area 38). They might be overhead wondering why the young minstrel needs such fine armor when he never goes to war—or sets foot outside his keep, for that matter.
- Enjoying a sumptuous meal with the young minstrel and his wife Isolt in the dining hall (area 40). The dinner conversation will be bright and cheerful until one of the townsfolk has the bad taste to mention Brangain's disappearance.
- Sparring with the minstrel ApBlanc in the duelling room (area 70). If the PCs enter unexpectedly, the lord is distracted. His opponent pierces his side with a thrust. The young minstrel falls to the ground, bleeding profusely (this is the stain mentioned in the

entry for this room). He politely but firmly refuses all offers of assistance, saying his wife Isolt will heal him. He then rushes away so no one will see his body regenerate.

- Sleeping overnight in the guest bedroom (area 71). Should the visitor be someone who will not be readily missed, the lord will spirit him or her away to his dungeons for later feedings. He will explain that his guest had to depart suddenly on urgent business.
- Playing a game of chess with the young minstrel in the games room (area 72).
- Painting portraits of the ApBlancs in the studio (area 75).
- Attending an evening ball in the dance hall (area 98). Since it is after dusk, Isolt will be acting as hostess. Tristen has excused himself and gone to revert to ghostly form.
- Visiting with Isolt in the sewing room (area 121). When Isolt leaves the room for a moment, PCs hear the townsfolk commenting in hushed voices that their host has been looking very pale lately.
- Being treated by Isolt in the sick room (area 137). The PCs may overhear the person ask Isolt why work on the chapel (area 134) is going so slowly.
- Languishing in a prison cell (area 148). This person is currently being used by the lord as a source of blood for his feedings.

### Castle B—Castle ApBlanc

**D**uring the time period of Castle B, there are only a handful of trusted (neutral evil) servants. These attend to the lord's personal needs, caring for his clothes, tidying the few rooms he still uses, and cooking his meals. Their gaming stats are identical to those of Castle A.

Due to the ominous earth tremors and the frequency of monsters in this "Time of Terror," only a few rooms are still tended by servants. These include two kitchens (areas 15 and 108), two pantries (areas 47 and 107), a warming room (area 48), the games room (area 72), the

## NPCs AND MONSTERS

audience chamber (area 79), the waiting room (area 82), the lord's bedroom (area 89), a few of the guest bedrooms (areas 84 and 90), two sitting rooms (areas 97 and 109), a reading room (area 116), and two water closets (areas 78 and 87). The rest of the castle is still in use, but is dirty and dilapidated.

Most of the time, the three remaining permanent servants can be found in their bedrooms (areas 16 and 17), where they have hidden away valuables looted from the castle. Sacks filled with silverware, bottles of fine wine, coins, and ornaments are hidden under the beds in readiness for the day they will flee. When not planning for their escape, the servants bolster their courage by raiding the wine storage (area 41). Their morale currently is unsteady (5). The servants avoid the other wine storage room (area 49), knowing that several of the bottles in it are filled with poison.

The castle also employs four specialized workers: three carpenters who cut beams in the shop (area 19) for shoring up the castle's cracked walls, a stone carver who works in an adjoining workshop (area 20), and a groom who tends the horses in the stables (area 22). These servants are housed in bedrooms in the guest tower (areas 50 and 51). Only the stone mason continues to put any effort into his work. The others pass their time by drinking ale from the store room (area 54). The stonemason's morale is average (10), and the morale of the three carpenters and the groom is unsteady (5).

By the time of Castle B, Castle ApBlanc has more mercenaries than servants. The lord has just concluded a successful war, toppling the ApFittle family. Although they were victorious in battle, a number of the soldiers in Tristen's army have since fled, for it is the "Time of Terror." Only 27 of the bravest stayed on, hoping to curry favor with their lord by sticking with him through these difficult times.

Castle B mercenaries are identical to those of Castle A, except that their moral rating is only average (9). They can be found anywhere in the castle, and the PCs will typically encounter 1d6

of them at a time. The mercenaries guard prisoners in the dungeons (areas 145–149 and 166–167), patrol the castle walls (area 111) and tunnels (areas 4, 23, 26, 28, 30, 58, 59, 62, 68, 91, 92, 94, and 95), guard the main entrance to the castle (area 29), operate the portcullis machinery (area 64), stand lookout in the archers' post (area 112), and maintain the weapons (areas 6, 39, 98, and 110). They eat in either their mess hall (area 69) or what used to be a sitting room (area 97) and sometimes take their supper with Tristen in the dining hall (area 13). They bathe in tubs in the laundry room (area 44). The mercenaries sleep in what used to be the servants' bedrooms (areas 126–131) and in what used to be the seamstresses' workshop (area 55). The captain has a private bedroom in area 105. Six of the highest-ranking mercenaries have horses; these are kept in the stables (area 22).

In the time period of Castle B, visitors to Castle ApBlanc are few and far between. Cowed by Marc ApBlanc's victory over the ApFittles, they are subservient and fearful of their new lord. Now that the "Time of Terror" has begun, they come to beg Marc to use his remaining mercenaries to drive off the strange and terrible monsters that have increased dramatically in number in recent months.

Visiting townsfolk in Castle B might be found in any of the following scenarios:

- Trying to steal weapons from one of the weapons rooms (area 6 or 110). The person believes there are magical weapons here, concealed among the ordinary pieces of equipment. Alternatively, the townsfolk might be trying to sabotage the weapons of the lord's mercenaries.
- Protesting the death sentence of Andrew ApFittle, who is to be hauled up from the dungeons, tied to the outer door of the entrance hall (area 9), and shot dead by archers in the courtyard (area 37). The protesters are immediately arrested and executed by Marc ApBlanc's men. A few folks are captured and imprisoned.



## NPCs AND MONSTERS

- Trying to start a fire in the carpentry workshop (area 19). These saboteurs hope to burn the castle to the ground.
- Hiding inside the unused carriage in the stables (area 22). This townsfolk was a victim of one of the lord's feedings. Puncture wounds are clearly visible on his neck. Suffering the effects of mental shock (see the "Fear and Horror Checks" section of the *RAVENLOFT® Realm of Terror* source book for details), he is unable to tell the PCs who his attacker was and refuses to emerge from hiding, even though he is clearly malnourished and in need of food. If confronted by the lord, he flees in terror.
- Drinking a toast with Marc ApBlanc in the grand hall (area 46). The townsfolk are former retainers of the ApFittles who hope to earn the lord's trust and rescue Andrew ApFittle, but the lord has seen through their plans and is serving them some of the poisoned wine from his special storeroom (area 49). It is Type J poison. The lord drinks from the same bottle—poison has no effect upon him.
- Pledging allegiance to Marc ApBlanc in the audience chamber (area 79). This delegation of six townsfolk will be presenting Marc with a chest containing 3,000 gp, 6,500 sp, and 10 gems in an effort to buy the life of Andrew ApFittle. The lord will accept the treasure, then signal the 12 mercenaries in the room to murder the delegation.  
Alternatively, the delegation could be sitting in the waiting room (area 82) awaiting an audience with the lord. They are arguing about the prospects of success for their mission.
- Languishing in a prison cell (area 148 or 166), awaiting execution by the lord's mercenaries for refusing to pledge allegiance to Marc ApBlanc.

### Andrew ApFittle

#### 8th-level Paladin, Lawful Good

Armor Class	8	Str	17
Movement	12	Dex	16
Level/Hit Dice	8	Con	14
Hit Points	20 (60)	Int	15
THACO	13	Wis	13
No. of Attacks	1	Cha	17
Damage/Attack	1d4+1 (fist plus Strength)		
Special Attacks	see below		
Special Defenses	see below		
Magic Resistance	nil		

Andrew, last of the ApFittle family (or so Tristen believes) has been imprisoned in the dungeons for more than a year. When the PCs enter the time period of Castle B, Andrew is being held in the center cell of area 148. After the time period of Castle B, but before that of Castle C, mercenary guards will haul him up to the courtyard, tie him to the door leading into the entry hall (area 9), and execute him.

As an 8th-level paladin, Andrew is immune to disease and can cure up to 16 hit points of damage, once per day. Twice per week he can cure nonmagical diseases by laying on hands. Because the land is on the verge of entering Ravenloft, Andrew is unable to detect evil intent—he takes this as a sign that the gods are deserting him. He is, however, still protected by a 10-foot radius aura of protection that imposes a -1 penalty upon evil creatures' attack rolls. He also can turn undead as a 6th-level cleric (on the *RAVENLOFT®* turning undead chart— see the boxed set), and he receives a +2 bonus to his own saving throws.

Despite this formidable array of abilities, Andrew is unarmored, weaponless, and badly debilitated by his captivity. Normally he would have 60 hp, but he now has only 20. His morale has ebbed, due to a recent attack by a wererat that crept into his cell. Andrew now suspects he is carrying lycanthropy. If rescued by the PCs, he will be recaptured after the PCs leave the time period and returned to the castle to face execution, as scheduled.

## NPCs AND MONSTERS

### Lucy ApMorten 12th-level Necromancer, Lawful Evil

Armor Class	9	Str	17
Movement	12	Dex	15
Level/Hit Dice	12	Con	12
Hit Points	30	Int	14
THACO	17	Wis	16
No. of Attacks	1	Cha	10
Damage/Attack	1d4 (dagger)		
Special Attacks	spells		
Special Defenses	spells		
Magic Resistance	nil		

When the PCs arrive at Tristenoira and first enter the time period of Castle B, Lucy will be hard at work in her lab (area 93), trying to cast a spell that will bring the dead Isolt back to life (not animate or reincarnate her). When not casting spells, Lucy can be found resting in her bedroom (area 71).

If the PCs believe that a vampire is in the

castle, they can be led astray by allowing them a glimpse of Lucy using her *spider climb* spell. Vials of blood in her laboratory can enflame the PCs' suspicions.

Lucy actually knows how to resurrect Isolt, but she is deliberately causing her spell to fail. She is infatuated with Marc and hopes to turn his attention and affection toward herself, instead. The lord will ultimately discover Lucy's guile and kill her in a fit of rage. Her body will be given to the goblins to eat.

Spells (4/4/4/4/4/1, plus one additional necromancy spell per level): *Cantrip, chill touch, detect undead, protection from good, spider climb; alter self, darkness 15' radius, detect invisibility, spectral hand, wraithform; dispel magic, feign death, fireball, hold undead, vampiric touch; contagion, enervation, Evard's black tentacles, extension I, polymorph other; animal growth, animate dead, cloudkill, magic jar, summon shadow; death fog, reincarnation.*





## NPCs AND MONSTERS

### Castle C—Tristenoira

This castle is inhabited only by ghosts, goblins, and a few other assorted monsters. There are, however, a number of druid prisoners present as well. When the PCs enter Castle C, the lord has 1d4 druid prisoners securely locked away in the cells (area 148) beneath the Lord's Tower. (For simplicity, these prisoners have been classified as 4th-level druids, but the DM is free to vary the levels.) The prisoners are guarded by six goblins. One by one, they are tortured for information in area 146.

**Druid Prisoners (P4):** THAC0 18; #AT 2 (fists); Dmg 1d2/1d2; AC 10; hp 25; MV 12; ML 7; AL N. Possible Spells (3/2): *Combine, cure light wounds, light, purify food and drink; charm person or mammal, detect charm, dust devil, find traps, messenger, obscurement, snake charm, speak with animals, trip, warp wood.*

The above spells are available because they require no material components. However, because mistletoe is fundamental to druidic spellcasting (and these prisoners have none), any spell cast by a druid prisoner is 80% likely to fail. Indeed, their attempts to cast *messenger* and *warp wood* have either failed or proven inadequate to their needs. All druids are redheads and have innate spell abilities as well (see *The Weeping Land*, page 44).

If the DM prefers, the PCs can encounter a lone druid escaped from the prison cells, who begs the PCs to rescue the druids who are still trapped below. The druid is either hiding or is spotted running down a corridor. If the latter is the case, the PCs will first have to deal with 1d4 goblin guards in close pursuit of the escapee before attempting any rescue.

Druid prisoners will be followers of either Shelaugh or Maeve (see *The Weeping Land*). If members of both factions are present in the dungeons, the DM can portray them as being antagonistic toward one another, each faction blaming the other for their present predicament.

**Goblin Minions:** THAC0 13; #AT 2 or 1; Dmg 1d6/1d6 (claw/claw) or 2d6 (bite); AC 4; HD 4+4; hp 22 each; MV 12; SA -2 to opponents' surprise rolls (-4 if opponent meets goblin unexpectedly), face bite (victim save vs. spell to avoid 1d4/round additional, suffocation damage—witnesses make horror checks); SD nil; MR 10%; SZ M; Int low; AL NE; ML 20; XP 975 each.

If a goblin "feasts" (bites an adversary in the face—see page 33 of *The Weeping Land*), PCs may be called upon to make horror checks.

In the time period of Castle C, goblins freely roam Castle Tristenoira. Any area can hold 1d4 goblins and no time is safe; goblins are active day and night. Open areas are especially dangerous. PCs passing through the courtyard (area 37) are likely to attract the attention of 1d6 goblins. Once goblins have encountered the PCs within the castle, the lord instantly knows they are there, due to his telepathic link.

Certain areas of Castle Tristenoira guarantee an encounter with goblins. The entrance to the castle (area 162) is guarded by eight goblins, and four goblins guard the prison cells in the castle dungeons (area 145–149 and 166–167).

Additional encounter suggestions:

- The PCs hear a commotion coming from area 25. If they investigate, they find a building filled with gambling goblins, taking bets on gremishka fights. If they enter by way of area 24, they discover 1d4 goblins who tend the fighting gremishkas in their cages. In the pit room next door (area 25), a fight is in progress; 3d8 goblins crowd around the pit, roaring with glee as the creatures tear each other to bits. Upstairs in the viewing loft (area 61), another 2d4 goblins watch the fight with cracked mugs of sour-smelling brew in their hands.

As an alternative, the PCs might find the secret tunnel that connects area 25 with a passageway in the castle walls (area 23). They emerge into the pit room while a gremishka fight is in progress.

## NPCs AND MONSTERS

- The PCs hear the hammering of metal on metal in area 27. As they draw nearer to investigate, they hear cries of “No! Please!” issuing from area 63, where the goblins are planning to test one of their latest creations, an iron maiden, on a druid prisoner. The screaming will continue for five rounds, at which time the goblins slam the door shut on the druid.

If the PCs enter area 27, they find a goblin attempting to forge iron in a crudely built smithy. They are then attacked by 20 goblins, who sneak up from behind if possible.

The torture devices upstairs are poorly made. If the goblins slam the door shut (in the fifth round), it falls off and then both iron maidens come down, bringing the roof with them. The druid inside is impaled on spikes and dies immediately. PCs in area 63 are buried under debris and sustain 2d8 points of damage (save vs. paralysis for half). At the DM’s option, PCs within 5 feet of the stairs may make Dexterity checks to leap into the stairwell, but if they fail they fall down the steps, sustaining 3d6 damage.

- The PCs find the goblin’s dining hall (area 32). An examination of the meat hanging there (and the realization that some of it is human) is cause for a horror check. Ten goblins appear, accuse the PCs of stealing their dinner, and a melee ensues.
- The PCs hear a guttural chanting in area 98. There, they find 12 goblins worshipping Arawn in what used to be the dance hall. The goblins have smeared a blue paste all over their bodies and are dancing in a circle around a bound and gagged human, occasionally raking their prisoner with light scratches of their claws.

The human is one of the druids of Forlorn. If the PCs rescue him, he proves too terrified to answer any questions. He only begs to be let go and bolts at the first opportunity.

### Encounters in Multiple Time Periods

A number of monsters roam the corridors of Castle Tristenoira in the time periods of both Castle B and C. Rotting food in unused pantries and kitchens has attracted giant rats. Worgs (which the lord can control at will) run freely in the halls, in packs of 3d4 members. The occasional solitary gremishka lurks under a bed or wardrobe, just waiting for a PC to reach underneath. In the dungeon, a solitary wererat waits until the lord is through feeding on his prisoners, then scurries in to take a bite herself.

All of the creatures summarized below appear in volumes I and II of the *MONSTROUS COMPENDIUM™*, except the gremishka, which appears in the rule book of the *RAVENLOFT® Realm of Terror* boxed set.

**Giant Rats (3d4):** THAC0 20; Dmg 1d3; AC 7; HD 1/2; hp 4; MV 12, Sw 6; SA disease (5% chance per bite—save vs. poison applies); SD nil; MR nil; SZ T; Int semi; AL N(E); ML 6; XP 15 each.

**Worgs (3d4):** THAC0 17; Dmg 2d4; AC 6; HD 3+3; hp 25; MV 18; SA nil; SD nil; MR nil; SZ M; Int low; AL N(E); ML 11; XP 120 each.

**Gremishka:** THAC0 20 (18 vs. targets over 4’ tall); Dmg 1d3; AC 4; HD 1/2; hp 3; MV 12; SA nil; SD +4 bonus to saves vs. attacks with an area of effect; MR nil; SZ T; Int very; AL CE; ML 5; XP 35.

**Lycanthrope, Wererat:** THAC0 17; Dmg by weapon; AC 6; HD 3+1; hp 22; MV 12; SA -2 to opponents’ surprise rolls in ambush situations; SD silver or +1 or better weapon required to hit; MR nil; SZ S-M; Int very; AL LE; ML 12; XP 270.

The DM is encouraged to study the general entry on lycanthropes, as well as the specific section on wererats, before employing that monster in an attack.



## CLUES AND TREASURES

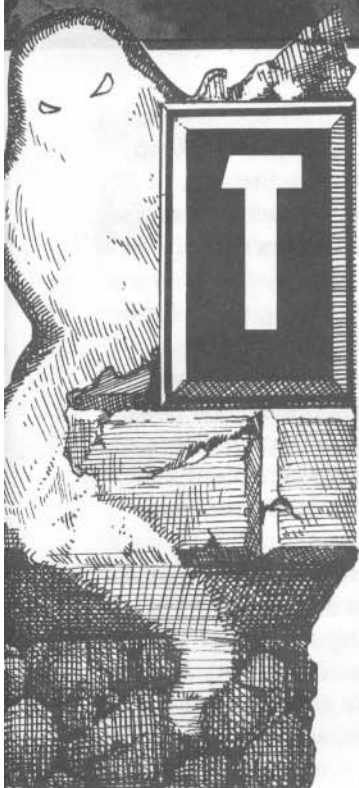

here was the Door to  
which I found no Key;  
There was the Veil  
through which I might  
not see.

—Edward Fitzgerald

Castle Tristenoira contains its share of treasures, but more importantly, the Castles Forlorn contain numerous clues that will help the PCs unravel the history of the lord. A few of these clues (letters, diaries) have already been detailed in the “Major Hauntings” section (pages 8–12). Other clues, detailed in this chapter, can be gained through conversa-

tion with NPCs, ghosts, and haunts.

### Treasures of Castle Tristenoira

**False Treasury (area 152):** The locked chests in this room do contain some real treasure: 3,000 sp; 1,500 gp; 6 rubies (100 gp value each—see below); a necklace (500 gp value); two rings (300 gp value each); and two *potions of healing*. Each type of coin is held in a separate, locked strongbox, the jewelry lies in yet another locked coffer, and the potions are in leather skins, all stored in a wooden box.

However, the chests also contain several traps. An *elixir of madness* lies with the healing potions and bears the same type of label. (The DM should roll 1d4 to determine which is the cursed item.) The gold pieces have been sprinkled with *oil of fumbling*. One of the six rubies (roll 1d6 to determine which) is a *peript of foul rotting*. One of the two rings is actually a *ring of weakness*. Finally, lying among a pile of small leather sacks in the corner of the room is a *bag of devouring*. See the *DMG* for details on the appearance and effects of each item.

**The Lord’s Treasury (area 163):** 13,000 sp; 6,000 gp, and 17 various gems (average value: 150 gp), all locked in chests. The treasury also contains several magical items, all of them captured from Tristen’s victims: a *ring of mind shielding*, a flask of *oil of fiery burning*, *bagpipes of fog* (these work as a *horn of fog*), a *rod of resurrection*, an *eversmoking bottle*, and a *scroll of protection from undead*.

At any point during the adventure, Tristen may retreat to his treasury to arm himself with any or all of these items. Of course, he can do so only during the day; by night, Tristen is incorporeal and cannot pick up any of these objects, let alone use them.

**The Goblin Treasury (area 67):** This room is filled with items that the goblins consider especially valuable. Piled in an untidy heap on the floor are 10 silver serving trays that have been crudely fitted with handles for use as shields (worth approximately 50 sp each if melted down for scrap), bags of marbles (no monetary value), various household ornaments looted from the ruins of Birnam (most chipped or broken—no monetary value), two opals of questionable quality (worth 10 gp each), and several pieces of jewelry—two gold rings, an elaborate brass brooch, a broken silver mirror, three silver shoe buckles, and a string of pearls. The total value of the jewelry is 1,200 gp.

### Optional Treasure

Various treasures can be scattered throughout Castle Tristenoira. The DM should look over the following list, choose a few treasures to add to the evening’s game, and make note of their hiding places. Too much treasure spoils the adventure, so the DM should be selective.

- *Dust of disappearance*, in a small leather pouch, stuffed inside the mounted stag’s head in the foyer (area 5[B or C]).
- A *Murlynd’s spoon*, lying in a pile of rubbish on the floor in the unused kitchen (area 15[C]) of the Lord’s Tower.

## CLUES AND TREASURES

- Hanging from a beam in the stables (area 22) is a 30-foot-long *rope of constriction*. Dangling in a noose, his feet just a few inches off the floor, is a dead townsfolk or goblin.
- Mixed in with the marbles the goblins use as money in the gambling den (area 24) is a *pearl of wisdom*. Alternatively, the pearl can be found, together with a number of opaque marbles, in the sporran of a goblin in this room.
- In one of the goblin chief's rooms (area 31 or 33) can be found a *potion of extra healing* and a *scroll of protection from electricity*. The latter has been used to wipe blood off a sword.
- Morholt has been buried in his tomb (area 34) in his *plate mail of etherealness*. The armor is currently +2 and has 5 charges left. Removing the armor from the body results in a Ravenloft powers check and an encounter with the ghostly Morholt. To learn the command word that enables the wearer of the armor to become ethereal, the PCs must consult a diary in Morholt's bedroom (area 102). The command word is "commutaré."
- Lucy ApMorten has hidden an *amulet of life protection* inside a secret pocket in one of her robes in the guest room (area 71[B/C]). The robe has been slashed apart, but the pocket was missed. Anyone who carefully feels the material will find the amulet.
- Mixed in with a regular deck of cards in the games room (area 72) are two jokers from a *deck of illusions*.
- Sitting beside polishing solutions in a store room (area 77[B]) is a jar that contains *oil of timelessness*.
- A diamond ring (1,000 gp value) has slipped between the cushions of one of the armchairs in the sitting room (area 97[A]). It was lost by one of the visiting townsfolk.
- Hidden inside a false floor in the bottom of the wardrobe in Brangain's bedroom (area 99) is a *necklace of prayer beads*. It has only three "special beads"—two beads of blessing and one bead of curing.
- Inside the locked chest in the captain of the guard's bedroom (area 105[B]) are 250 sp, 100 gp, and a *dagger of throwing*.
- Three *arrows +2* are mixed in with the regular arrows in a quiver in the archers' post (area 112).
- Among the books in the reading room (area 116) is a *manual of bodily health*.
- Inside the sewing room (area 121), mixed in among the other sewing supplies, is a *needle of sewing*. (When wrapped in a torn piece of cloth or leather, this new magical item instantly mends it as if the 1st-level wizard spell *mending* had been cast.)
- Inside the lord's private music room (area 125) is a set of *bagpipes of haunting*. (Treat these as *pipes of haunting*.)
- Inside the locked storage room (area 140) is a suit of *plate mail +2*. This armor, custom made for the 12-year-old Gilan, will only fit characters 4'-4 1/2" tall.
- Among the books in the lord's secret study (area 168) is a *book of vile darkness*. Rather than being attacked by a nighthag, good characters who look inside the book have an 80% chance to be attacked by a *bastellus*. (See the RAVENLOFT® appendix of the MONSTROUS COMPENDIUM™.)
- The lord's secret sitting room (area 171) contains a *decanter of endless water*.

### Mysterious Missives

There are a number of documents to be discovered as the PCs investigate the castle. These will do much to reveal the secrets of Tristen and the domain of Forlorn. The adventuring party should find all of these messages as they explore (provided they search the proper areas, of course).

**Letter from Rivalin ApTosh to Flora ApBlanc**  
Hidden in a locked box inside the lord's storeroom (area 140) is the following letter, dated in the spring of 1594.



## CLUES AND TREASURES

My beloved Flora,

It makes my lifeless heart ache with joy to know the trust you have placed in me, to know you love me still, despite the terrible change that has come over me and the abuses I have subjected you to. When you first discovered the scars on your neck . . .

But let us not dwell on that now. What matters is the life of our unborn child. I beg of you, Flora, please flee the land before harm comes to either of you. I can no longer control my hunger, and I fear that hunters will come for me soon. I do not wish them to find you here with me when they do.

If the child is a girl, name her whatever you please. But if the child is a boy, do not name him after me. He need not be cursed with my name, as well as my blood. Call him something pleasing to the tongue. Tristen, perhaps.

Yours always, and with a prayer for your soul,  
Ribaldu

### Passage from *The Purification of Corrupt Flesh*

This textbook, written in the year 1737 by a cleric of Diancecht, is safely tucked away in the lord's private library (area 135). If the PCs examine the titles on the shelves in that room, the DM should point out this text as the most curious of them all. The following passage catches the PCs' attention.

*It is a well-known fact that holy water burns the flesh of the undead, wounding them grievously and leaving stigmata upon the skin, but few realize its healing properties when taken as a tonic against the predations of these evil creatures.*

*Holy water, in appropriate doses, will infuse the blood with the goodness of the gods. If taken in the first four days after a vampire's bite, it will cleanse the body of the toxins found in vampiric saliva. Unfortunately, if the victim's slide toward death has progressed beyond a certain point, the holy liquid acts as a toxin, killing instead of curing. But the gods do have*

*their mercies; although the life is lost, the soul remains intact and the curse of vampirism is laid to rest.*

*In healthy flesh, holy water acts as a tonic, giving the blood a particular taint that the undead find unpleasant. Although beneficial, this effect is unfortunately short-lived. Another drawback is that only priests seem to have the moral fortitude to absorb the protective properties of holy water into their bloodstreams.*

Although the book is presented as an empirical work, the information is highly speculative. The DM may opt to accept any of the information presented as truth and incorporate appropriate rules into the campaign.

### Inheritance Papers

These forged documents establish Marc ApBlanc's claim to the keep. Both can be found in the lord's bedroom (area 89C). The significant passages are dated 1869 and 1908:

*I, Brangain ApBlanc, now lucid and in good health, do leave my holdings in the land of Gilcutty to my son Sean ApBlanc. In addition, as the sole heir of the landowner known commonly as the Minstrel ApBlanc, I also leave to my son my holdings in that land, to wit, the keep that was constructed in 1809.*

*I, Sean ApBlanc, now lucid and in good health, do leave my property, my holdings in Forfar, to my son Marc ApBlanc.*

### The Clan ApBlanc

This book lists the numerous families, and some of the notable members, of the clan ApBlanc. The dates accompanying the names range from 1502 to 1920. The book is found in the lord's private study (area 138[B/C]).

- Flora ApBlanc, born in 1573 to Lord Keegan and Lady Eileen ApBlanc. Died in 1594. The cause of death is listed as "suffocation."

## CLUES AND TREASURES

- Briony ApFittle, born in 1600, named lady of the land in 1637, when Lord Keegan and Lady Eileen died heirless. Died in 1661.
- Herrold ApKie, born in 1901. No date of death. (This is the goblin leader Herrd.)
- Andrew ApFittle, born in 1894, named lord of the land in 1929, upon the death of Lord Patrick ApFittle. (After Andrew has been executed, Tristen will record the date of his death in this book—1934.)
- Nellie ApFittle, twin of Andrew, born 1894. A subsequent entry notes that Nellie was “lost to the druids” in 1914. (This is an ancestor of Shelaugh the druid.)
- See page 29 regarding a special entry.

### *Terms of Surrender*

These papers, dated 1933, specify the tribute to be paid by the people of Birnam for supporting the ApFittles in their siege against Marc ApBlanc and his mercenary army. They are kept in the accounting room (area 81C).

*The people of Birnam, having agreed to pay reparations in the amount of 10,000 gp (or an equivalent value of goods) furthermore agree that their leader, Andrew ApBlanc, shall be released only upon payment of an additional 5,000 gp (or an equivalent value of goods). Should this reparation fail to be paid by the due date, said leader shall be put to death as befits his current status as a criminal of war.*

### **Cryptic Note**

This note, in Tristen’s handwriting, is rolled up inside a map of the castle in the map room (area 83[B/C]). Several X’s have been drawn in the courtyard; each X is labeled “weed.”

*Regularity of weeds leaves little doubt. Grove still seeking to re-establish itself. Gardeners report mysterious disappearance of one of their members, who was touching tree when a ghost was sighted. Must order them to cease work on days that I slumber.*





## SPECIAL ENCOUNTERS

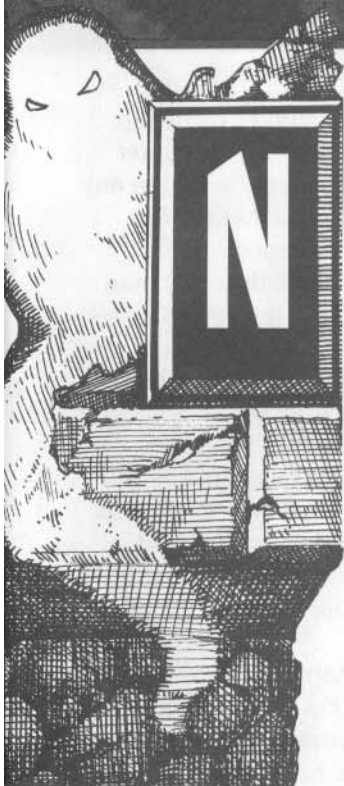

*o longer mourn for me  
when I am dead  
Than you shall hear the  
surlly sullen bell  
Give warning to the  
world, that I am fled  
From this vile world,  
with vilest worms to  
dwell.*

—Shakespeare

In addition to the three time periods in which the castle exists, PCs have a chance to encounter two additional time periods: the year 1594, in which Tristen's parents were killed ("Unholy Night"), and the year 2624 (Barovian calendar 1237), in which Castle

Tristenoira has been utterly destroyed and Tristen has been freed of his curse ("A Dire Warning").

### Death of an Ancestor

**T**here is one special entry in "The Clan ApBlanc" (on pages 27–28). The entry notes the birth of Corey (insert PC's last name) in 1810. Tucked into the page is a letter, praising the minstrel ApBlanc for his part in rescuing the boy's mother the year before. The PC recognizes Corey as a direct ancestor. Had the lord not saved the life of Corey's mother, Corey would not have been conceived and born. As a result, the PC himself or herself thus would never have been born.

This encounter is intended to create a dilemma for the PC. If Tristen is "irrevocably killed" before this event can occur, then the PC could be erased from existence. It doesn't matter that the PC's family never lived in Ravenloft; the demiplane of dread has been around for nearly three centuries, and there's no reason why the PC can't have come from a long line of heroes and adventurers.

If the diary entry is discovered, but the PCs proceed with the "Unholy Night" scenario and destroy Tristen, DMs who enjoy experimenting with temporal paradoxes might exercise the following result: the PC remains in existence, but he or she suddenly recalls a different father. The consequence of this new reality is that the PC must re-roll *all* of his or her attribute scores (Strength, Dexterity, Constitution, Intelligence, Wisdom and Charisma), making any necessary adjustments to abilities and bonuses/penalties. This can be a one-shot, 3d6, "what-you-roll-is-what-you-get" scenario, or the DM may call for any of the methods discussed in the *PHB*.

### Unholy Night

**T**he only way to permanently defeat the lord of Forlorn is to enter the year in which he was born and alter the course of history. This time period, which places the PCs in the year of Tristen's birth, offers that opportunity.

This time period may be entered by chance if the DM rolls a "special" result on the Temporal Shift Table (page 3), but it also can be entered deliberately if the PCs have experienced the suggested encounter with Flora, explained on page 12 of this booklet.

If the DM rolls a result of 00% on percentile dice when consulting the Temporal Shift Table, it is recommended that the PCs experience the "Dire Warning" scenario first (see page 32) and save "Unholy Night" for the next time that the "Special" result comes up.

Deliberately traveling to 1594 is possible only on one of the four druidic holy days—the equinoxes or solstices. (The DM can mandate that one of those days takes place during the PCs' visit to the castle, or the dice may be used to decide if the opportunity arises at all. A druidic holy day occurs every 91.25 days—roll 1d100 when the PCs enter Forlorn. For accuracy in timekeeping, the DM should pre-plan the number of days until solstice or equinox for each of the three time periods. When the holy day arrives, tiny saplings sprout up across the

## SPECIAL ENCOUNTERS

domain of Forlorn and even within the courtyard of the castle itself. The lord sinks into a deep slumber in one of his sanctuaries, and the goblins are no longer under his control.

The first task the PCs will face will be the preservation of at least one sapling per person out of the 6d4 that sprout in the courtyard. (The goblins will still try to weed the grounds.) Next, the PCs must arrange to be in the courtyard (area 37), or outside the front door (area 9) in the case of Castle A, when the ghostly Flora ends her nightly run. If each PC is touching a sapling at the stroke of 11 pm, they will be transported into this encounter.

After the temporal shift occurs, the PCs find themselves standing in the old sacred grove on the night that Flora met Rual and gave Tristen into the druid's care (see page 8 of *The Weeping Land*). The year is 1594, and it will be 340 years before Tristen's evil reaches such a height that Forfar is wrenched into Ravenloft as the domain of Forlorn.

Somewhere in the forest behind the PCs, the young druid Rual is meditating. Below, the lights of Birnam can be seen. After the PCs get their bearings, read the following player character text.

*Far off in the direction of the village below, you see a group of flickering torches moving in the streets. They surround the largest building in the town. The sound of angry voices floats up to you on the wind.*

*The torches disappear into the building, but then quickly flood back out and flow out of the village in your direction. It will take a few minutes for them to get close to your position, but they seem to be headed this way. As you monitor the approach of the torches, the sounds of a mob rise before them.*

*Suddenly, a lone figure crashes through the trees—it's a young woman with a bundle in her arms, sobbing as she runs. She spots you, and at first she is taken aback. The question is clear on her face—are you part of the mob? Turning, she dashes off into the night.*

If this is only a chance encounter (resulting from the Temporal Shift Table), the encounter ends here. As soon as the PCs take a step in any direction, they are shifted back into the time period they were in before this encounter.

However, if the PCs have found their way here through the ghostly Flora's plea, they stand poised to radically alter the course of history. Having encountered Flora's ghost, they easily recognize the flesh-and-blood Flora now. If they do nothing, she spots Rual (who emerges from the woods behind the PCs), hands her the baby Tristen, and then turns to face the mob. What the PCs do next will influence literally all that comes afterward.

Any number of actions are available to the PCs, each resulting in a different future.

- Some PCs may seek to harm the baby, which may or may not destroy Forlorn, depending on the DM's plans for the domain. Nevertheless, this is an evil act, in spite of the baby's future. The mere mention of such a strategy will result in a Ravenloft powers check (+20% modifier), and any who participate in such an act *automatically* fail a powers check, for they have committed an act of ultimate darkness.

Flora will immediately curse the PCs for their heinous actions, and the manifestation of the curse should be severe. The DM might require the PCs to: save vs. death with a -10 penalty; suffer some form of madness that periodically changes the PCs into NPCs with extremely dangerous habits; or defend themselves from a legion of incensed, high-level druids. See the *Forbidden Lore* boxed set for some excellent ideas for curses and madness. Flora's curse would fall under the "Dangerous" category.

- If the PCs wait until Flora passes the baby to Rual before taking any action, the druid will use her *obscurement* spell to cloak her escape and then her *tree* spell to hide from the PCs. The druid will defend Tristen to the best of her abilities, and she'll refuse to believe any story about the Shadow Plane.



## SPECIAL ENCOUNTERS

Meanwhile, the mob will lynch Flora. If Rual survives the encounter, she can spread the word of the PCs' evil action among her fellow druids, who then become enemies of the PCs and seek revenge.

- If the PCs kill Rual before Flora arrives, there is no one to hand her child to. The mob catches up to Flora, and attempts to kill both Flora and her child. The PCs should intervene, but if the baby survives, then he will still grow up to be a monster, and the prevailing tides of time will eventually, somehow, put Forfar back on the road to Ravenloft. The PCs must still deal with this.
- If the PCs defend Flora against the mob, they can easily turn the tide—the townspeople are all 0-level humans with pitchforks, clubs, and other weapons with which they are not proficient. There will be several dozen in the mob, but the death of one or two of them (or any show of force) will scatter them to the winds. Flora then insists upon Tristen being turned over to Rual, to be raised by the druids.

If the PCs agree, history is altered only slightly; Flora escapes the land, but returns when Tristen is 15 (the year 1609). Instead of just killing Rual, Tristen kills both the druid *and* his mother in the sacred grove. History progresses as it did before, and the land enters Ravenloft. (As soon as the PCs place the child in Rual's arms, they are transported to Castle Tristenoira, to the time period they were exploring before this encounter occurred.)

Ideally, the PCs can prevent history from repeating itself by refusing to allow the child to be raised by the druids and instead escorting Flora and her child safely out of the country. Once they do so, the Mist will swell up and sweep them off to the destination of the DM's choice. Alternatively, they may agree to raise the child themselves. Tristen will readily train in any class the PCs choose—until he reaches the age of 15. . . .

**Flora (P1):** THAC0 20; #AT 2 (fists); Dmg 1d2/1d2; AC 10; hp 4; MV 12; ML 19; AL NG; XP 25. S 8, D 11, C 10, I 12, W 14, Ch 15.  
Personality: Panic-stricken  
Spell: *Entangle*

Flora is listed as a priest because of her association with the druids. Were she not of noble birth, she might well have entered the order, but her parents would not have it.

**Rual (P5—druid):** THAC0 18; #AT 1 (dagger [sacred deer antler]); Dmg 1d4; AC 9; hp 22; MV 12; ML 13; AL N; XP 300. S 12, D 15, C 17, I 13, W 15, Ch 15.  
Personality: Reserved, just.

Spells (5/4/1): *Animal friendship, cure light wounds, entangle, faerie fire, shillelagh; barkskin, charm person or mammal, heat metal, obscurement; tree.*

Innate spells, due to red hair (Rual's hair is a reddish brown, affording two 1st-level spells): *Analyze balance, pass without trace.*

**Mob Members (25):** THAC0 20; Dmg 1d6 (club or pitchfork); AC 10; HD less than 1/2; hp 2 each; MV 12; SA nil; SD nil; MR nil; SZ M; Int avg; AL CN; ML 8; XP 15 each.



## SPECIAL ENCOUNTERS

### A Dire Warning

**T**his encounter projects the PCs forward in time, to a period when Tristen has broken free of his curse and escaped the confines of Forlorn. The scenario is designed as a means by which the DM can warn PCs against aiding Tristen in this endeavor. If they agree to help the dark lord defeat the druids or expose the location of Sanctuary, and especially if the PCs begin to destroy the sacred oak tree in the courtyard on a druidic holy day (see “The Sacred Oak,” on page 21 of *The Weeping Land*), then a temporal shift will automatically occur and sweep the PCs into the distant future.

Alternatively, it can simply be used to frighten characters and add tension and mystery to the game. If a roll of 00% on the percentile dice occurs when consulting the Temporal Shift Table (on page 3), the PCs can be sent to this encounter.

When the player characters enter this time period, they do so as corpses who have been dead for centuries! Killed long ago by the lord and his minions, they are now the objects of a druid’s *speak with dead* spell.

At first, the PCs should simply think they have experienced yet another temporal shift. This time, however, they find themselves walking in the ruins of what once was Castle Tristenoira. They stand amidst tumbled masonry and an overgrown courtyard; only a few ragged pieces of castle wall remain. The sky overhead is ominously dark, lightning crackles in the distance, and a heavy rain falls.

In a few moments, the PCs notice two things. The first is that they appear to be normal (all equipment and clothing intact), yet they soon find they are insubstantial ghosts. After a moment of confusion, they see the second thing: their own twisted, skeletal remains at their feet, at which point they should realize they are dead.

Depending upon which time period they were exploring prior to this encounter, the PCs will have been dead for varying amounts of time. If they just stepped from Castle A, they have been dead for 785 years; if from Castle B, their corpses have lain

here for 690 years; and if from Castle C, they’ve been here for 502 years.

The sight of their bodies and realization that they are dead is suitable cause for a horror check. Those still in possession of their faculties see and hear the following:

*A bedraggled-looking figure steps from behind the remains of a wall. Dressed in a plain brown kilt and sodden cloak, the man is barefoot and gaunt. His long, unkempt red hair reveals him to be a druid of Forlorn. He points a bony finger and speaks.*

*“You! You are the cause of what you see here! The castle is in ruins and the evil lord is free. For centuries his curse held him, but you meddled in things you did not understand.*

*“I am the last of my order—the only one who keeps alive the worship of Belenus and Daghdha. But one man alone cannot restore the balance of the land. No, the scale is tipped, and evil now completely outweighs the good.*

*There is only one hope of setting things right. They say that, in this part of the land, time bends and twists upon itself in strange and mysterious ways. If you spirits of the dead can turn back time, then I beg, nay, demand that you undo what you have done!”*

If the PCs have arrived in this time period by chance, this vision of the future ends here. The PCs return to the time period they were exploring before this temporal shift.

If the encounter is being run as a warning, however, the druid describes how the course of action the PCs took resulted in tragedy. If they agreed to help Tristen defeat the druids, the NPC tells a sad story of how they were hunted down. If the PCs told Tristen where to find Sanctuary, the NPC bemoans the betrayal of strangers. If they were about to chop down the sacred oak, then the druid tells its story and how its destruction set Tristen free.

The PCs are then transported back to their previous time period and must undo the damage they may have already perpetrated.





1088XXX1903

ADVANCED DUNGEONS & DRAGONS, AD&D, and RAVENLOFT are registered trademarks owned by TSR, Inc.  
The TSR logo is a trademark owned by TSR, Inc. ©1993 TSR, Inc. All Rights Reserved. Printed in the U.S.A.

# Ravenloft<sup>®</sup>

Boxed Adventure Set



## Melancholy Meetings

Adventure Book





# MELANCHOLY MEETINGS

## Table of Contents

Introduction .....	2	Shattered Secrets .....	18
What's Needed to Play .....	2	Music of the Mists .....	25
Encounter Organization .....	2	A Bitter Harvest .....	30
Trail of Tears .....	3	Maps:	
Still Waters .....	6	Caverns of the Dead .....	10
Caverns of the Dead .....	9	Sanctuary .....	22
Howling Vengeance .....	15	Forlorn .....	32

## Credits

Designer: Lisa Smedman  
Editor: David Wise  
Project Coordinator: Dori Jean Watry  
Graphics Coordinator: Sarah Feggestad  
Art Coordinator: Peggy Cooper  
Poster Artist: Robh Ruppel  
Box Cover Artist: Dana M. Knutson  
Booklet Cover Artist: Stephen Fabian  
Interior Artists: Stephen Fabian, Arnie Swekel, and Robert Klasnich  
Typography: Angelika Lokotz  
Cartography: David C. Sutherland III and Cynthia Felegy

ADVANCED DUNGEONS & DRAGONS, AD&D, and RAVENLOFT are registered trademarks owned by TSR, Inc. MONSTROUS COMPENDIUM, DUNGEON MASTER, DM, and the TSR logo are trademarks owned by TSR, Inc. All characters, character names, and the distinctive likenesses thereof are trademarks owned by TSR, Inc. ©1993 TSR, Inc. All Rights Reserved.

Random House and its affiliate companies have worldwide distribution rights in the book trade for English-language products of TSR, Inc. Distributed to the toy and hobby trade by regional distributors. Distributed to the book and hobby trade in the United Kingdom by TSR Ltd. This material is protected under the copyright laws of the United States of America. Any reproduction or unauthorized use of the material contained herein is prohibited without the express written consent of TSR, Inc.

TSR, Inc.  
POB 756  
Lake Geneva  
WI 53147  
U.S.A.



TSR Ltd.  
120 Church End  
Cherry Hinton  
Cambridge CB1 3LB  
United Kingdom

# INTRODUCTION



*It was black,  
In heaven no single star, on earth  
no track;  
A brooding hush without a stir or  
note,  
The air so thick it clotted in my  
throat;  
And thus for hours; then some  
enormous things  
Swooped past with savage cries  
and clanking wings.*

—James Thomson

Forlorn is a dreary yet dangerous place, a land of secrets and whispers. Visitors can expect to find no safe rest, no respite from the terrible creatures that plague

this land. The skies are perpetually overcast and the land is damp with rain. By night, sheet lightning illuminates the sky in ghastly colors. Even if the intrepid adventurers who come to explore Forlorn know that the lord of this domain is forever trapped within his strange castle, they should take small comfort from it. Servants of Tristen ApBlanc roam freely, and the land itself is horribly twisted.

The encounters in this book are designed to offer an introduction to Forlorn and provide clues about both its lord and his home. Challenges are tailored to a group of four to six player characters (PCs) at the 4th to 6th level of experience. Before beginning any of these encounters, the Dungeon Master (DM) should first read *The Weeping Land*, the accompanying source book.

*Melancholy Meetings* is intended to be used before the castle adventure book, *Eve of Sorrows*, but it's not necessary for the PCs to experience all of the encounters in this book before embarking upon the next. Indeed, DMs may save some of the short adventures in this book in order to liven up the PCs' departure from Forlorn (assuming they live to escape!), but many of the encounters contained herein include important clues and treasures that will help the PCs succeed in the main adventure.

## What's Needed to Play

Aside from the *DUNGEON MASTER™ Guide* (DMG) and the *Player's Handbook* (PHB), it's assumed that the DM owns a copy of the *RAVENLOFT® Realm of Terror* boxed set (1053) as well as the corresponding appendix of the *MONSTROUS COMPENDIUM™* (2122). The *Forbidden Lore* boxed set (1079) is also considered part of the core rules system and will come in handy for those DMs who might like to role-play a Vistani fortunetelling, but it is not essential to running the *Castles Forlorn* boxed set. *Van Richten's Guide to Ghosts* (9355) is highly recommended reading for DMs who want to fill their adventures with interesting and frightening ghosts, but it too is not required.

The following monsters can be encountered if every adventure in this book is played: Aggie\*, broken one\*\*, death's head tree\*, eel (electric)†, fungus (phycomid)†, geist†, goblin\*\*, golem (bone)\*\*, gremishka††, leech (throat)†, mist horror\*\*, odem††, treant (undead)\*\*, worg†, zombie wolf\*.

\* *The Weeping Land* source book

\*\* RAVENLOFT MONSTROUS COMPENDIUM

† MONSTROUS COMPENDIUM, vols. I and II

†† RAVENLOFT *Realm of Terror* boxed set

## Encounter Organization

Each individual encounter begins with a brief summary for the DM. Key points of the encounter are also noted here so the DM will be aware of and prepared for them. The summary is followed by a background section and then a setup for the actual encounter.

Following each encounter is a section called "Complications," which is a list of options for making the encounter a bit tougher for larger, higher-level, or extra-strong parties. The DM is welcome to use any or all of the suggestions, or to adjust them for any adventuring party's strengths and weaknesses. Finally, each encounter contains a "Resolution," which ties up loose ends and instructs the DM on how to proceed (if necessary).



## TRAIL OF TEARS



*eyes of Fire  
Glared at me throbbing  
with a starved  
desire;  
The hoarse and heavy  
and carnivorous  
breath  
Was hot upon me from  
deep jaws of death;  
Sharp claws, swift  
talons, fleshless  
fingers cold  
Plucked at me from the  
bushes, tired to hold.*  
—James Thomson

The PCs meet the goblins of Forlorn in this adventure, which is an ideal first encounter. The party is called upon to rescue or protect members of a lone Vistani caravan that is attacked by the goblins. (For full details about the Vistani, Ravenloft's wandering gypsies, see the RAVENLOFT® *Realm of Terror* boxed set.) In the process, the PCs may learn that redheads are a particular target in Forlorn, and they may even witness the innate abilities of one of them.

The DM will want to take note of Petar's innate abilities (see "Spellcasting Abilities of Redheads" on page 44 of *The Weeping Land* for more information) and the dagger-sized *hornblade +1* that he carries.

### Background

**P**etar is the son of a Vistani woman and a *giorgio* (a nongypsy). Both of his parents died when he was just a babe. Since then he has lived with the Vistani Madame Ursula, his maternal grandmother. She is the only mother Petar has ever known. He calls her Oma.

Because of the boy's freakish appearance—most gypsies have raven-black hair, and Petar's is red—these two live on the fringes of Vistani society, usually traveling

alone in their vardo. They make their living through Ursula's highly accurate fortunetelling. Ursula often worries about what will happen to Petar when she is dead and gone. Neither of them realizes that Petar's father was of druidic stock, although Ursula remembers that Petar's paternal grandmother came from Forlorn.

Petar carries a dagger carved from a single piece of stag antler. The weapon belonged to his father. Petar doesn't realize that it is a *hornblade +1*, fashioned by the druids of Forlorn. The *hornblade*, a seemingly low-level magical item, may be either overlooked or underestimated by the PCs, but the weapon is made from a stag antler consecrated to the god Daghda, and it would prove a powerful tool in the fight against Tristen (see page 20 of *The Weeping Land*).

Ever since he entered the domain of Forlorn, Petar has "felt peculiar." In fact, he is on the verge of discovering his innate spell abilities.

### Setup

**I**f the PCs are newcomers to Ravenloft, they step out of the Mists and into the heart of the blighted forest (point A on the map of Forlorn, on page 32). Just ahead, moving slowly along a faint trail, is a colorfully painted, enclosed wagon drawn by two mules. An elderly woman whose black hair is streaked with white drives the wagon while a boy in his mid-teens walks beside it. The boy's hair is a brilliant shade of red. He glances fearfully about him and holds an unusual-looking weapon in his hand.

If the PCs are entering Forlorn from another Ravenloft domain, the Vistani can be their guides. (Otherwise, the encounter begins as above.) Arriving in Forlorn through the Mists, the Vistani pause and whisper to one another, attempting to establish where they have come. To questioning PCs they will insist that the Mists are playing tricks on them.

# TRAIL OF TEARS

## Goblin Attack

**W**hen the PCs arrive in Forlorn, it is twilight and Madame Ursula wants to set up camp and prepare against the night. The party feels unseen eyes upon them and, with a successful Intelligence check, they note strange rustling in the underbrush. Investigation reveals nothing.

An eerie silence descends upon the forest. Everything is still, as if the infested woodland was holding its breath. Then, the howl of a lone wolf splits the night.

As if in answer, the bushes around you begin to rustle and part, giving way to ugly, misshapen humanoids. There are over a dozen of the strange monsters, curiously dressed in the tattered remains of tartan kilts. In the dim light, it's barely possible to make out their bloated heads, pointed ears, and gaping, fang-filled mouths. Their eyes, which glow like blood-red coals, gleam in the dim light.

The goblins are under standing orders from Tristen to capture all redheads in the domain, so about half of them concentrate their attack on Petar, who fights furiously to defend himself. The rest divide their attacks between Madame Ursula and the PCs, especially if any of them have red hair. All redheads will be attacked in an attempt to *overbear*, rather than injure (see the *DMG*). If and when Petar is overborne, the goblins will use one round to tie him up and then two of them will attempt to flee with him while the rest run interference. If the two goblins carrying Petar escape, the rest flee.

During the battle, Petar's innate spellcasting abilities will kick in, and he will use them to defend himself. Ursula will avoid the goblins by using her *ring of blinking*, and she will fight with a dagger to defend her grandson.

**Madame Ursula (T1):** THAC0 20; Dmg 1d4 (dagger); AC 9 (Dex bonus); hp 6; MV 9 (age); ML 11 (7 if Petar is lost); AL N.  
S 7, D 15, C 7, I 13, W 10, Ch 10.  
Personality: Reserved, protective of Petar.

**Petar (F1):** THAC0 20 (19 with *hornblade*); Dmg 1d4 +1; AC 8 (Dex bonus); hp 8; MV 12; ML 10; AL N.  
S 10, D 16, C 9, I 12, W 8, Ch 14.  
Personality: Shy, fearful.  
Innate Spells: (1st) *Entangle*, *faerie fire*, *invisibility to animals*; (2nd) *produce flame*.

**Goblins (16):** THAC0 13; #AT 2 or 1; Dmg 1d6/1d6 (claw/claw) or 2d6 (bite); AC 4; HD 4+4; hp 22 each; MV 12; SA -2 to opponents' surprise rolls (-4 if opponent meets goblin unexpectedly), face bite (victim save vs. spell to avoid 1d4/round additional, suffocation damage—witnesses make horror checks); SD nil; MR 10%; SZ M; Int low; AL NE; ML 20; XP 975 each.

If a goblin "feasts" (bites an adversary in the face—see page 33 of *The Weeping Land*), PCs may be called upon to make horror checks.

## Complications

- 2d4 goblins are riding worgs and are armed with spears. The goblins and the worgs attack at once, each worg biting while its goblin rider lunges with a spear. Even if the goblin is unseated or killed, the worg (an intelligent creature) continues to fight.

**Worgs (2d4):** THAC0 17; Dmg 2d4 (bite); AC 7; HD 3+3; hp 18 each; MV 18; SA nil; SD nil; MR nil; SZ M; Int low; AL NE; ML 11; XP 120 each.

- One of the goblins has imbibed a *potion of speed* and wields a *spear +1*.
- The goblins have a *net of entrapment*.



# TRAIL OF TEARS

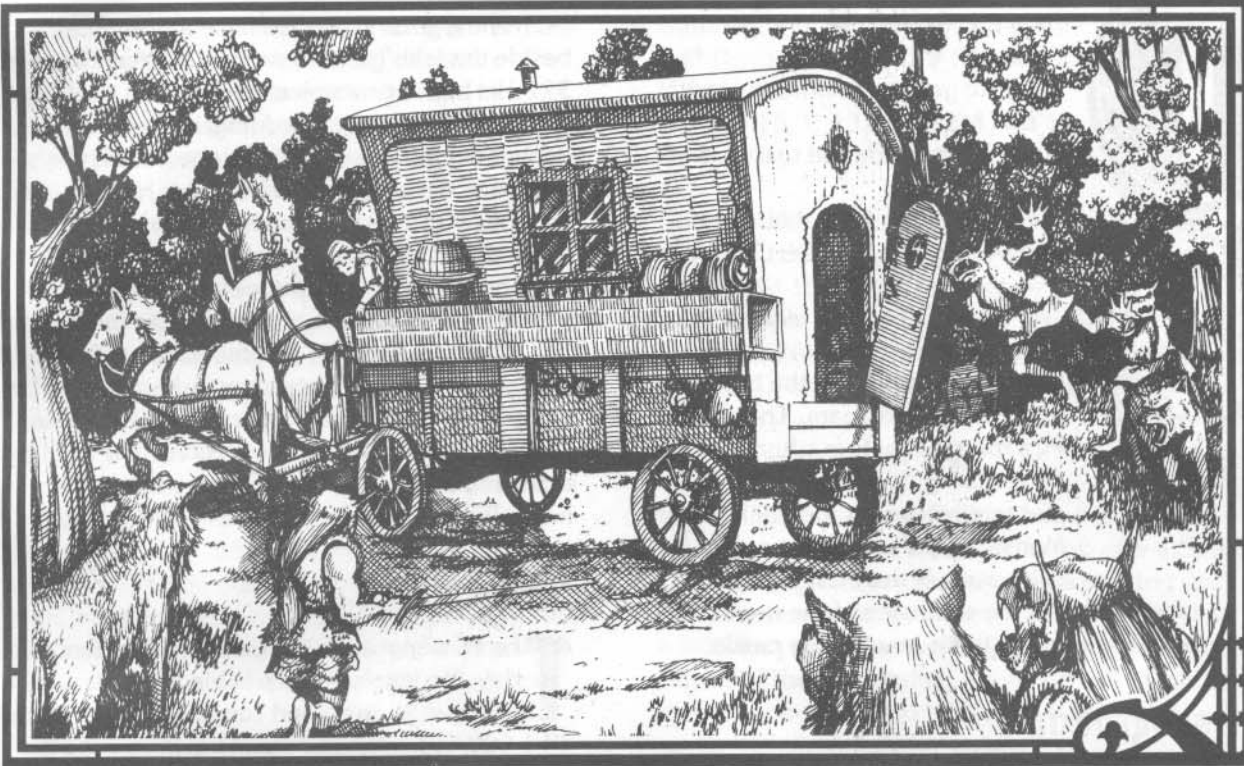

## Resolution

If Petar is captured, the goblins will take him straight to Tristen, who will imprison him in the castle dungeons. Madame Ursula will beg the PCs to rescue him. This can be used as a means of sending the PCs toward Castle Tristenoira (if they haven't already gone there).

If the PCs fend off the goblins, Madame Ursula will declare them "friends of the Vistani." To mark them as such, she will offer to pierce each PC's left ear with two heavy gold rings (worth 25 gp apiece). Giorgios so marked will not necessarily be welcomed into Vistani camps, but neither will they be cheated or robbed by the wandering gypsies.

In any case, Ursula offers to "throw the bones" (foretell the future with dikesha—see the *Forbidden Lore* boxed set) for the PCs. She should make a maximum of three predictions. Here are some sample prognostications (roll 1d6 or choose):

- 1) Beware the beast beloved of the priest.
- 2) The brave shall waltz the gauntlet and win freedom for all.
- 3) 'Tis better to join the Hunt than to be its prey.
- 4) There is little rest in Sanctuary.
- 5) More is seen by monsters than even they know.
- 6) Your fate lies in the castles three.

Ursula now knows that they are in Forlorn. After the fortunetelling, Ursula insists that she (and Petar) must immediately leave the domain, for the monsters hate people with red hair (she doesn't know why). If they have promised to be the PCs' guides, Ursula claims that the Fates have guided them to this place and her powers to negotiate the Mists cannot overcome the Fates. She offers to draw a map of the area. Allow the PCs to see the poster map of Forlorn.

## STILL WATERS



**T**he grey sea and the long black  
land;  
And the yellow half-moon large  
and low;  
And the startled little waves that  
leap  
In fiery ringlets from their sleep.  
—Robert Browning

The PCs meet a mad cleric named Svendar. He asks them to recover his holy symbol from the bottom of the Lake of Red Tears. There, the PCs meet a creature whom Svendar calls Aggie, a dragonlike monster reminiscent of the Loch Ness Monster. This encounter can be used early in the PCs' adventure,

to inform them of the existence of the druids and to hint at what they might meet in the castle.

### Background

**S**vendar is a cleric of Bragi, the Norse god of poetry and song. Two years ago, Svendar and four fellow adventurers blundered into the Mists and emerged in Forlorn. They met their match in Tristen while exploring Castle Tristennoira, and all but Svendar died grisly deaths.

Svendar escaped the castle, but the horrors he experienced drove him mad. He met Tristen in both his forms, and Svendar found his powers were virtually useless. Convinced that Bragi had forsaken him, the priest cast his holy symbol—a golden harp with strings of spun steel—into the Lake of Red Tears.

The priest soon regretted his action, for he could not cast spells without his holy symbol. Now, Svendar is trying to befriend Aggie in the hope of getting her to retrieve the symbol for him. To this end, he catches a full net of electric eels each day, then carves them up and serves them to the monster by tossing them back into the lake. The priest doesn't realize that Aggie prefers live prey and is ignoring his overtures. Svendar himself eats weeds and grubs.

Svendar lives in a small cave in the cliffs beside the lake (point B on the DM map on page 32). His home contains a few battered cooking utensils, some ragged bedding, and a badly dented helm that belonged to one of Svendar's companions, a fighter named Elsa. Holes in the face plate and back of the helm mark the entry and exit points of Elsa's own sword—the lord used his ability to *dominate victims* and forced Elsa to kill herself. (Svendar will describe her sudden, baffling suicide in graphic detail, with tears in his eyes and a mad expression on his face.) The helm is a *helm of X-ray vision* (it has the same properties as a *ring of X-ray vision*). The magic is activated by looking through the visor of the helm. With the face plate up, vision is normal.

### Setup

**T**he PCs approach the Lake of Red Tears. By day, the lake's surface is black, but it turns a fiery red at dawn and sunset, as light reflects off 1,000-foot-high red granite cliffs around it.

A lone figure with long white hair, ragged clothing, and tarnished chain mail emerges from the brush a few hundred feet away and stands by the side of the lake. He begins to haul in a net that holds a huge, wriggling eel. He screams aloud as sparks leap from the eel to his bare, wet hands, but he holds on.

Methodically, he clubs the eel to death, then stoops and carefully slices it into sections as if preparing it for dinner. But instead of cooking the eel, he tosses the chunks back into the lake, crying, "Come and get it, Aggie!"

Svendar knows a bit about Forlorn, but he's completely mad, so his statements are terribly disjointed. If PCs ask him to clarify a statement, he utters unrelated comments. If asked about the specific subjects mentioned below, he will answer as shown. DMs are encouraged to expand upon these statements with nonsense remarks. Tease the PCs with buzz words that will alarm them.



# STILL WATERS

**Himself:** "Bragi used to like me. I served him well, but he's not here. If I can just get my music back and go home, everything will be all right again." ("Home" is called Vinlandia.)

**The Lake of Red Tears:** "It's full of treasure, you know! You only have to reach in and take it. But if you swallow them, you'll die."

**Aggie:** "A friendlier creature you couldn't imagine. I was inside her once. Swallowed whole. She's going to help me find my music."

**The Castle:** "Spirits of the air! Foul undead mist! He's closed the doors on the gods—even Bragi couldn't enter. Walls mean nothing to them, you know. They go right through."

**The Lord:** "I met him before he died, and he was a lot nicer before than after, let me tell you. So's his wife. Dead, that is. Just like Elsa. I wish *she'd* rise up. *She'd* know what to do."

**The Goblins:** "Filthy creatures. The castle's full of them. But only at certain times. They burned my lakeweed. What's a fellow to eat? They like the little trees best. The quick-growing ones. They burn those."

**The Druids:** "The redheaded folk are confused. They pray to trees. They still think the gods are alive. They're always hunting."

**The Maw of Arawn:** "The mountain's where I'm headed next. It's the only way out. The only mist you can trust is the yellow kind."

**His "Music":** (Shamefully) "I threw it in the lake. I thought Bragi had forsaken me, but I was wrong! Without my music, I dare not face him. Please help me find it! *Please! PLEASE!*"

## Lament of the Dead

Svendar can flawlessly recite any song he has ever heard. Although he normally speaks nonsense, Svendar is still able to give a perfect recitation of *Lament of the Dead*, which he learned from the druids. The song is based on the doomed courtship of Rivalin and Flora, Tristen's parents. Svendar will offer to entertain the PCs with the song, which he "learned from the tree priests who live in the green forests." (If the PCs leave before he sings it, they can hear it later from a druid.)

### *Lament of the Dead*

*From oldentyme this mournful rhyme  
Doth echo in my ears;  
I tell it true, this tale of two  
Who should have loved for years.*

*For she was fair as light and air,  
And he was strong and dark.  
She to the throne was next in line;  
He, too, had made his mark.*

*He went away one fateful day  
To fight on foreign land;  
And there he fell, 'mid battle's knell  
No more to claim his lady's hand.*

*And then one night by lantern light  
They saw him in the town;  
His face, they say, was gray as clay,  
And in his hands lay a bloody gown.*

*Men from town did track him down,  
And staked the villain's heart;  
And when they brought him into town,  
His woman wept upon his cart.*

*And then her skin grew pale and thin,  
Her eyes shone wild and bright.  
Her blood-thirst grew; the hunters knew,  
She must be killed that very night.*

*The deed was done on sacred soil,  
Much to the town's great shame.  
Its keepers fled, the grove, soon dead,  
Was then consumed by vengeful flame.*

*The townsfolk cry, and from the sky,  
Come tears of bloody red;  
They stain the very rocks themselves,  
These tears of the undead.*

*So listen well, to this tale I tell,  
Let love not blind your sight.  
When undead call, avoid the fall;  
Stay pure, my friends, stay bright!*

## STILL WATERS

### Aggie Attacks

If the PCs agree to recover Svendar's harp, they are attacked by Aggie. If they're lucky (30% chance per hour), they'll catch a glimpse of Aggie breaking the surface near the center of the lake, and they'll have some idea of what they're up against. Otherwise, Aggie attacks without warning if the PCs remain within ten feet of the shoreline for more than three rounds.

Aggie doesn't attack Svendar, for in recent months he has inadvertently lured fresh "meat" to the lake shore (such as the PCs and hunting goblins). During the attack, Svendar screams and pleads with his "friend" to leave the PCs alone.

**Aggie:** THAC0 7; Dmg 3d8 (bite); AC -3; HD 13; hp 81; MV Sw 24; SA breath weapon (1/2 rounds—functions as a *cloudkill* spell, four-round duration), cause *fear* (as the spell—13th level); SD +1 or better weapon to hit; MR 20%; SZ G; Int very; AL CE; ML 16; XP 11,000.

**Svendar (P7):** THAC0 16; Dmg 1d6 (club); AC 5 (chain mail); hp 41; MV 12; SA nil; SD nil; MR nil; SZ M; AL NG; ML 10.  
S 13, D 11, C 12, I 11, W 14, Ch 13.  
Personality: Insane, flighty.  
Spells: None without holy symbol.

### Complications

- If the PCs battle Aggie in the water, 1d3 electric eels join the battle.

**Eel, Electric (1d3):** THAC0 16; Dmg 1d3 (bite); AC 9; HD 2; hp 15, 13, 9; SA electrical shock (1/hour—3d8 damage within 5', 2d8 within 10', 1d8 within 15'); SD immune to electrical attacks; MR nil; SZ L; Int non; AL nil; ML 7; XP 65 each.

- In battle underwater, there is a 10% chance per round that a PC may swallow (or inhale) a mouthful of water containing a throat leech (roll separately for each PC). Once a throat leech is ingested, it hits automatically. A PC

with a *medallion of adaptation* will not choke, but will sustain blood-loss damage. (Svendar knows how to kill throat leeches—see the *MONSTROUS COMPENDIUM™*.)

**Leech, Throat:** THAC0 special (see above); Dmg 1d3; AC 10; HD less than ½; hp 1; SA choke (50% chance to suffer an additional 1d4 damage—three successive rounds of choking results in death); SD nil; MR nil; SZ T; Int non; AL nil; ML 6; XP 35.

- If the PCs are on shore when Aggie attacks, the PCs are attacked by 2d4 zombie wolves.

**Zombie Wolves (2d4):** THAC0 19; Dmg 1d4+1; AC 6; HD 2+2; hp 10 each; SA nil; SD immune to *sleep*, *hold*, and *charm* spells, death magic, poison, and cold-based spells; MR nil; SZ S; Int non; AL N; ML nil; XP 120 each. Note: Zombie wolves suffer 2d4 damage from successful attacks with holy water.

### Resolution

Svendar wants only to return to Vinlandia. He believes that he may re-enter his world through the Maw of Arawn. He equates the yellow vapors that billow from this mountain fissure with the mists that transported him to Ravenloft. If and when he gets his harp back, Svendar heads straight for the Maw, regardless of the PCs' actions. If the PCs follow, see "Music of the Mists," page 25.

The harp lies at the bottom of the lake, which is 800 feet deep, buried in the mud. The strings are rusted away, but the body is intact. Unless the PCs have some magical means of locating it, there is only a 5% chance per day (non-cumulative) to find the harp.

If the harp is restrung, Svendar can begin using spells (DMs should give him a range of spells appropriate to his level and god), but he is 75% likely to garble his casting, causing the spell to reverse (e.g., *cure light wounds* becomes *cause light wounds*) or fizzle out.



## CAVERNS OF THE DEAD



*nd by and by a dumb  
dead corpse we saw,  
Heavy and cold, the  
shape of Death  
aright,*

*That daunts all earthly  
creatures to his law:  
Against whose force it  
is in vain to fight.*

—Thomas Sackville

An odem attempts to possess a member of the party. The PCs explore the Caverns of the Dead, in which the goblins of Forlorn lay their dead. The PCs

are then briefly captured by goblins. They are aided in their escape by Herrd of Clan ApKie, a goblin leader who hopes to challenge Tristen and wrest control of the lord's goblin minions away from him.

This encounter is used if the PCs approach the Maw of Arawn. They may have chosen to follow Svendar there, since he believes that a portal out of Ravenloft exists in the Maw. He will lead them enthusiastically, jabbering about the wonderful hospitality he'll show them when they get home.

### Background

**T**he Caverns of the Dead (point C on the DM map on page 32) are natural limestone caves that were used by evil clerics of Arawn, Celtic god of the dead, long before Forfar entered Ravenloft. In this secret place of worship, the clerics consecrated a salt-water pool and called it a portal to the underworld plane of their god.

In the current time period the caverns are used by the goblins, to lay out their dead. There is no portal to the Prime Material in the caverns—Svendar has manufactured the idea out of false hopes.

### Setup

Read the following player text when the PCs are exploring near the Maw of Arawn.

Ahead, lying on the damp ground, you see the corpses of two humanoid creatures surrounded by broken weapons. The creatures lie with their claws in each other's throats—it looks as if they were fighting one another.

One more monster is nearby, and still on its feet. It cavorts like a madman, dancing and cackling. Picking up a rock, it begins to pound its own head until blood flows freely across its mangy scalp.

Suddenly, the creature spots you. It drops the rock and beckons you closer with a snarl.

The goblin has been possessed by an odem and it is actually trying to get the PCs to attack it. The odem has forced the goblin to pick a fight with his fellows and, with the arrival of the PCs, it is ready for more violence.

As soon as the goblin is killed, the odem will slip from the corpse and attempt to inhabit one of the PCs. Be prepared to insert the name of one of the PCs into the following player text.

The creature's head lolls to the side as its life comes to an end. Its wide, fanged mouth opens limply and a whitish gas billows out. The smoke hangs in the air for a moment and then moves onto (the nearest PC) and funnels into his/her nostrils and ears!

Instruct the inhabited PC to make a saving throw vs. spell. If he succeeds, the odem flows out of his body and proceeds to the next PC. Continue until a PC fails his saving throw. If none of them fails, the odem will possess Svendar if he is present (no saving throw). If no possession is possible, proceed to "the Caverns" below. When one of the PCs fails the saving throw, tell him that there is a presence inside of him. It will not

# CAVERNS OF THE DEAD

speak to the character or perform any other action at this time. Let the PC sweat over it.

**Odem:** THAC0, #AT, Dmg, AC, HD, hp, and SZ are all of the creature possessed; SA possession; SD immune to physical attacks; MR forced from possessed body only by *wish* or *magic jar*; Int very; AL CE; ML n/a; XP 1,000.

The odem feeds upon strong, negative emotions. It will withdraw from the host PC, sated, after he inflicts 50 points of combat damage. *This should not be explained to the player.*

## The Caverns

**T**he Caverns of the Dead lie close by the above scene. If Svendar is present, he spots the entrance and insists that it leads to the portal to his home plane. Otherwise, the PCs spot it about 25 feet from their present location.

At any time, 3d4 goblins can be encountered in the various caverns—the DM should determine when to introduce them. If alerted to the PCs' presence by noise, the goblins attack immediately, using any of the tactics listed below:

- Attempt to drive the intruders into the Stone Forest (Area 3) and attack when they get stuck there.
- Attempt to drive the intruders into Area 3A and hope they fall into the crevasse.
- Attempt to drive the intruders into the Steam Room (Area 7), where the geyser will erupt and burn them.
- Ambush them from behind the clustered stalagmites (Area 6).

**Goblins (16):** THAC0 13; #AT 2 or 1; Dmg 1d6/1d6 (claw/claw) or 2d6 (bite); AC 4; HD 4+4; hp 22 each; MV 12; SA -2 to opponents' surprise rolls (-4 if opponent meets goblin unexpectedly), face bite (victim save vs. spell to avoid 1d4/round additional, suffocation damage

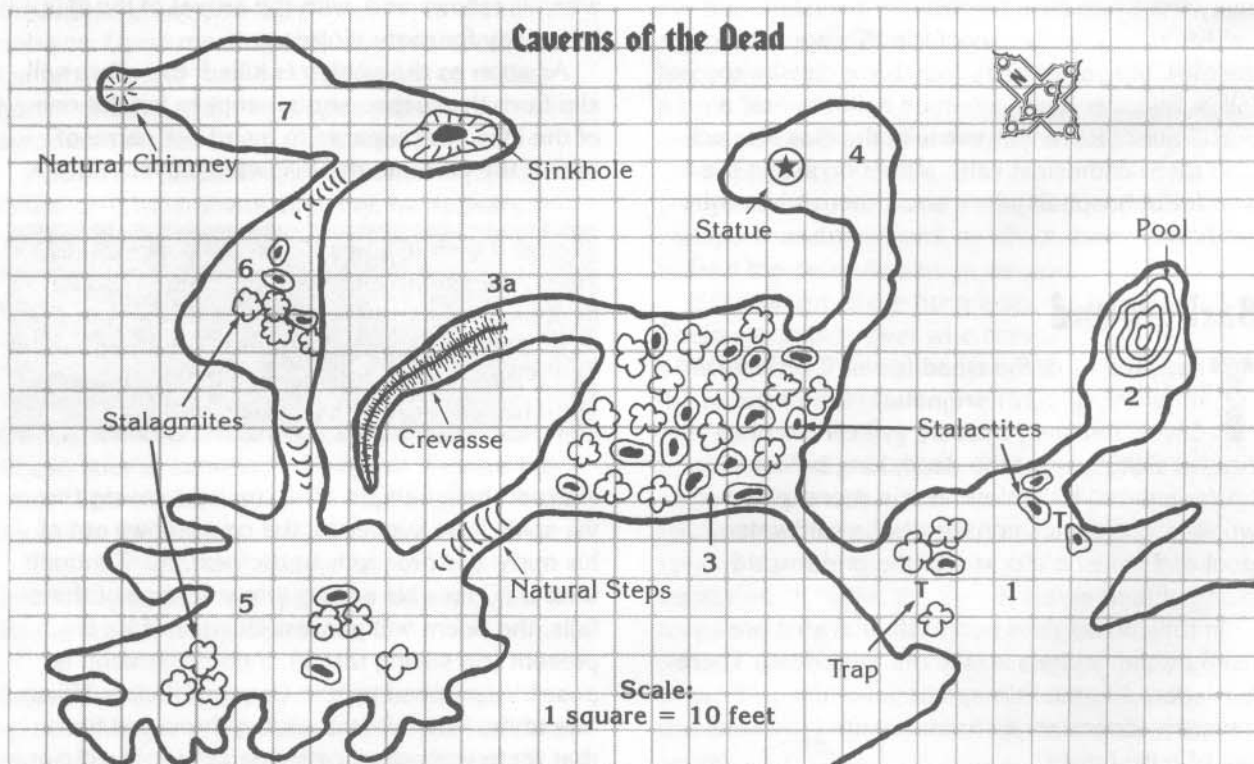



## CAVERNS OF THE DEAD

—witnesses make horror checks); SD nil; MR 10%; SZ M; Int low; AL NE; ML 20; XP 975 each.

When the PCs encounter goblins for the first time and have a round or more to consider a plan of action, the odem will make its presence known (if it has successfully entered the body of a PC). When the PC spies the goblins, the DM should write the following message to the player: *A voice in your head whispers, "I feed upon terror and violence. Attack the creatures you see before you, or I shall let them hurt you—like this. . . ."*

The DM should then announce that the PC is drawing his weapon, dropping it on the ground, and falling to his knees with his hands behind his back. There's no way to resist the odem's control (short of casting *magic jar* or *wish*).

The goblins will howl with delight and leap to the attack. Roll for initiative normally and inform the PC that he can move as desired. If he resists the odem's orders, the spirit will force him to cast aside his weapon and march into the fray, then release its control after one round and repeat its order, and so forth.

**Area 1—Entryway:** There are a number of goblin bodies lying about the entrance in pieces. The way into the caverns is guarded by two traps, both fashioned by human priests who worshiped here in ancient times. Pressure pads, set between stone columns that rise to the ceiling, trigger the release of invisible scythe blades that circle around the pillars, slicing anyone within 4 feet of the stalagmite (Dexterity check with a -4 penalty to dive free). There are two blades in each pillar, and each blade inflicts 1d10 damage. Characters less than 5 feet tall will only be assailed by one blade per pillar.

The goblins know about the traps, but they sometimes forget about them and are killed. They consider it a mark of great honor to be "taken by the god's blade." They reason that Arawn has singled the goblin out to join him.

**Area 2—Pool:** In this cavern, the goblins wash their dead prior to entombing them. The pool,



filled with salt water, is lukewarm and extremely deep, reaching down to the very roots of the mountain.

This is the pool that Forfar's clerics believed to be a portal to Arawn's home plane. The priests enchanted the water with powerful *curse* and *death* spells, so it radiates magic. Anyone who drinks of the water will die in 1d4 rounds unless they successfully save vs. poison for 20 points of damage (Type J poison).

**Area 3—Stone Forest:** This cavern is choked with stalactites and stalagmites that have grown together to form a forest of columns, most of them no more than 1 foot apart. Characters in this area must roll successful Dexterity checks each round or become stuck between two limestone pillars. Stuck PCs can break free by making a successful Strength check or by having a companion pull them free by making the same roll. A dead end corridor (3A) ends in a 20-foot-deep crevasse. The floor is slick along the last 50 feet of the pas-

## CAVERNS OF THE DEAD

sage. PCs who take no measures to avoid falling must roll Dexterity checks for each 10 feet of corridor passed, falling into the crevasse and sustaining 2d6 points of damage if any roll fails.

**4) Ancient Statue:** The single stalactite in this cavern has been carved into the statue of a human figure with a skeletal head and flowing robes. In the statue's hands is a scythe made of solid silver.

The scythe may easily be stolen and is worth 800 gp. It may be used as a weapon, but it is so heavy that it can only be used by a character with a Strength of 16 or greater, and operates as a -2 weapon in any event.

Anyone who steals the weapon invokes the wrath of the god Arawn and is cursed. Until the scythe is restored to the statue, the character suffers horrible nightmares in which he sees himself mowing down his friends and family with the scythe. Unable to rest properly, the character suffers cumulative penalties of -1 per day to all die rolls (to a maximum of -8) and is unable to memorize spells. The curse ends if the character puts back the scythe; otherwise, the nightmares continue even if the scythe is not in the character's possession.

**5) Burial Chamber:** Here the goblins lay out their dead. In each niche of the cavern can be found stacks of different bones—skulls in one corner, thigh bones in another, and so on. A quick count of the skulls reveals that nearly 150 goblins must rest here.

The goblins carefully separate the bones of each skeleton in the naive belief that this will prevent a necromancer from turning them into undead creatures. The animation of the dead is considered a sin against Arawn.

**6) Clustered Stalagmites:** Stalagmites and stalactites are clustered in this cavern in such a way as to provide a natural ambush site. Goblins hiding behind them can easily watch through the cracks as PCs pass by, then spring upon characters from behind. To detect the

goblins hiding here, PCs must declare the intent to search the clusters and then roll a successful Intelligence check.

**7) Steam Room:** A sinkhole plunges down into the rock at one end of this humid cavern while a natural chimney, about 1 foot wide, leads up through the ceiling at the other end. A fine-meshed metal grate has been constructed over the sinkhole. A freshly killed goblin corpse rests on it. The air is filled with the smell of cooked meat; the goblins use this room to remove flesh from the bodies of their dead.

Every five rounds, the sinkhole erupts with a geyser of steam. The whistling steam can be heard throughout the caverns. Anyone in the cavern when this happens suffers 6d6 points of damage (save vs. paralysis for half damage). Those within 10 feet of the exit may attempt a Dexterity check to escape the room. Within one round, the steam vents up the chimney.

When the PCs enter this area, 1d4+10 goblins attack from Area 6, attempting to hem in the PCs until the steam geyser blows.

### Capture and Escape

**W**hen the PCs emerge from the Caverns of the Dead, they will find an unpleasant surprise awaiting them. The goblins have prepared an ambush: Due to his telepathic link with his goblin minions, Tristen is aware of the PCs' intrusion in the Caverns of the Dead. He has relayed this information to goblins outside the caverns, and a number have hurried to the entrance to prepare a trap.

As soon as the PCs step outside the entrance, a weighted net made of wire mesh will be dropped on their heads from above. Have each PC roll for surprise with a -4 penalty; those who fail are caught for 1d4+3 rounds, barring any reasonable means of escape. The net cannot be cut, but three consecutive bend bars rolls will snap enough wire for the character to escape.

Meanwhile, the PCs are immediately set upon by 6d4 goblins. One of them has a *wand of*



## CAVERNS OF THE DEAD

*paralyzation* and fires it at anyone who escapes the net. (It is made of carved bone, set with an amber gem. The command word is “torpidus” and there are just 11 changes left.) The rest of the goblins will attempt to overbear the PCs by attacking any free characters and pouncing on those under the net. For each round that netted PCs struggle after the goblins have pounced on them, the monsters get an automatic hit in an attempt to subdue them. As they strike, they grunt, “You stop fighting,” “You prisoner now,” and other broken remarks to that effect.

The goblins are supposed to bring their prisoners straight to the castle, but they can't resist having a little fun with them first. After disarming the captives, the goblins lead them to a nearby camp (point D on the DM map, page 32) and force one or more of them to participate in the “sword dance,” to run the gauntlet between sword-wielding lines of goblins. (For details, see page 35 of *The Weeping Land*.) If Svendar is present, he will be forced to waltz the

gauntlet first, and he will not survive it.

As part of the celebration that accompanies the dance, the goblins consume copious amounts of a particularly vile beer. They'll even offer some of it to the PCs. (Those who proceed to taste it must make a successful Constitution check or become violently ill, suffering a -2 penalty to initiative, attack, and damage rolls.) After describing some of the festivities detailed on page 35 of *The Weeping Land*, read the following text to the players.

Ever since your capture, the monsters have been leering at you with yellowed fangs and telling you in broken Common how sweet your brains will taste when the time comes to feast.

For a few moments you are left unwatched as the creatures play their odd, bloody games. Your weapons and packs lie not ten feet away, left there apparently to taunt



## CAVERNS OF THE DEAD

you. Your bonds are extremely tight, cutting off your circulation.

Then, you notice a furtive movement in the bushes beside you. A large goblin creeps forth with a wicked grin on its face and a dagger in its hand. The foul creature seems bent on being the first to feast! He leans over you, his foul breath hot upon your cheek.

Allow the PCs to react, then continue if they don't draw attention to themselves.

The monster's blood-red eyes shift between you as he appears to decide which of you would be best to eat. But then he grunts at you in a garbled version of the Common tongue. "You help me, I set you free. You help make Herrd clan chief," he says, thumping his chest at the mention of the name Herrd.

He shows you a battered, tarnished ring on his right thumb. "Clan ApKie must rule. Herrd be clan chief. Yes?"

If the PCs agree (or pretend to agree) to the plan, Herrd quickly sets them free and slips back to join the other goblins. The PCs must then move quickly to recover their weapons and escape. If instead of fleeing they attack the goblins, Herrd slips away from the battle as soon as possible. He will not willingly accompany the PCs. There are 60 goblins in the camp. For a full description of Herrd ApKie, see page 36 in *The Weeping Land*.)

**Herrd Apkie:** THAC0 15; #AT 2 (claw/claw) or 1 (weapon); Dmg 1d6+1/1d6+1 (extra damage due to superior Strength) or 1d8+1 (*sword of wounding*); AC 4; HD 6+4; hp 33; MV 12; SA -2 to opponents' surprise rolls (-4 if opponent meets goblin unexpectedly), face bite (victim save vs. spell to avoid 1d4/round additional, suffocation damage—witnesses make horror checks); SD nil; MR 10%; SZ M; Int avg; AL CE; ML 20; XP 1,100.

**Goblins (60):** THAC0 13; #AT 2 or 1; Dmg 1d6/1d6 (claw/claw) or 2d6 (bite); AC 4; HD 4+4; hp 22 each; MV 12; SA -2 to opponents' surprise rolls (-4 if opponent meets goblin unexpectedly), face bite (victim save vs. spell to avoid 1d4/round additional, suffocation damage—witnesses make horror checks); SD nil; MR 10%; SZ M; Int low; AL NE; ML 20; XP 975 each.

### Complications

- The steam geyser erupts every three rounds.
- One of the goblins in the caverns is armed with a small *drum of deafening* (a drum about 6 inches in diameter and 2 feet long).
- One quarter of the goblins involved in the ambush ride worgs and carry *spears +1*.

### Resolution

If the PCs destroy or desecrate the Caverns of the Dead and then escape the goblins, those creatures begin a frenzied search the PCs who committed the crime. All goblins will recognize the PCs (Tristen has telepathically supplied them with the PCs' descriptions).

Herrd will reappear, from time to time, either to aid or to demand favors of the PCs. He will be cautious, however, and not do anything treasonous within view of any other goblins (who would telepathically notify Tristen of his actions).

The DM might wish to develop a scenario in which Herrd is pursued by his fellow goblins and, fearful of being taken to Tristen for punishment, he turns to the PCs for help. Of course, Herrd might only be pretending to be on their side, in an effort to curry favor with his lord.

If Svendar is present and not killed during the course of this encounter, he will abandon the PCs at this point, to search for the portal to his home domain. If the PCs wish to follow him, he will eventually lead them to the Maw of Arawn. See "Music of the Mists" on page 25.



## HOWLING VENGEANCE



*Like a dog, he hunts in dreams, and thou art staring at the wall, Where the dying night-lamp flickers, and the shadows rise and fall.*  
—Tennyson

This encounter introduces PCs to the druids. It can take place only at night, at which time the PCs blunder into a Sacred Grove. There, they are magically tempted to join the Wild Hunt . . . or they may become its prey! The

DM will want to review the section concerning the Wild Hunt, on page 49 of *The Weeping Land*.

### Background

**S**helaugh and her rowan faction have been practicing a nightly ritual of summoning the Wild Hunt. Unfortunately, this Wild Hunt is not the real thing, but is spun out of the Mists of Ravenloft. It doesn't seek evil, as Shelaugh believes. Instead, the Hunt pursues the nearest non-neutral creature(s) who successfully resists its magical call, including the PCs.

### Setup

When night falls and the PCs make camp, read the following player text.

The forests of this domain are even more threatening by night than by day. The gnarled trees shift in the wind, and flashes of lightning give bright, brief glimpses of dark shapes scuttling into their holes.

As you settle in for the night, a distant buzz intrudes upon the silence of the forest. After a minute it grows louder, and you perceive that it is a chant, coming from not too far off.

If the PCs investigate the chanting, lead them to a point about 200 yards from their camp. Then read the next block of player text.

As you close on the chanting, a subtle change in the forest around you becomes apparent: The trees here seem a bit straighter, the ground firmer underfoot. The branches that brush your arms no longer have the feel of skeletal hands, but are instead covered with tiny leaves.

Through a thick swath of foliage you spy the source of the chanting. Twelve hooded figures hold hands and stand in a circle on the other side of the bushes. As you watch, the chanting increases in volume and speed. As one, the figures turn and begin to run in a clockwise direction, still holding hands.

Suddenly, an eerie howl erupts from the center of the circle. Glowing green eyes appear, and in a few more seconds, the body of a hound forms around them. The animal springs from the circle and stands there, sweeping its head from side to side, growling impatiently.

Allow the PCs to react at this point. They cannot stop the Wild Hunt from forming, even if they attack the druids. If they either attack the druids or any member of the Hunt, they are automatically chosen as its prey. The PCs may, however, choose to flee the area, in which case they will not become the prey. Of course, they are still required to make saving throws vs. the call of the Master's horn.

If the PCs flee the area, read the following block of player text.

You can still hear the chanting of the circle and the increasing growl of massive dogs in the forest behind you. They seem to be working themselves into a frenzy.

Suddenly, a deep, clear note pierces the air, blowing from a hunter's horn. Its call sends shivers through you, and your blood yearns to romp through forest and field as its echo dies on the wind.

## HOWLING VENGEANCE

If the PCs continue to watch the proceedings, read the next block of player text instead.

Another set of eyes begins to glow within the circle, and then another hound joins the first. In a matter of moments, nearly two dozen hounds materialize and leap over the heads of the chanting figures. Now a final figure appears, that of a dark-skinned man holding a spear and wearing a helmet crowned with horns. He, too, throws his head back, and howls at the night. Then he raises a ram's horn to his lips and blows a note that stirs something deep in your blood.

All druids except Shelaugh transform into huge dogs as soon as the Master blows his horn, and they are treated as regular members of the Pack. Shelaugh remains human.

### Predator or Prey?

**A**fter the horn sounds in either case, PCs who are not visible to the members of the Wild Hunt must roll saving throws vs. spell.

Those who fail their rolls are irresistibly summoned to join in the Hunt. They will change into dogs and run tirelessly with the Pack and attack whatever prey is chosen until the prey or the Master and entire Pack are destroyed.

Those who make successful saving throws must choose whether or not to join those who fail. If they resist the call of the Master's horn but have missed their chance to flee, they become the prey. Even their comrades who have joined the Hunt must attempt to destroy them. The players may continue to run their characters throughout the Hunt, so long as they continue to role-play the situation; they may not refuse to pursue their comrades.

Completely neutral-aligned characters automatically fail their saving throws, and they are never considered prey by the Hunt unless they attack it before the Master blows his horn.

If none of the PCs becomes the prey, then the Wild Hunt will choose a wandering pack of 25 goblins as its prey.

**Master of the Hunt:** THAC0 1; #AT 3; Dmg 1d6+9 (*spear* +3, plus Str bonus); AC 0; HD 20; hp 200; MV 18; SA nil; SD nil; MR 25%; SZ L; Int genius; AL N; ML 20; XP 12,000.

**Pack of the Wild Hunt (31, including transformed druids):** THAC0 14; Dmg 2d4; AC 2; HD 5; hp 30 each; MV 21; SA see below; SD see below; MR 15%; SZ M; Int non; AL N; ML 20; XP 500 each.

Special attacks include the ability to cause *fear* (as the spell) in any mortal the pack is pursuing. The Pack can swarm enemies, giving every hound an attack, no matter how limited the space. Also each hound can use a green flame breath to inflict an additional 5 hp of damage on any attack that hits (once per turn).

Special defenses include the equivalent of a permanent *protection from evil* spell.

**Shelaugh (P12—druid):** THAC0 14 (10 with *staff-spear* +4); Dmg 1d6+5 (Str bonus); AC 4 (*leather armor* +2, *cloak of displacement*); hp 52; MV 12; ML 15; AL N.

S 16, D 12, C 11, I 12, W 13, Ch 17.

Personality: Stern, authoritative.

Spells: *Bless, combine, cure light wounds, detect snares and pits, entangle, faerie fire, shillelagh; bark skin, flame blade, produce flame, obscurment, trip; flame walk, hold animal, locate object, plant growth, summon insects; cure serious wounds, neutralize poison, produce fire; air walk, wall of fire; fire seeds, heal.*

Magical items: There are 10 red beads in Shelaugh's hair that are *beads of force*. She also carries a *wand of enemy detection* and wears a *ring of fire resistance*.

Shelaugh can cast *continual light* on command. Also, her bright red hair gives her the innate ability to cast *analyze balance, animal friendship, pass without trace, and trip* (one-round casting time, no components required—see "Spellcasting Abilities of Redheads" on page 44 of *The Weeping Land*). Of course, Shelaugh enjoys all powers bestowed upon a druid of her level, as listed in



# HOWLING VENGEANCE

the *Player's Handbook* (except the ability to learn the languages of woodland creatures).

**Goblyns (25):** THAC0 13; #AT 2 or 1; Dmg 1d6/1d6 (claw/claw) or 2d6 (bite); AC 4; HD 4+4; hp 22 each; MV 12; SA -2 to opponents' surprise rolls (-4 if opponent meets goblin unexpectedly), face bite (victim save vs. spell to avoid 1d4/round additional, suffocation damage—witnesses make horror checks); SD nil; MR 10%; SZ M; Int low; AL NE; ML 20; XP 975 each.

## Complications

- The Hunt trees 1d6 of the goblyns. Unfortunately, the tree is an undead treant (see the RAVENLOFT® appendix of the MONSTROUS COMPENDIUM™). Normally, this evil plant would immediately attack and feed upon the goblyns, but faced with a pack of good creatures, the undead treant decides to deal with the greater threat.

**Treant, Undead:** THAC0 5; #AT 2; Dmg 5d6/5d6; AC 0; HD 15; hp 110; MV 12; SA see below; SD see below; MR nil; SZ H; Int high; AL CE; ML 15; XP 15,000.

Spells as 4th-level druid: *Cause light wounds, create water, entangle, dust devil, obscurement*. Immune to *sleep, charm, and hold* spells, as well as *control undead* and *control plants*.

On a natural roll of 19 or 20, opponents are knocked prone and stunned for one round per 5 points of damage. If the treant is not engaged in melee, it inserts 3d4 rootlike appendages into a stunned victim's skin, inflicting 1 point of damage per round per root for two rounds, and then 1d3 points of damage per round per root as it draws the victim's blood. All tendrils must be cut to free the victim (AC 5—one blow snaps the root). Attacks against a feeding undead treant gain a +2 bonus.

- The pack blunders through a growth of phycomids on its way to the undead treant.

**Fungus, Phycomid (1d4):** THAC0 15; #AT 2; Dmg 1d4+2/1d4+2; AC 5; HD 5; hp 36 each; MV 3; SA see below; SD nil; MR nil; SZ T; Int unratable; AL N(E); ML 14; XP 975 each.

Phycomids discharge an alkaline fluid with a range of 1d6+6 feet. Victims hit by this substance must successfully save vs. poison or sprout mushroomlike growths in the infected area after 1d4+4 rounds, suffering 1d4+4 points of damage. The growth then spreads across the victim's body, killing him in 1d4+4 turns. A *cure disease* spell stops the growth.

## Resolution

If the PCs join the Hunt and talk to the druids afterwards, Shelaugh treats them with courtesy and presents the gift of a deer antler consecrated to their patron deity Belenus. (Note that they know nothing of its power over Tristen—see page 20 of *The Weeping Land*.) The druids also will impart information about the realm (see "What the Druids Know of Forlorn" on page 50 of *The Weeping Land*), even drawing a map of Forlorn and naming some geographical points of interest for the PCs. (The DM may display the poster map of Forlorn at this time.) The druids will not discuss Sanctuary unless the PCs have already seen it.

Shelaugh's faction will encourage the PCs to battle the evil in the castle, but they will not join the PCs—they have learned long ago not to trust strangers. PC druids will be invited to join the rowan faction, but they must abandon their comrades to do so. Such PCs will be shown the way to Sanctuary. If they pass the information to the party, the druids will view it as treason.

Before leaving, the druids note the color of each PC's hair. If there are any redheads in the party, the druids will question them about their ancestry, but will not explain the reason behind their questions. (They are looking for redheads with innate spell abilities to join their cause.)

## SHATTERED SECRETS



*at thou and drink; tomorrow thou shalt die . . .*

*Watch thou and fear; tomorrow thou shalt die . . .*

*Think thou and act; tomorrow thou shalt die . . .*

—Dante Gabriel Rossetti

The PCs are attacked by zombie wolves, at which time they accidentally find a tomb that leads to one of the cave complexes known as Sanctuary. If the PCs fail to make friends with the druids, Sanctuary is exposed to Tristen ApBlanc and the PCs will have contributed unwittingly to the persecution of

Forlorn's forces for good.

The PCs also have an opportunity to explore Sanctuary. While there, they may encounter one of Tristen's victims, a lost one, and they may be asked to seek a hidden room that houses a magical item important to the druids.

### Background

Sanctuary was created to provide the druids of Forlorn with a place to hide from the wrath of Tristen ApBlanc and his minions. There are several cave complexes hidden across the domain (marked with an E on the map on page 32), and Tristen would like nothing better than to ferret them out and destroy their inhabitants.

For a full discussion of Sanctuary, see page 30 in *The Weeping Land*.

### Setup

The PCs are attacked by a pack of zombie wolves (see page 96 of *The Weeping Land*), at which time they accidentally discover Sanctuary. Read the following player text.

As you travel along a ridge through a sickly patch of forest, you spy movement ahead. It looks like a mass of large wolves are digging furiously into the side of a hill. The wind shifts, blowing into your face, and the unmistakable odor of rotten flesh makes you want to gag.

These wolves are definitely not living creatures. They are covered with mangy fur and gaping, bloodless wounds. Some of them stagger on three legs while the fourth dangles by a sinew. Others tear at the earth with broken or missing lower jaws. Their movements are stiff and deliberate, but lack ambition.

Now the wind shifts again, toward the undead creatures, and it looks as if the scent of your living blood has reached them. They stop their digging all at once and turn their dirt-encrusted muzzles in your direction. Flat, lifeless eyes stare into yours. One of the creatures throws back its head, lets out a strangled howl, and the horrifying pack immediately attacks.

PCs may be called upon to make fear and horror checks at the sight of the undead beasts.

**Zombie Wolves (30):** THAC0 19; Dmg 1d4+1; AC 6; HD 2+2; hp 12 each; MV 9; SA nil; SD immune to *sleep*, *charm*, and *hold* spells as well as death magic, poison, and cold-based spells; MR nil; SZ M; Int non; AL N; ML special (turned as zombie); XP 120 each.

At some point in the midst of battle, the PCs should accidentally break the surface of the ground, exposing a cavern below. The DM should decide when and how to introduce this development. If the PCs decide to run away from the zombie wolves before they attack, the ground might give way beneath the heaviest PCs, so they sink in to their waists (losing AC and shield bonuses and suffering a -2 penalty on attack rolls), stalling the party so the wolves can catch up (if engaged in melee, characters cannot extricate themselves from the hole without allowing all zombie wolves around them a free attack with a +4 bonus). Otherwise, the ground might give way under a PC's



# SHATTERED SECRETS

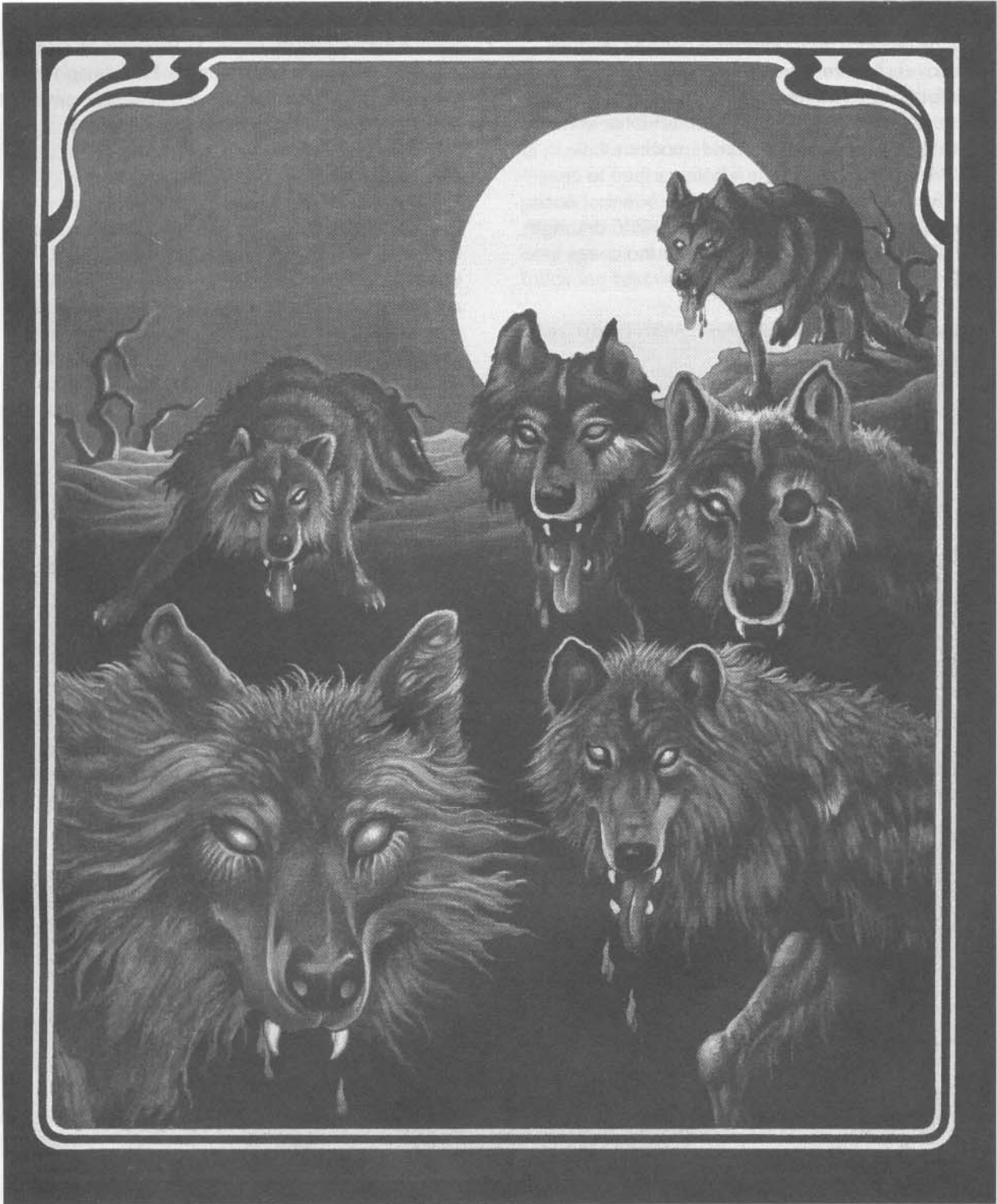

## SHATTERED SECRETS

PC's foot during combat, causing one leg to sink into the ground, up to the thigh (same penalties as above). Another way to expose the cave is to wait for a PC to make a critical miss during battle with the zombie wolves, at which time his or her weapon strikes the ground and knocks a hole in it. Still another idea is for the whole surface to cave in if three or more PCs stand within 5 feet of each other during the battle (20-foot fall—2d6 damage; the DM must decide how much ground caves in and how many creatures fall).

When the PCs investigate the cavern below, read the next player text block.

You've stumbled upon a tomb of some sort. There are seven bodies laid to rest on short wooden pedestals in this chamber, with three more pedestals empty and waiting for future users. The bodies are loosely wrapped in gauze, and each of them holds a shiny weapon under its hands.

The weapons are silver *sickles* +1. They are in such pristine condition that the PCs should conclude they're magical, even without the aid of a *detect magic* spell. Taking the weapons constitutes an act of desecration, which calls for a Ravenloft powers check (4% base chance; 8% for characters of lawful good alignment, 2% for thieves). Furthermore, if the PCs are seen with these ceremonial burial treasures by the druids of Forlorn, they will instantly be marked as enemies and attacked at every opportunity.

PCs who take time to search the cave easily find the secret door in the back—a mud-encrusted stone that rolls into the tomb (+2 bonus to searching attempts). Once this door is open, the PCs can explore the other caverns that make up Sanctuary.

### Entering Sanctuary

**T**his cave complex is one of five hidden across Forlorn (marked with an E on the map on page 32). Shelaugh's faction cares

for the western set of caverns and Maeve's faction cares for the caves to the east. A two-mile-long tunnel, shored up by boards and only three feet high, connects the two sets of caves. It allows druids to disappear into one set of caverns and reappear some distance away, effectively vanishing from their pursuers.

Characters who negotiate this dark tunnel must do so on their hands and knees. The shaft forks every 500 feet or so, and each branch ends after about 50 feet. One of the branches is a dead end while the other ends in a secret door (the DM should roll dice, giving PCs a 50/50 chance to take the correct branch). All Forlorn druids know the correct route.

At any given time, there are small groups of 1d4 druids in any cave. Depending upon where they are encountered, the druids might be recovering from wounds, holding meetings, tending their weapons, creating holy symbols, tending seedlings, or storing seeds.

The DM may decide how much of the west complex the PCs are able to explore before their intrusion is detected. Upon discovering the PCs, the druids react with alarm and demand to know how they found and entered Sanctuary.

If the PCs are carrying sickles from the tomb, the druids don't wait for an answer, but immediately run away. If they can put 60 feet between themselves and the PCs, the druids slip through a secret door and escape. After that, the druids will attack the PCs guerilla-style, with traps and quick hit-and-run assaults.

If the PCs attempt to crawl through the two-mile tunnel, the druids use *warp wood* or *stone shape* spells to collapse the supports, hoping to bury the PCs alive. Each time they attack, the druids cry, "Desecrators!" or "Grave robbers!" (telling the PCs why they are so unwelcome).

It remains possible for the PCs to make peace with the druids, if the PCs are persistent. Replacing the silver sickles in the tomb will help, but the druids will be offended at the PCs' infiltration of Sanctuary in any event, and the PCs must make concerted efforts, and possibly sacrifice a magical item of their own, to win the druids' guarded trust.



## SHATTERED SECRETS

**NPC Druids (1d12) (P5):** THAC0 18; Dmg 1d4+1 (sickle); AC 10; hp 25–35; MV 12; SA spells; SD nil; MR nil; SZ M; Int Avg; ML 10; AL N; XP 200 each.

The DM is free to add leather armor to any druid (AC 8), particularly those of Shelaugh's rowan faction. Spells available to druids come from the spheres of All, Animal, Elemental, Healing, Plant, and Weather, with minor access to the sphere of Divination.

Favorite spells of the rowan faction: (1st) *Combine, cure light wounds, entangle, shillelagh*; (2nd) *charm person or mammal, flame blade, heat metal, warp wood*; (3rd) *call lightning, summon insects, snare*.

Favorite spells of the oak faction: (1st) *Bless, animal friendship, detect magic, locate animals or plants, pass without trace*; (2nd) *charm person or mammal, goodberry, obscurement*; (3rd) *hold animal, plant growth, stone shape*.

**A) Resting Place:** These places are stocked with 3d4 baskets of dried or fresh food (each basket holds enough food for one person for two days) and 1d6 pottery jars filled with water (each jar holds enough water for one person for four days). They also hold blankets and other bedding, candles, and games or books. A cache of medicinal herbs may be employed by any PC with the healing proficiency, to restore 1d4 hit points to injured characters (once per day). There also is a 25% that one of the following potions will be present (roll 1d6): (1) *Elixir of health*; (2) *Keoghtom's ointment*; (3) *potion of extra-healing*; (4) *potion of healing*; (5) *sweet water*; (6) DM's choice.

**B) Meeting Place:** These caves are undecorated, save for soft moss carpeting and a few cushions. These caves tend to be natural because the druids value the beauty of the stone walls, which have glittering streaks of metal or brilliantly colored minerals slanting across them.

**C) Tree Nursery:** In these caves, Maeve's faction has planted trees. The walls glow brightly under the effects of a series of *continual light* spells (obligingly cast by Shelaugh's followers), and they provide illumination for the seedlings that sprouted on the barren stone floor on the last druidic holy day (equinox or solstice). When the trees are large and strong enough, they are transplanted outdoors, expanding the sacred groves.

**D) Crystal Workshop:** The walls of these caves glitter and sparkle with thousands of tiny quartz crystals. Here and there are crystals anywhere from egg- to fist-sized. Shelaugh and her followers fashion the holy symbols of their god Belenus from these. The ritual involves four druids—two male and two female—who simultaneously cast *bless, combine, produce flame* (the flame is trapped within the crystal) and *detect evil*. Even though the latter spell is otherwise useless in Ravenloft, it is still required to create this holy symbol.

**E) Weapons Storage:** These caves are used to store weapons used by Shelaugh's faction. Each cave contains 3d6 weapons of the following types: club, dart, spear, dagger, sling, staff, and wooden shield. There also are 1d4 suits of leather armor. There is a 10% chance that one of the weapons has a +1 enchantment.

**F) Seed Storage:** These caves are used by Maeve's faction to store sacks of seeds of various woodland plants. Should the sacred groves ever be completely destroyed, the druids would use these seeds to begin again.

**G) Holding Cell:** A few weeks ago, Shelaugh's faction captured a lost one (see "Men" in the RAVENLOFT® appendix of the MONSTROUS COMPENDIUM™), a former adventurer from Kartakass named Lazlo Meistersinger, who was driven mad after encountering the ghost of Morholt ApBlanc in Castle Tristenoira. The druids have imprisoned him here (for his own safety) behind a heavy, locked door, and they

# SHATTERED SECRETS

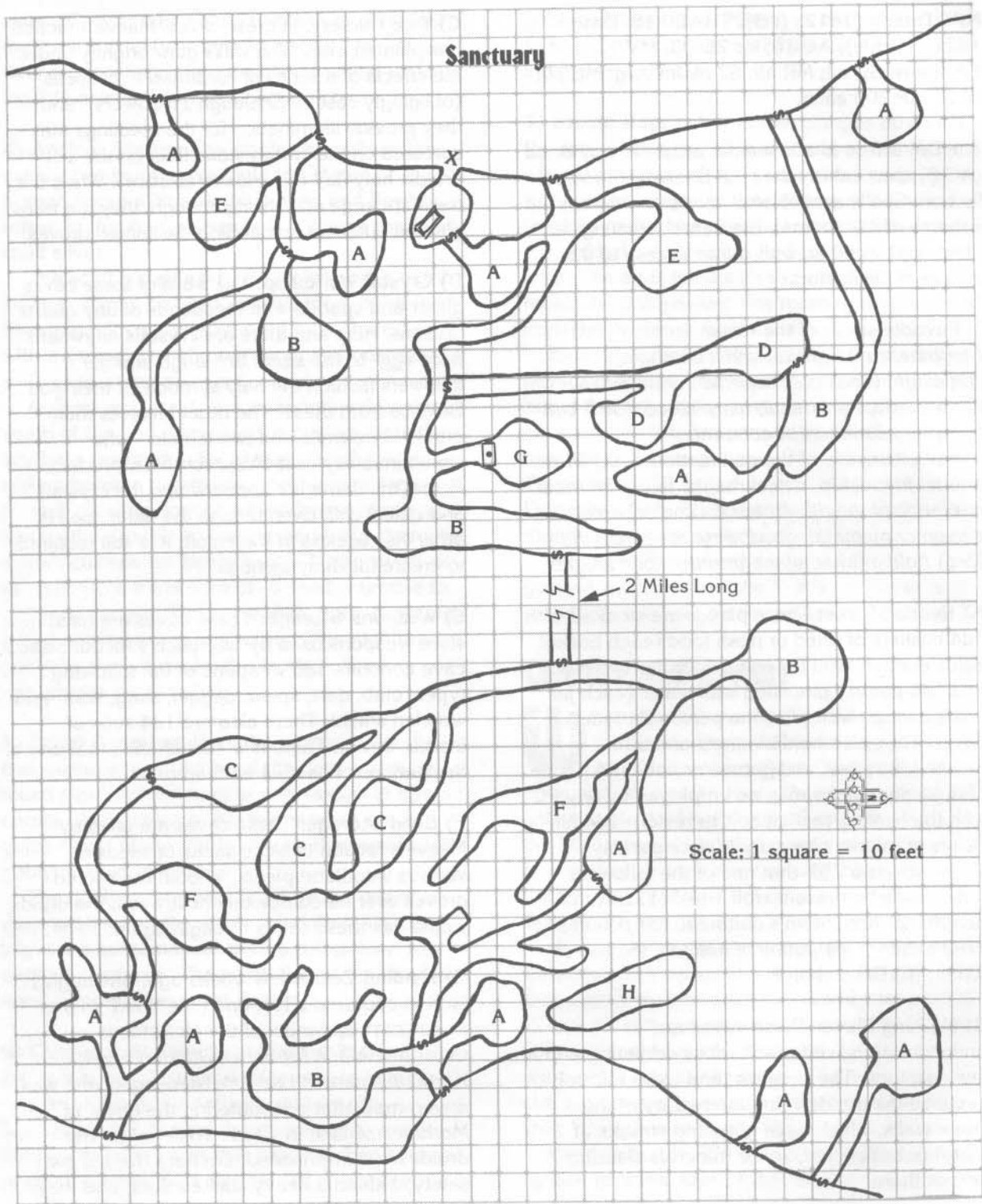



## SHATTERED SECRETS

are trying to restore him to sanity with healing magic. They have provided Lazlo with clean bedding, fresh water, and healthy food. The druids have treated him kindly, but he has flashbacks of horrifying creatures in kilts, and he will lash out at anyone who approaches him in one of these garments.

If any of the Forlorn druids are present, they explain that they found Lazlo wandering by the shores of the Lake of Red Tears and grabbed him before Aggie got to him. They recognize him as a victim of *something*—probably the evil lord in the castle—but Lazlo has been too violent to deal with. Perhaps, they suggest, a PC priest or paladin can help him.

If the PCs open the locked door to Lazlo's cell, read the following player text.

As the heavy door swings open, you notice deep gouges on its inner side. It appears as if some wild beast has clawed the wood to slivers.

In a corner of the darkened cave, something stirs, then rises from a pile of blankets. It appears to be a man who has been beaten to deformity. One eye is sealed shut, his drooling mouth is twisted into a horrid snarl, and tufts of white hair stand out at wild angles from his scalp. The man's arms are twisted into shapes in which human bones were not meant to bend, and his feet are withered to mere stumps.

The creature fixes its good eye upon you and shambles forward—arms outstretched and claws grasping—gibbering incoherently.

Lazlo is in agony and mistakes the druids' attempts to help him for torture. As long as none of the PCs wears a kilt, he will only try to push past them and run away. If caught and held, he merely stares at the air.

The DM should award experience points to the PCs if they try to help him and an additional 1,000 XP if they show him the way out of Sanctuary. If they attack and kill Lazlo, the DM should penalize the PCs 1,000 XP for their hair-trigger reaction.

**Lazlo (lost one):** THAC0 20; Dmg 1d2 (fist); AC 10; HD 1 – 1; hp 5; MV 6; SA rage (–1 to opponents' surprise rolls); SD nil; MR nil; SZ M; Int low; AL N; ML 5; XP 7.

Lazlo can be cured with psionic *psionic surgery* and a *polymorph* spell, but such powers are beyond the means of the druids (and probably the PCs as well).

**H) Secret Room:** Nearly 100 years ago, two high-level druids, Gregory and Dorinna, created a magical device of great power: the *horn of the sacred grove*. Through the magic in this *horn*, it was said, balance would be restored to the land and the lord would be defeated. Before the artifact's powers could be tested, though, Dorinna was captured and dragged away to the dungeons of Castle Tristenoira. Gregory, fearing the artifact would be captured by the goblins, hid it in a place of safety, but he was killed before he could pass on word of its location. As he died, Gregory cried, "None of this cursed land shall ever find the *horn!*" As a result, no *locate object* spell, nor any other means of finding the *horn*, works for any native of Forlorn. An outsider must find it. . . .

Recently, the druids asked a Vistani fortune-teller about the *horn*, to which she replied, "Earth protects the secret. Hidden from the sun, by shovel may they find it, by the sword shall it be won."

Maeve interpreted the prophecy to mean the relic is hidden in a secret cave somewhere within Sanctuary. Her followers have dug several short tunnels, but none has located the secret cave. Shelaugh has focused upon the word "they," thinking that it must be the goblins who will locate the artifact, and then the druids will have to fight to capture it.

In fact, "they" refers to the PCs. If the PCs meet the druids and establish a relationship with them, Maeve will figure this out and urge the PCs to search for the lost object. Once the *horn* is described to the PCs—a brightly polished horn carved from an antler, trimmed with gold and studded with glittering crystals—a *locate object*

## SHATTERED SECRETS

spell will lead the party to the cave marked "H" on the Sanctuary map, where a drawing of the *horn* is carved into the wall.

When the PCs break through to the cave, it appears to be empty. If the PCs search, read the following player text.

As you poke around in the rubble on the cavern floor, a shimmering, transparent image materializes at the center of the cave. It takes a human form, that of a man in a ragged, bloody kilt and shirt. Skin hangs in ribbons from his arms and legs, but it's his face that's the most terrifying: Nothing is left of it but a gaping, bloody gash! His scalp has been peeled back and his skull split open like a nut. A low moan fills the room, and the spirit reaches for you.

The spirit is the *geist* (see the RAVENLOFT® boxed set) of Gregory, the druid who hid the *horn of the sacred grove* and later was torn to shreds by goblins. Upon meeting him, PCs must make fear checks and may be called upon to make horror checks, too. Any druids present automatically fail their checks and flee.

Allow the PCs to declare actions and roll for initiative. If they attack Gregory, he appears to teleport out of the way of their weapons, making it seem that he is taunting them. If they wait and watch, or give up trying to attack him, Gregory's spirit beckons them to a wall. He points to a series of faint scratches in the stone. They read: "Seek the misty mouth when it spits the sun into the sky. That which you seek lies in the valley whose floor is carpeted with death. Beware the mist." There also is a representation of the *horn* carved in the wall.

The "misty mouth" is the Maw of Arawn. Let the PCs speculate first upon the meaning, but Maeve figures it out if they don't.

**Geist:** THAC0 nil; Dmg nil; AC 10; HD nil; hp nil; SA sight causes panic; SD invulnerable; MR 100%; SZ M; Int high; AL N; ML 20; XP 0.

### Complications

- The zombie wolves are joined by 20 goblins in the third round of battle.

**Goblins (20):** THAC0 13; #AT 2 or 1; Dmg 1d6/1d6 (claw/claw) or 2d6 (bite); AC 4; HD 4+4; hp 22 each; MV 12; SA -2 to opponents' surprise rolls (-4 if opponent meets goblin unexpectedly), face bite (victim save vs. spell to avoid 1d4/round additional, suffocation damage—witnesses must make horror checks); SD nil; MR 10%; SZ M; Int low; AL NE; ML 20; XP 975 each.

- Hostile druids encountered within Sanctuary are at the 7th level of experience.

### Resolution

If the PCs explain how they found Sanctuary, the druids realize the complex is compromised. They quickly collapse all caves adjacent to the tomb, hoping to make it appear that the burial place is an isolated area. If the discovery of the tomb goes unreported, however, a force of 80 goblins enters Sanctuary and begins a rout. If the PCs attack the goblins in sight of druids, a hasty alliance may be struck. Shelaugh then appears and rallies a force to hold off the goblins while the tunnel to the east complex is collapsed and obscured, at which time she tries to lead the defenders to an escape.

If the secret of the *horn* is learned, Maeve and Shelaugh debate over who is to wield it and where to find it. Both leaders insist upon leading the recovery, but both agree that the PCs are best suited to finding the *horn*. If the PCs agree to undertake the mission, Shelaugh presents each of them with a holy symbol of Belenus. (Note that the druids have no idea of the symbol's power over Tristen.) Any information contained in "What the Druids Know of Forlorn" on page 50 of *The Weeping Land*, may be related, and a map of Forlorn may be provided. (The DM can display the poster map included in this boxed set.) Proceed to the next encounter section.



## MUSIC OF THE MISTS



*ill't ne'er be morning?  
Will that promis'd light  
Ne'er break, and clear  
these clouds of  
night?  
Sweet Phosphor, bring  
the day,  
Whose conquering ray  
May chase these fogs;  
sweet Phosphor,  
bring the day.*

—Francis Quarles

This encounter introduces the PCs to the Maw of Arawn and its valley of bones.

They may also witness the effects of a border closure.

In the course of this encounter, the PCs battle a mist horror and a bone golem. If they are victorious, they may recover a druidic artifact, the *horn of the sacred grove*, aiding the druids in their fight against evil. The DM will want to become familiar with that new artifact before running this encounter (see below).

### Background

As stated earlier, two druids named Gregory and Dorinna created a magical device of great power about a century ago: the *horn of the sacred grove*, whose magic was said to be great enough to restore balance to the land and defeat its evil lord. Before the artifact's powers could be tested, though, Dorinna was captured and dragged away to the dungeons of Castle Tristennoira. Gregory, fearing the artifact would be captured by the goblins, hid the *horn* in the Maw of Arawn, but he was killed before he could pass on word of its location.

Gregory was torn apart by Tristen's goblins, much to Tristen's anger. And as he died Gregory cried, "None of this cursed land shall ever find the *horn*!" Hence, none of Forlorn's denizens has ever discovered its whereabouts.

### The Horn of the Sacred Grove

This druidic artifact is true neutral in alignment. Created by Gregory (who worshiped Daghdha) and Dorinna (who worshiped Belenus), it draws upon the powers of each god. Many of these powers can only be utilized by a person who knows the correct sequence of notes to play. Other powers are only effective if the *horn* is in the hands of a druid.

#### Major Powers

- Once per week, at night only, the *horn* can be used by a druid (or a priest of either Daghdha or Belenus) to summon the Wild Hunt (see page 49 of *The Weeping Land*).
- Every other day, the *horn* can be used to cast the 7th-level priest spell *sunray*. A beam of sunlight up to 200 feet long and 10 feet in diameter at its far end emerges from the mouth of the *horn*.
- Every other day (alternates with the *sunray* power), the *horn* can be used to create a *heroes' feast* (per the 6th-level priest spell) that will feed 12 people.

#### Minor Powers

- The bearer of the *horn* is completely immune to normal fires and gains a +4 bonus to saving throws vs. magical fire.
- Once per day, for three rounds, the *horn* may be used as a listening device (the mouthpiece is held against the bearer's ear) to understand the speech of a single animal or plant, per the 4th-level priest spell *speak with plants* or the 2nd-level priest spell *speak with animals*.
- Once per week, the *horn* may be used to *control winds*, per the 5th-level priest spell.
- Four times per day, kissing the *horn* in the hands of a druid results in the benefits of the 1st-level priest spell *cure light wounds*.

#### Corrupting Effects

- The first time the *horn* is blown, the sounder must successfully save vs. spell or suffer an alignment change to true neutral.
- If the bearer of the *horn* is a nondruid and

## MUSIC OF THE MISTS

blows the *horn* at night, there is a cumulative 5% chance per sounding that the *horn* will call the Ravenloft Wild Hunt. The bearer of the *horn* automatically becomes the prey. The Pack simply seeks to surround or tree the sounder, whereupon the Master silently steps forth and holds out his hand, expecting the bearer to give him the *horn*. If refused, the Wild Hunt attacks.

### Weaknesses

The *horn of the sacred grove* was created by powerful magic, and it cannot be destroyed by ordinary means, despite the fact that it appears fragile. Normally, the *horn* would be destroyed only if removed to a plane where the Celtic gods have no influence. Because the gods' connection with the domain of Forlorn is so tenuous, though, the *horn* loses power if all of the groves are destroyed or defiled.

### Setup

There are three ways that the PCs might enter this encounter:

**With Svendar:** If the PCs have played the "Still Waters" encounter (page 6), then Svendar may have joined the party (or they may have joined him) and eventually led the PCs to the Maw of Arawn.

**With Maeve and Shelaugh:** After playing the "Shattered Secrets" encounter (page 18), the PCs may be asked to find the *horn* by Maeve and Shelaugh, who will come with them.

**With Yolna and Sardo:** If none of the above encounters has been played, the PC meet Yolna and Sardo, a pair of lovers who are fleeing the wrath of Lord Harkon Lukas of Kartakass, who wishes to kill Sardo because he is a werewolf.

When Yolna and Sardo attempted to leave Forlorn on their way to Gundarak (at point F on the map on page 32), Lord Tristen ordered his minions to skirmish with the pair to test their

strength. By shifting to half-wolf form, Sardo easily fended off the goblins, and the pair thought they might break free. However, just as Sardo tried to leave Forlorn, Tristen closed the borders and the werewolf fell into a magical paralysis (see "Closing Forlorn's Borders" on page 23 of *The Weeping Land*).

The border closure caught Sardo in the act of transforming back into human form, and Yolna has bandaged his head to hide his lupine ears. Otherwise, the only clue to his lycanthropy lies in the fact that his body is covered in thick, curly hair.

Yolna quickly realized that she too might be paralyzed if she tried to leave Forlorn, so she dragged Sardo away from the point where he lost mobility and hid him as best she could. She then wandered in search of help and met Svendar by the Lake of Red Tears, who managed to convince her that she should take Sardo to the Maw of Arawn.

When the PCs discover Yolna and Sardo, the young woman is out of breath and resting. She has been dragging her lover toward the Maw of Arawn, and she's exhausted.

You spy movement ahead of you. Someone or something must have heard you coming and is trying to hide behind the husk of a dead tree. Raising your weapons, you prepare for whatever challenge might come.

Instead, a pretty young woman, her trousers and blouse smeared with mud, steps from the shelter of the tree and staggers toward you, her hands clasped in front of her.

"Please good people," she begs in a melodious voice. "Help me. The monsters have been pursuing my cousin and me ever since we entered this land. We tried to escape, but my Sardo was bespelled and we could not leave. I've carried him this far, but I've no strength left. Our only chance lies in escaping through the mists that blanket that mountain behind you. Please, won't you help my cousin and me reach the peak?"



## MUSIC OF THE MISTS

Yolna introduces herself as a villager from the town of Skald in the neighboring domain of Kartakass. Behind the tree lies the rigid body of Sardo. His head is wrapped in a bloody bandage and his clothes are in shreds, as if they have been torn by claws. His eyes are open, and it is clear that he is fully conscious, but he's utterly paralysed, unable even to blink.

With a little questioning, the "monsters" Yolna refers to are identified as goblins. (If the PCs have not yet encountered goblins, Yolna's description serves as a warning.)

In order to enlist the PCs' aid and sympathy, Yolna explains that she and Sardo are in love, but they were forced to elope because the law in Kartakass prohibits the marriage of cousins even as distantly related as themselves. They hoped to travel to Barovia and make a new life there, but they were ambushed by goblins. They tried to flee, but Sardo fell into a mysterious paralysis as soon as he attempted to cross the border into Gundarak. Now their only hope lies in escaping through the Mists.

Sardo's strawberry blond hair might lead the PCs to conclude that the goblins are chasing the couple because they think he might be a druid. In fact, Sardo has no druidic spell-casting abilities. The reddish tint to his hair is a result of the reddish tint his pelt takes on when he transforms into a wolf. (Kartakan natives have fair hair, blue-violet eyes, and pale skin.) Yolna will not reveal that Sardo is a lycanthrope.

Should the PCs find a means to remove the magical paralysis from Sardo, and then exhibit the least hostility, he will take his half-wolf form and attack them. He will especially take steps to protect Yolna at any cost.

**Yolna (T1):** THAC0 20; Dmg 1d4 (dagger—double damage for back stabs); AC 8 (Dex bonus); hp 4; MV 12; ML 11; AL NG. S 9, D 16, C 10, I 12, W 10, Ch 14. Thief skills: PP 20%, OL 25%, F/RT 15%, MS 50%, HS 40%, DN 15%, CW 70%, RL 0%. Personality: Helpless, frightened.

**Sardo (human form) (F6):** THAC0 15; Dmg 1d8 (long sword); AC 9 (Dex bonus); hp 47; MV 12; ML 14; AL CG.

S 15, D 15, C 13, I 10, W 8, Ch 11.

Personality: Protective, sly.

**Sardo (half-wolf form):** THAC0 15; Dmg 2d4 (bite) or 1d8 (long sword); AC 5; HD 4+3; hp 35; MV 15; SA 2% chance per hp of bite damage that victim becomes infected with lycanthropy; SD +1 or better weapon to hit; MR nil; SZ M; Int avg; AL CE; ML 12; XP 420.

### Entering the Maw

**T**he Maw of Arawn (point G on the map on page 32) lies in a fissure on top of a 4,500-foot-high mountain peak. PCs starting out from the lowest point in the domain face a 4,000-foot climb; even for those already on the slopes of the mountains, the climb will involve the better part of a day. The DM is invited to make the climb as challenging as possible.

The fissure itself runs for one mile in a north-south direction and is roughly 500 feet wide. Its edge is a sheer, crumbling cliff. Those who approach within 10 feet of the edge must make a successful Dexterity check with a -2 penalty or slip on loose rock and tumble into the chasm, suffering 5d6 damage from a 50-foot fall, plus another 1d6 damage from landing on sharp bones below. Of course, the use of rope is just one means to avoid such an accident.

The only safe entrance into the Maw lies at the midpoint along the western edge. To reach it, the PCs must move treacherously close to the edge of the cliff (Dexterity checks required with a -4 penalty) and then work their way around a stone outcropping. From there, the path works its way into the Maw, switching back and forth every 50 feet on the steep face.

Anyone within 100 feet of the fissure enters a sickly yellow mist that surrounds and obscures it. Upon first contact, characters must successfully save vs. poison or suffer intense dizziness. Those who fail their saving throws

## MUSIC OF THE MISTS

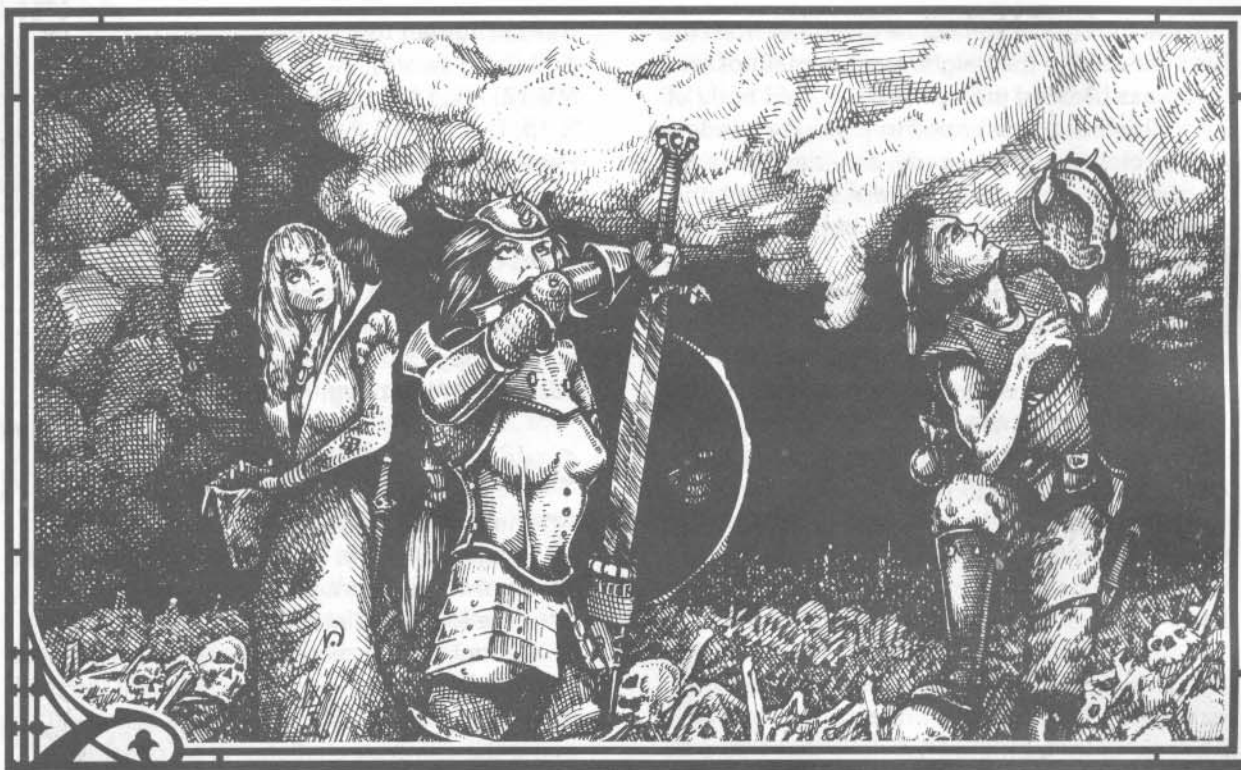

temporarily lose 2 points of Dexterity and suffer a further penalty of -2 on their attack rolls for as long as they remain within the mist.

Inside the Maw it is difficult to see. The yellow vapor swirls and eddies as it flows up from the fissure, alternately revealing and concealing what lies within. Visibility is restricted to 20 feet. Even infravision is affected—the mist is uncomfortably warm.

### Into the Valley of Death

The floor of the fissure is a flat, relatively level area about 400 feet wide and half a mile long. It is littered with thousands of bones, all stained a vile yellow color by the mist that rises from the ground. The bones, many of which are broken into sharp shards, reduce the PCs' movement by half. If the bones are kicked or brushed aside, the ground they rest upon will be found to be of porous stone (heated and cooled repeatedly until it has reached that state), through which the yellow vapors rise.

A mist horror has been trapped here for some time. It takes the vaguely humanoid form of a ghost and attacks the weakest character.

**Mist Horror:** THAC0 15; #AT 2; Dmg 2d6/2d6; AC 2; HD 5; hp 39; SA surprise attack on first round; SD able to disperse (become invisible) at will (requiring 1d4 turns to reform), +2 or better weapon to hit; MR 50% (20' radius of effect, spells only—items work normally); SZ M; Int low; AL NE; ML 12; XP 3,000.

Mist horrors can be turned as "special" undead.

### The Guardian

**B**efore the *horn* can be recovered, the PCs face one more battle. Guarding it is a bone golem that attacks when the artifact is touched. The golem fights to the death to prevent the *horn* from being taken. Note that the golem rises up *behind* the PCs—the skull in



## MUSIC OF THE MISTS

whose teeth the *horn* is found (see below) is not part of the golem.

The yellow vapors swirl around you, shrouding the sky. The sun is no more than a dim blob of light overhead. The vapor rising from the ground makes you feel as if you might faint. Ghastly skulls underfoot stare up at you with lifeless eye sockets, as if they were watching your every movement.

Suddenly, you hear a faint noise off to your right. It sounds like the low moan of a horn. Then the yellow vapors part momentarily, and you see what produced the eerie noise: A brightly polished horn carved from an antler, trimmed with gold and studded with glittering crystals, lies on the ground amid the scattered bones. The mouthpiece is held between the grinning teeth of a human skull. You pause, considering the gruesome sight. Did the skeletal head somehow sound the horn? Then a faint breeze blows, and the horn moans once more. Apparently, it was only the wind.

If the PCs were directed to the Maw of Arawn as a result of the "Shattered Secrets" encounter, they should recognize the *horn*.

The golem was not intended to be a guard for the *horn*, but it wandered into the fissure and has made this place its home. It also has claimed the artifact as its own, even though it cannot use it, and the golem will fight anyone who tries to remove it, including druids.

**Bone Golem:** THAC0 7; Dmg 3d8 (fist); AC 0; HD 14; hp 70; SA hideous laugh (1/3 rounds) forces all who hear it to make successful fear and horror checks or be paralyzed for 2d6 rounds (failing both checks results in instant death); SD +2 or better weapon to hit, edged and piercing weapons inflict only half damage; MR special (see below); SZ M; Int non; AL N; ML 20; XP 18,000.

Golems are immune to most magic. However, if a *shatter* spell is focused upon one and it fails a

saving throw vs. spell, then weapons are able to inflict twice their previous damage (i.e., edged weapons inflict full damage while blunt ones inflict double-damage). If *dispel magic* is cast upon a bone golem, it collapses and appears to be destroyed for a number of rounds equal to that of the caster's level. A *detect magic* spell will reveal that the golem is not actually destroyed, but is gaining power as it "recharges." If the caster is 10th level or higher, then the *detect magic* destroys it permanently.

### Complications

- For each 10-minute period spent within the yellow vapors, PCs must save vs. poison. Failure results in a cumulative loss of 2 points of Dexterity (from dizziness) and a cumulative penalty of -2 to attack rolls (-8 max). All penalties subside at the rate of 1 point per hour after leaving the mist. The debilitating effects of the yellow vapor can be negated immediately with a *heal* spell. Spells of protection vs. poison do not help.

### Resolution

If the PCs are accompanied by Maeve and Shelaugh, the druids will insist upon taking the artifact back to Sanctuary for study, where they will begin to unlock its secrets.

If the PCs have discovered the *horn* on their own, they face two problems. The first lies in the corrupting effects of the artifact, and the second arises from the fact that Tristen can sense the existence of this new and powerful item as soon as it is removed from the Maw of Arawn. As long as they keep it, the PCs will be plagued by a series of attacks by goblins and zombie wolves.

It is unlikely that the PCs will be able to properly use the *horn*. If blown, there is a 5% chance per attempt that a random one of its powers will be triggered in a wild and uncontrolled fashion (if possible). If the person who has blown the horn makes a successful Wisdom check, the effect can be repeated and controlled.

## A BITTER HARVEST



A

*h, thought I, thou mourn'st in vain,  
None takes pity on thy pain.  
Senseless trees, they cannot hear  
thee;  
Ruthless beasts, they will not  
cheer thee.*

—England's Helicon

This encounter is set in the ruined village of Birnam, and it introduces the PCs to a monster unique to Forlorn: the death's head tree (see page 94 of *The Weeping Land*).

Note that Flora ApBlanc's nightly run to the sacred grove begins in Birnam. If this encounter occurs at night, the Dungeon Master may choose to follow this

adventure with that haunting.

### Background

There is little left of Birnam, having been burned by Tristen and looted by the goblins who once called it home. The only building in the entire village that remains even partially intact is ApFittle Hall, home to Tristen's rival ruling family before Forfar was transported to the demiplane of dread.

In the year 1930, ApFittle Hall was burned until only its charred skeleton remained. Within its smoking ruins, 27 members of the ApFittle family—men, women, and children—were put to death under the swords of Tristen ApBlanc's mercenaries. This mass execution heralded the beginning of the "Time of Terrors," which ended in Forfar's removal to Ravenloft.

In the blood-saturated soil within the remains of ApFittle Hall, the seed of a new abomination germinated when it passed through the Mists; a *death's head tree* took root and thrived in that site of carnage. Fifty-two years later, the tree produced its first crop of heads. When the PCs encounter it, the tree is in full fruition.

The only remaining inhabitants of Birnam are gremishkas—the offspring of Birnam's dogs and

cats, now transformed into monsters of Ravenloft (see the RAVENLOFT® boxed set). They are very intelligent and even more greedy. They love glittering trinkets in particular. ApFittle Hall is home to 16 of them.

### Setup

As the PCs explore the ruins of Birnam, there's a scuttling noise among the tumbled stones and blackened roof beams every now and then. Soon, the PCs catch a glimpse of a gremishka in the remains of a house.

A creature about the size of a large cat grins at you from the darkness of a crevice in a broken wall. With its pointed ears erect and its tail lashing from side to side, it surveys you with bright eyes. The little beast sits in a hunched position with its elbows on its knees and its mouth set in a needle-toothed grin. One claw clutches the partially gnawed carcass of a rat. The creature's eyes dart from one of you to the next as it emits a chittering noise.

One by one, the rest of the clan members poke their heads out of various nooks and crannies, chattering to each other like a pack of prairie dogs. They pretend to befriend the PCs, acting cute (as cute as gremishkas can!), frolicking, and edging in close to tug at a character's leg, as if it would beg for a morsel to eat.

When the time is right, the gremishkas swarm the PC who wears the most jewelry. Half of them grab at baubles (consider a successful attack to be a successful grab) while the others bite and jeer chaotically at the PCs.

Once a gremishka gets an item, it runs away helter-skelter. The monsters should steal at least one object of great value to the PCs. The gremishkas then play a game of "keep away" with the PCs, tossing the items back and forth, running down holes with them only to reappear on the other side of the street, and thus lead the PCs to the main part of this encounter.



## A BITTER HARVEST

**Gremishkas (8):** THAC0 20 (18 for targets over 4' tall); Dmg 1d3; AC 4; HD ½; hp 4 each; SA nil; SD +4 to saving throws vs. weapons with an area of effect; MR nil; SZ T; Int very; AL CE; ML 5; XP 35 each.

The chase ends in the remains of what was once ApFittle Hall.

The little creatures, still jabbering and grinning fiercely, scamper over a crumbling wall and into the only building left standing in town. The charred structure looks like a strong wind might blow it over, but the little sneak-thieves must think they'll be safe in there.

ApFittle Hall is a single-story, 120-foot by 80-foot stone and burned-wood building, surrounded by a 160-foot by 120-foot by 10-foot stone wall. There are numerous breaks in the outer wall and at least one break in each of the inner walls, through which a PC could easily pass. The interior walls of the hall are all burned away, leaving one large room with no roof. The floor is strewn with collapsed beams and debris, but the death's head tree grows right in the center of the room.

If the PCs pursue the gremishkas into ApFittle Hall, read the next player text block.

The creatures scamper easily over the rotted, blackened beams and up into the branches of a weeping willow tree. Peeking out at you from the dark, leafy recesses, they chatter and scold, clutching your precious possessions greedily.

As you draw nearer, you quickly pull up short when you smell a horrible, rotten odor that comes from the tree. The source of the odor is quickly evident: There, hanging from the branches, are a number of severed heads.

One by one, the heads open their eyes and fix their stares upon you. They open their mouths and begin to cry piteously in the Common tongue, "Help! Help me!"

The tree bears 11 death's heads, each containing 1d6 seeds. For the moment, the tree is ignoring the gremishkas—it has been a long time since so many large, warm-blooded creatures have come this close, and the tree wants to plant as many of its seeds as possible. If the PCs close to within 30 feet, the heads begin to spit their needle-sharp seeds at them. Once the seeds are exhausted, the death's heads will attempt to bite anyone within 10 feet of the tree.

**Death's Head Tree:** THAC0 5; #AT 11; Dmg 1 (seed) or 1d4 (bite); AC 10 (trunk) or 7 (branches/heads); HD 10; hp 82 (trunk), plus 6/head; SA spits seeds up to 30'; SD immune to all forms of fire; MR 10%; SZ H; Int semi; AL NE; ML 20; XP 4,400.

See page 94 of *The Weeping Land* for details about the seeds of a death's head tree and their effect upon PCs.

### Complications

- The gremishkas attack the party while it is busy with the death's head tree.
- The death's heads detach from the tree and chase fleeing PCs.
- 4d6 goblins arrive and defend their former homes, either during the battle with the death's head tree or immediately thereafter, while the PCs are dealing with the seeds in their bodies.

### Resolution

**T**he gremishkas howl hysterically during the battle with the death's head tree, cheering whenever anyone scores a hit. If the PCs win, they drop the items they stole from the PCs and run away, seeking holes to hide in.

If any of the PCs were struck by seeds from the death's head tree, they face the nasty possibility of a death's head tree seedling sprouting inside their body (see *The Weeping Land*). Fortunately, the druids of Forlorn know how to remove and destroy these seedlings.

# MAP OF FORLORN

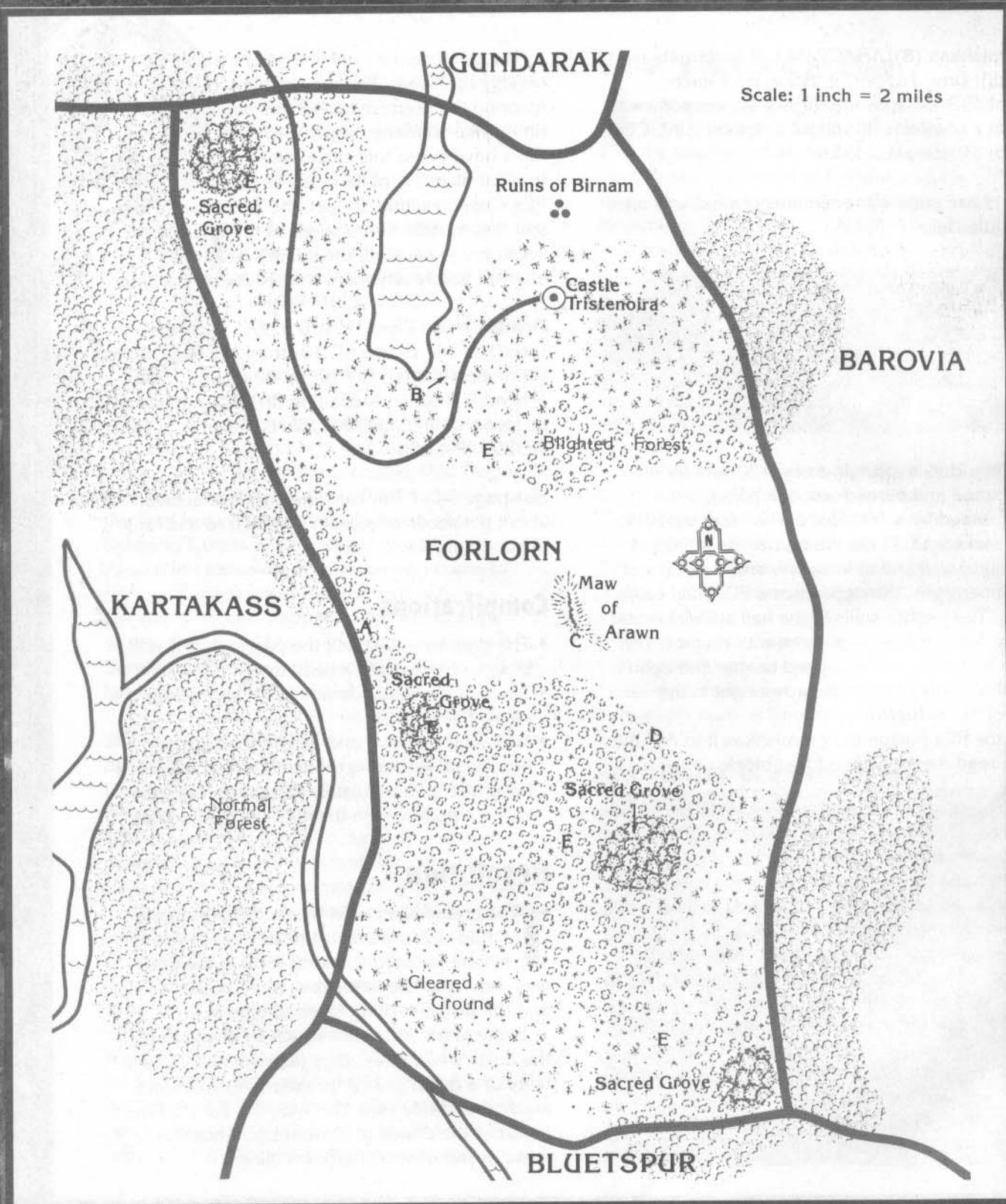





1088XXX1902

ADVANCED DUNGEONS & DRAGONS, AD&D, and RAVENLOFT are registered trademarks owned by TSR, Inc.  
The TSR logo is a trademark owned by TSR, Inc. ©1993 TSR, Inc. All Rights Reserved. Printed in the U.S.A.



**TRAVE**

**GUNDARAK**

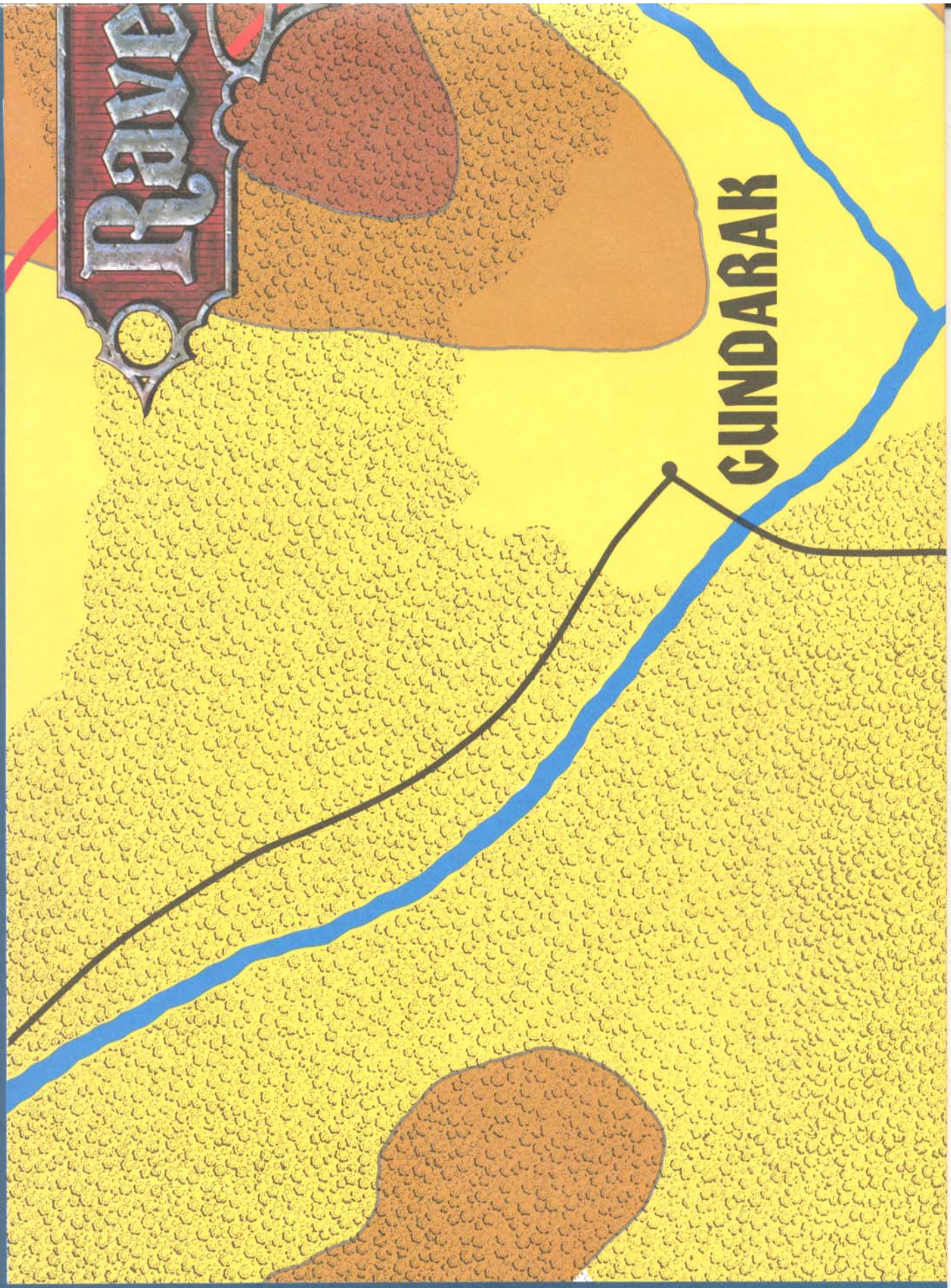



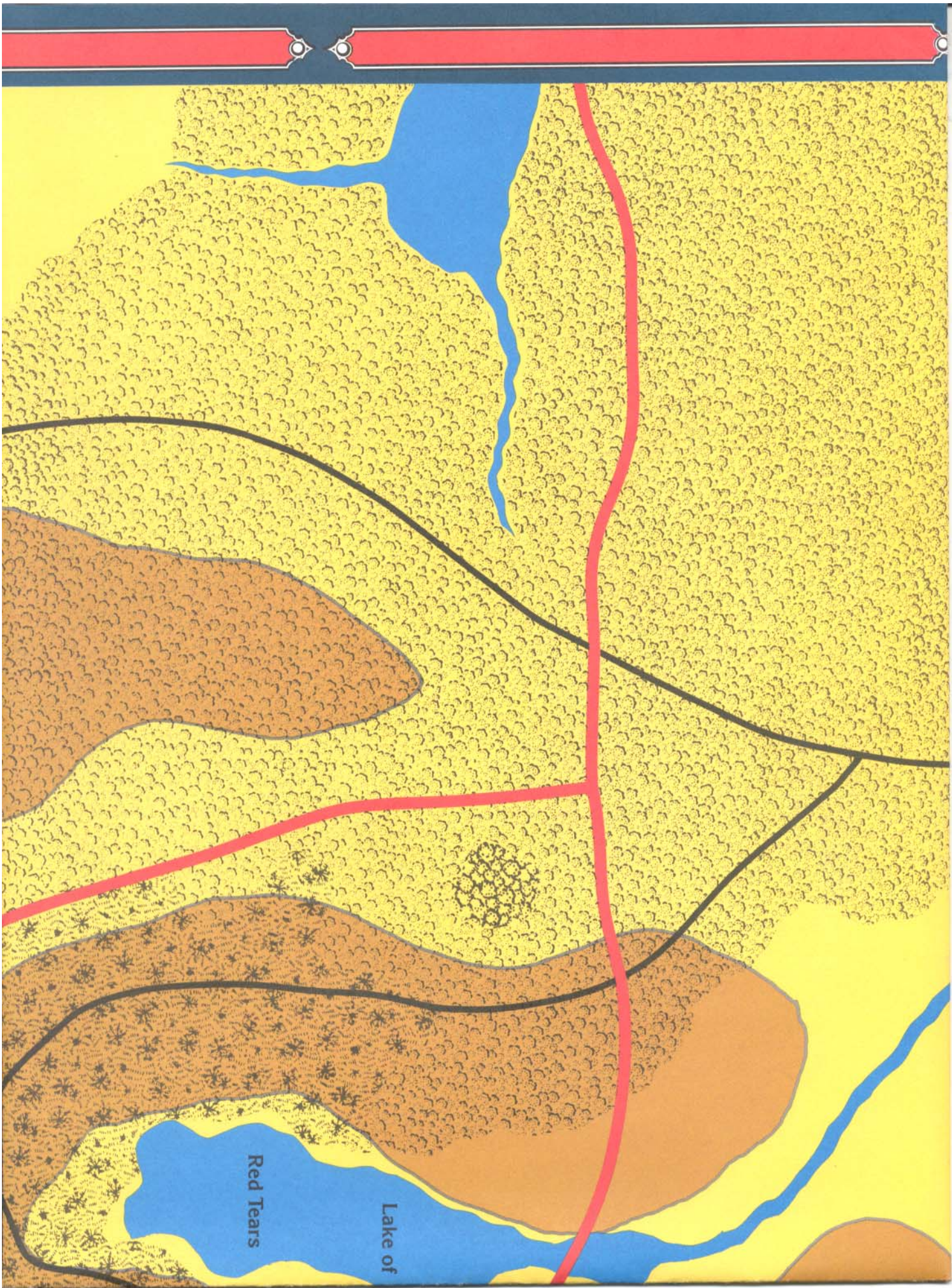



# Wolft

Official Game Adventure

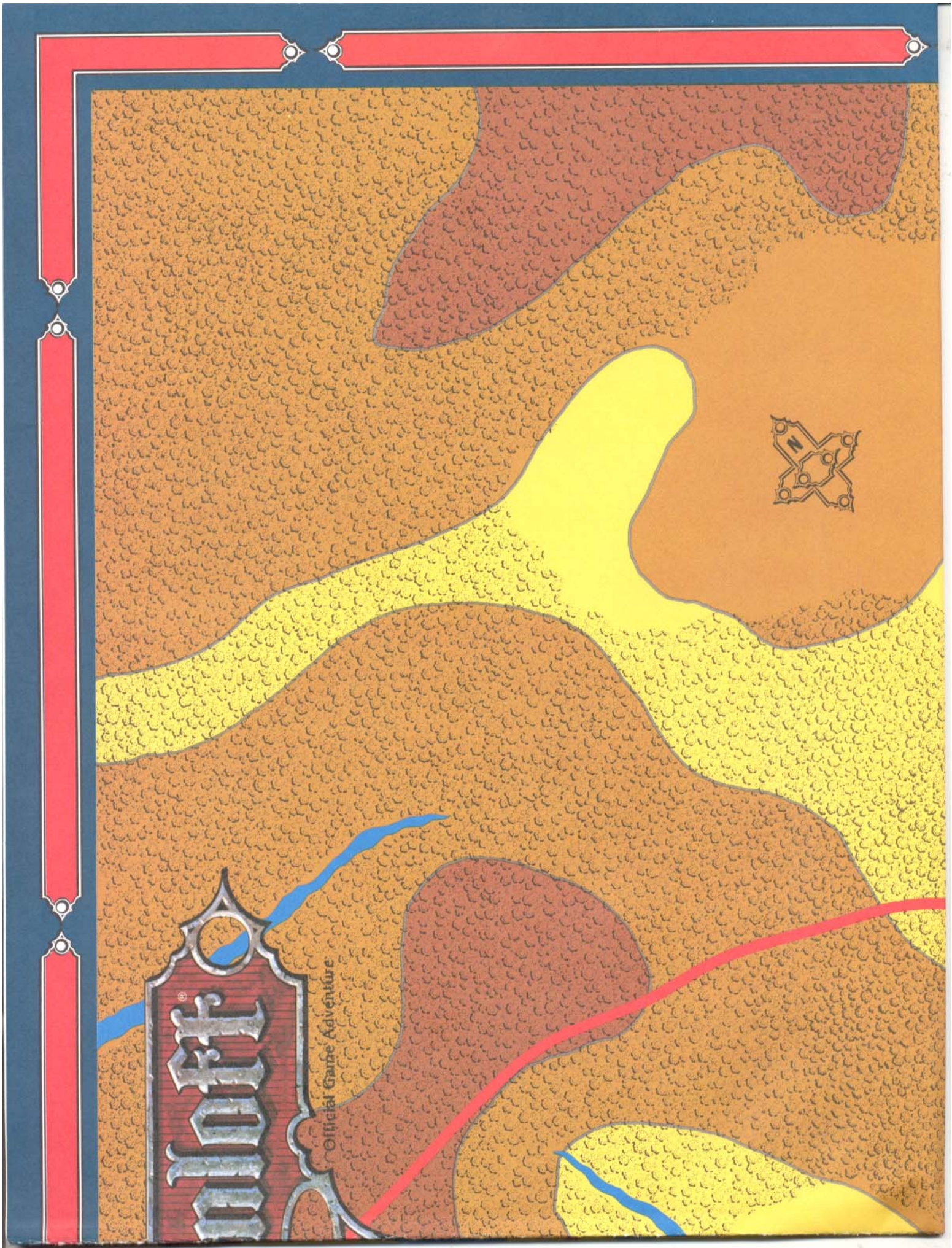



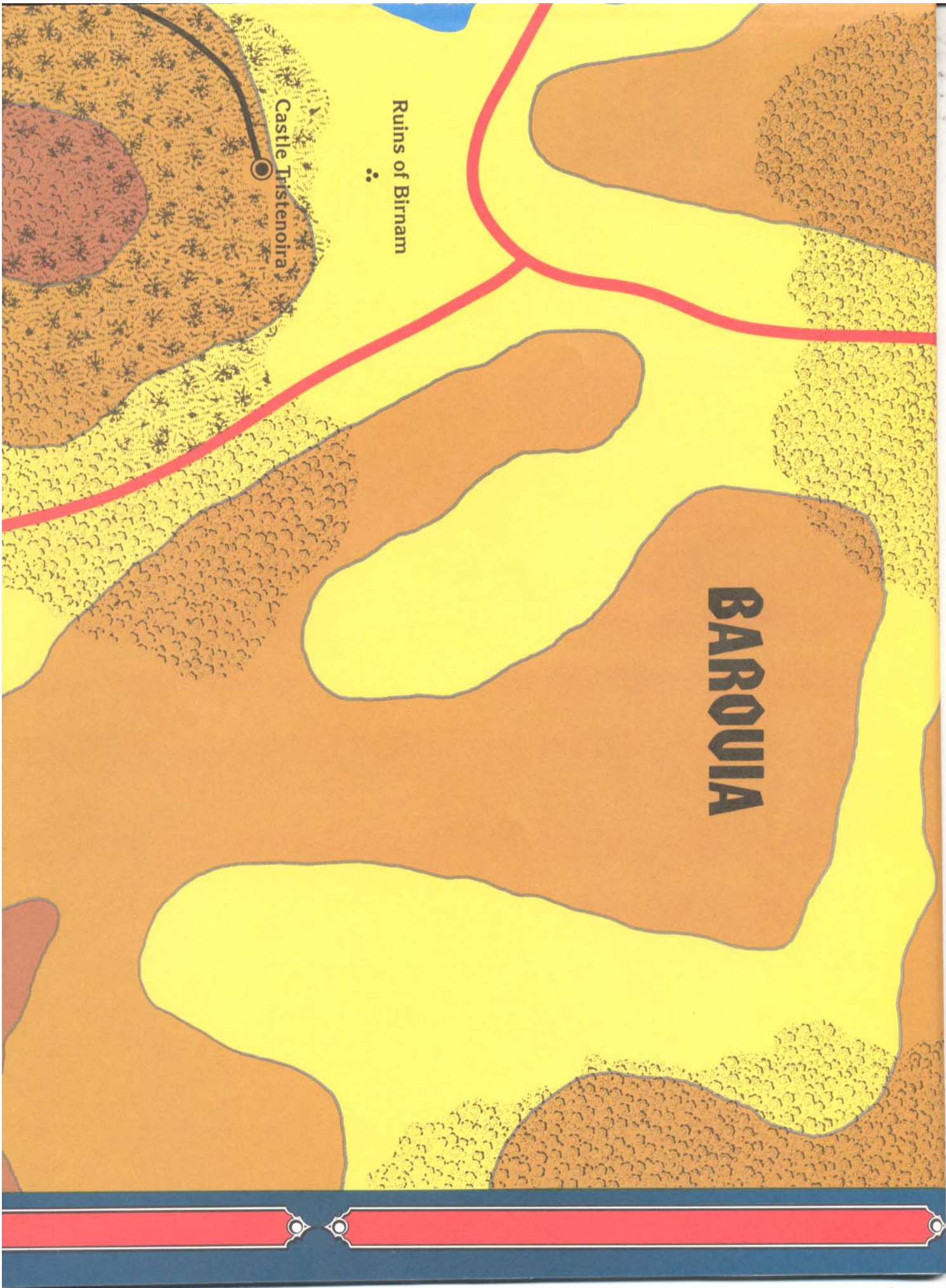

Castle Tristennoira

Ruins of Birnam

**BAROUIA**



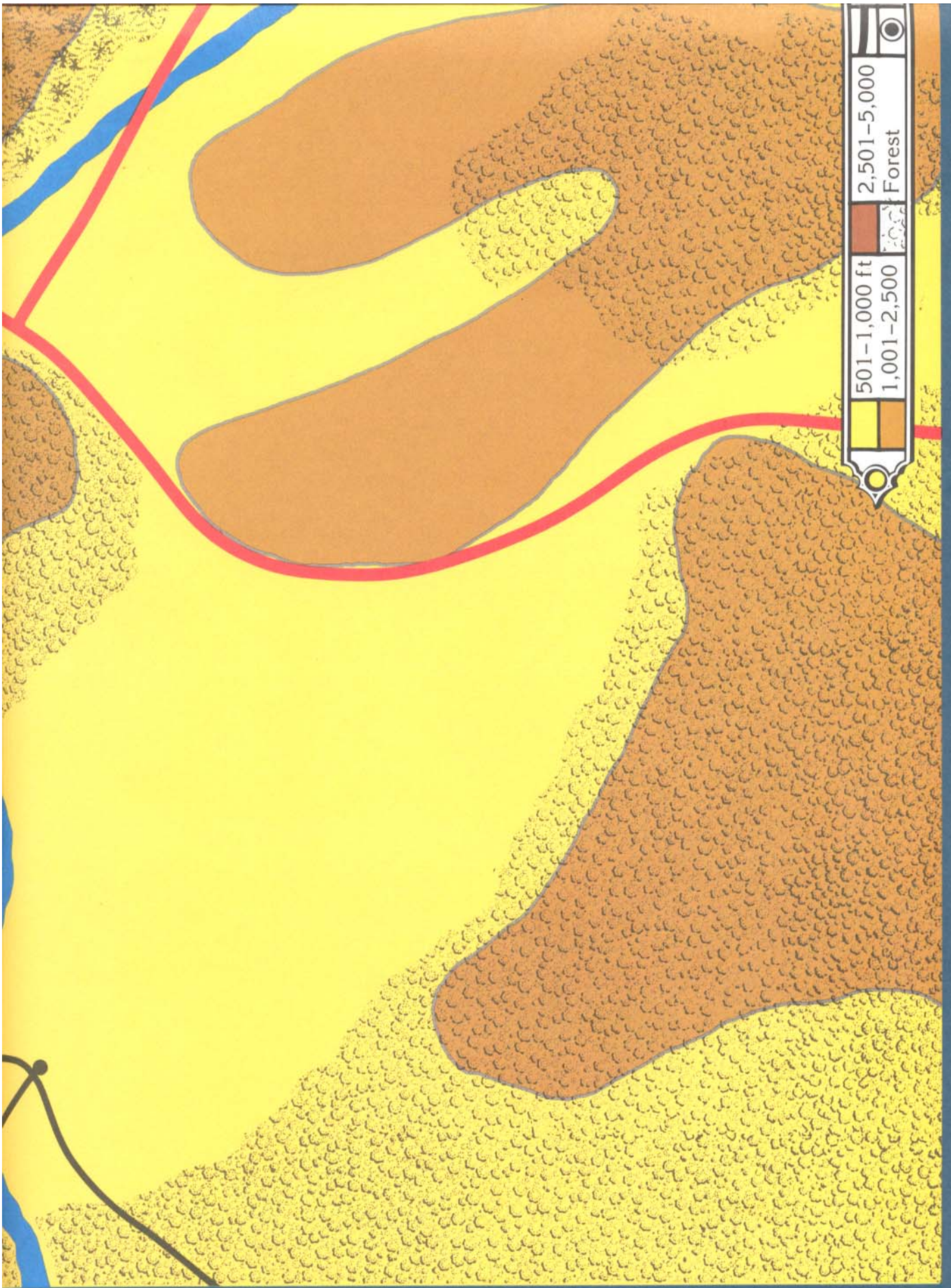





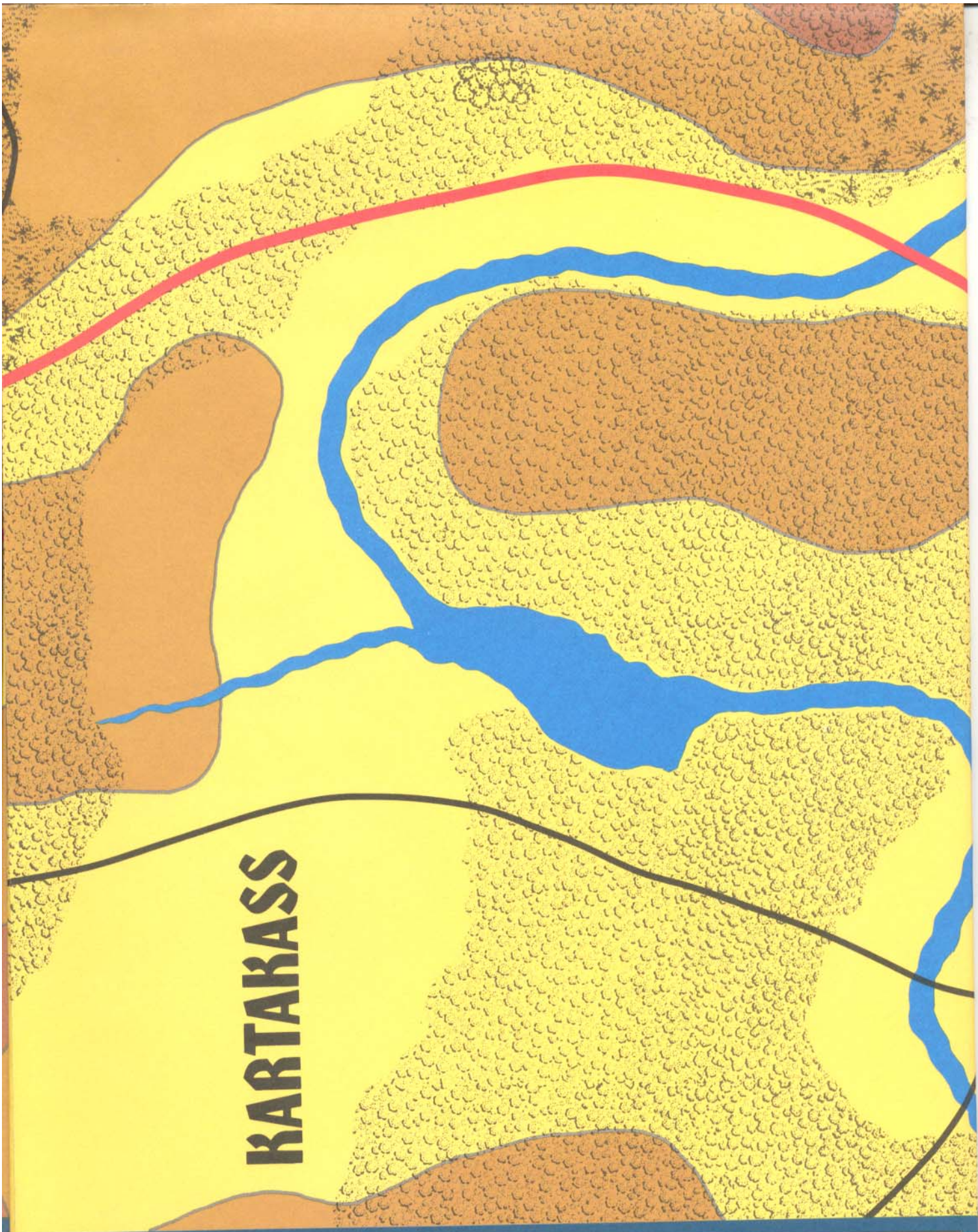

# KARTAKASS

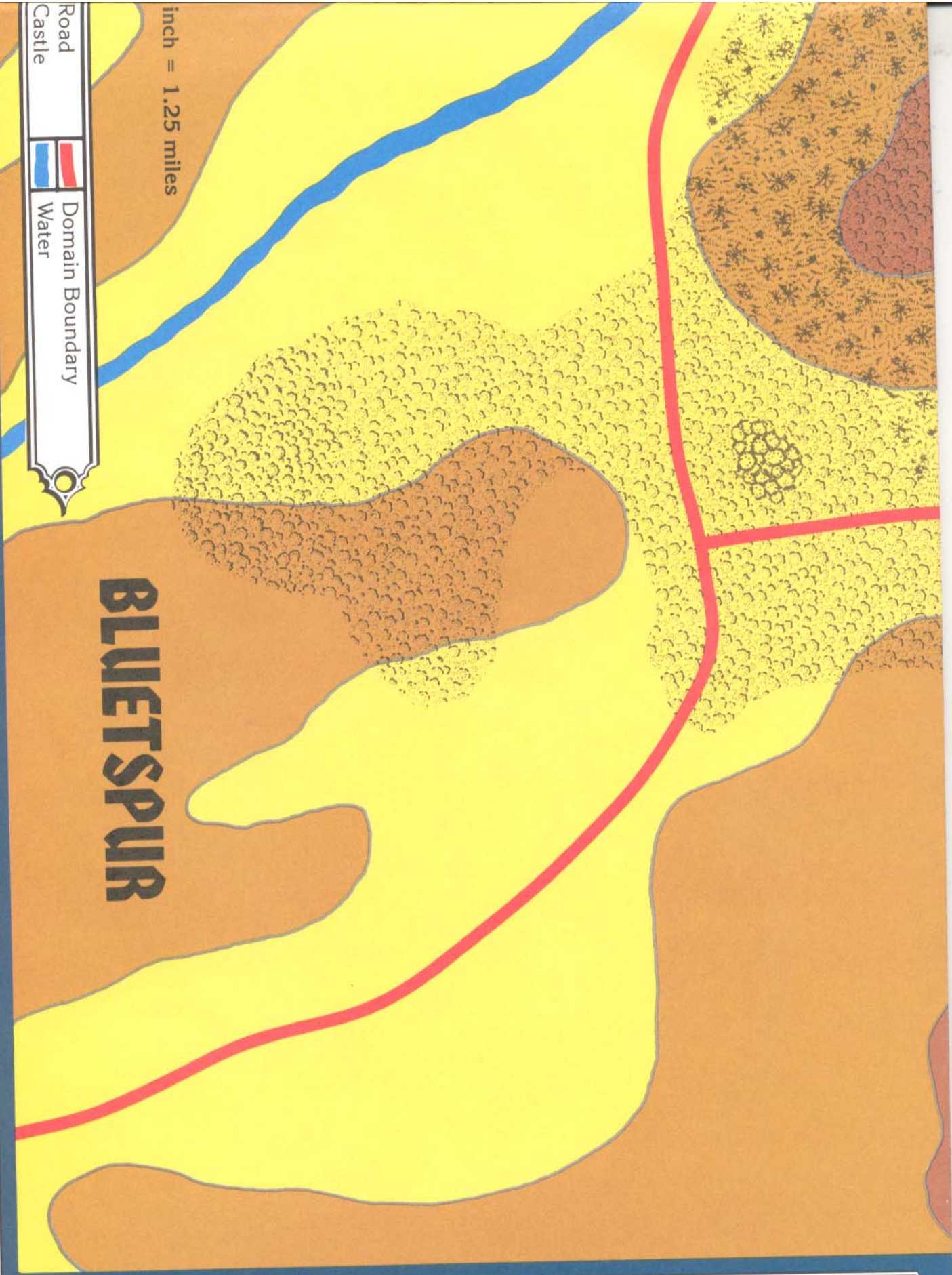





1 inch = 1.25 miles

	Road
	Water
	Domain Boundary

# BLUETSPUR

RAVENLOFT is a registered trademark owned by TSR, Inc.



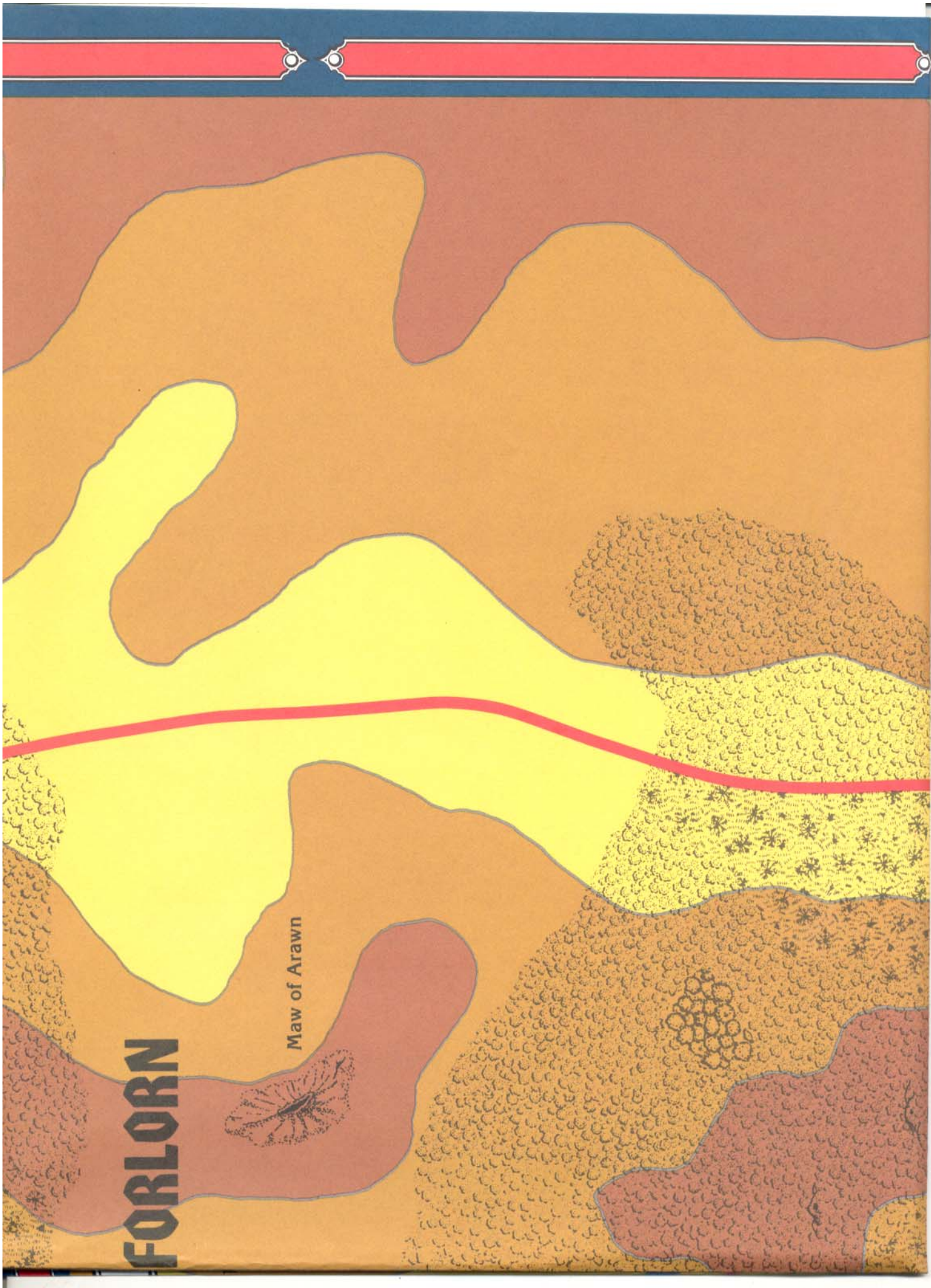

**FORLORN**

Maw of Arawn



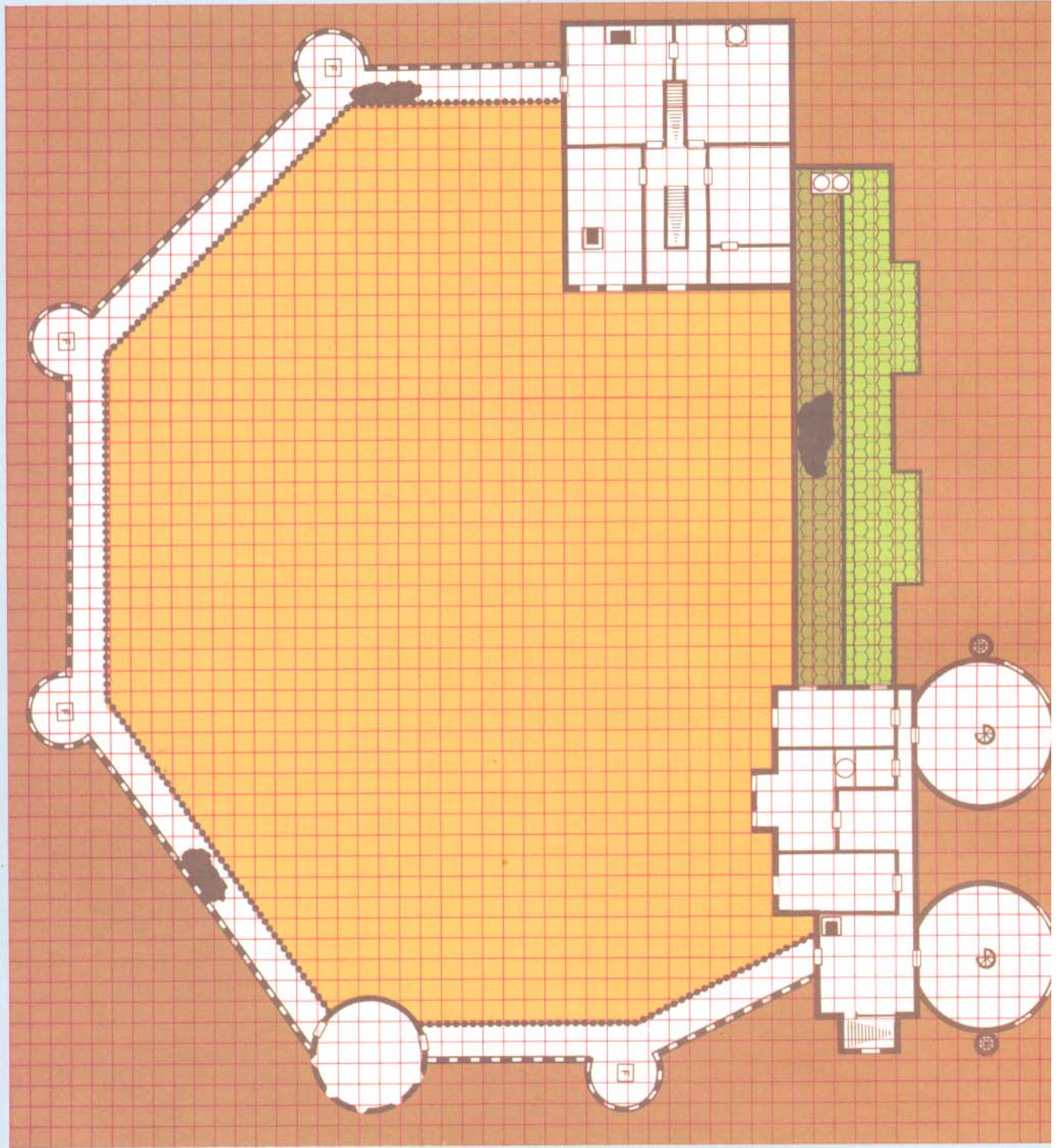



# Castles of Orln

square = 5 feet

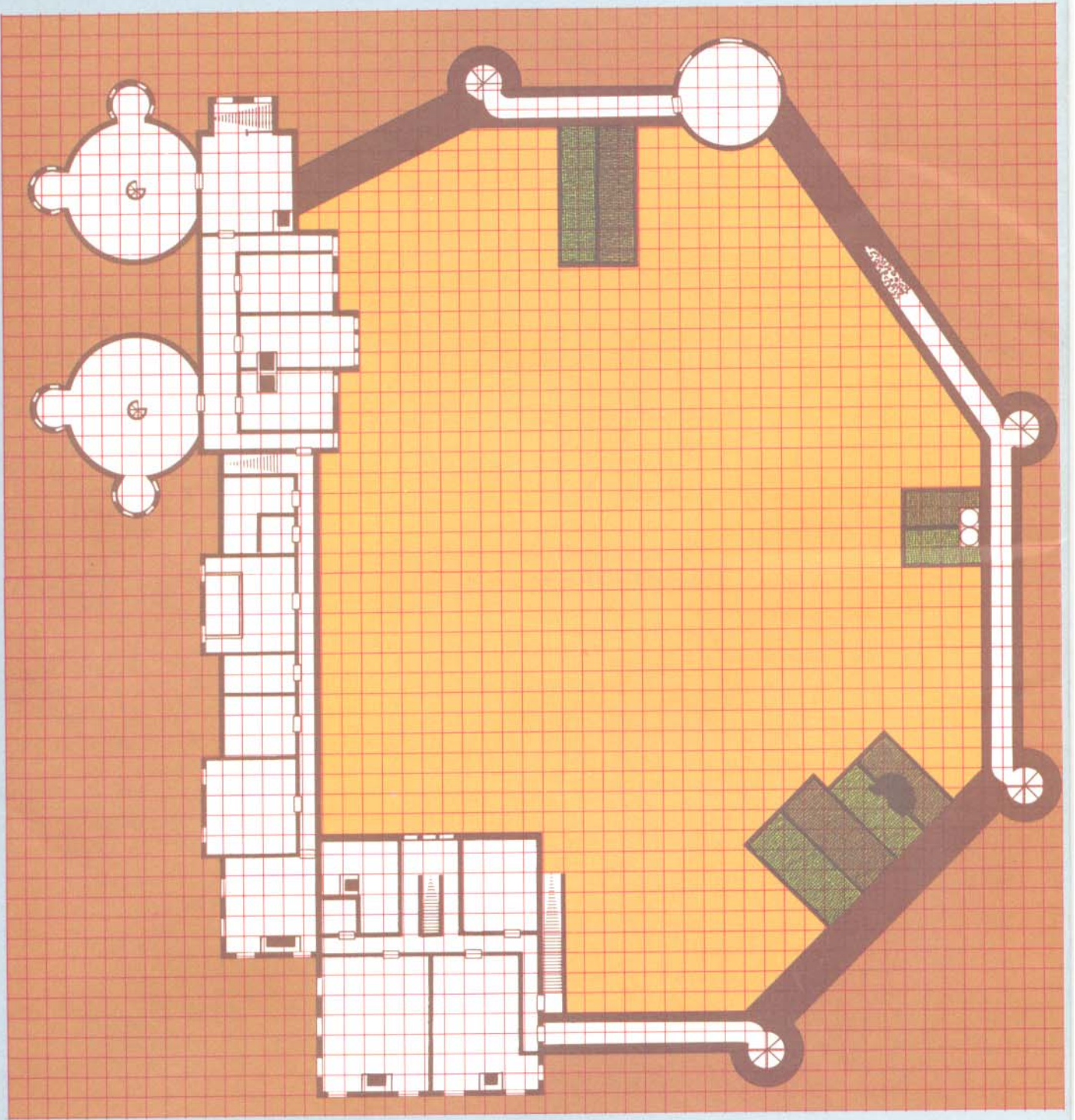



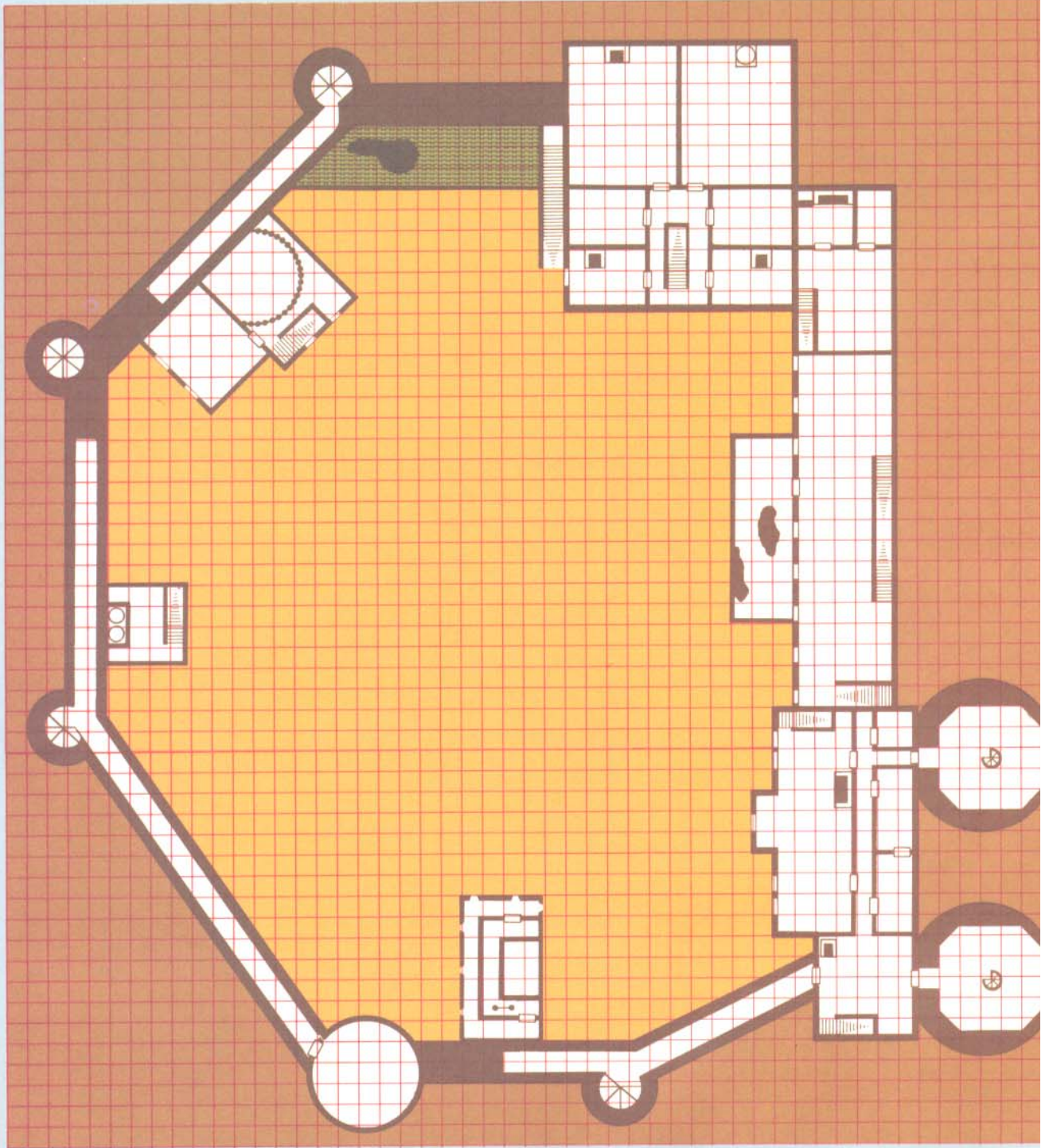



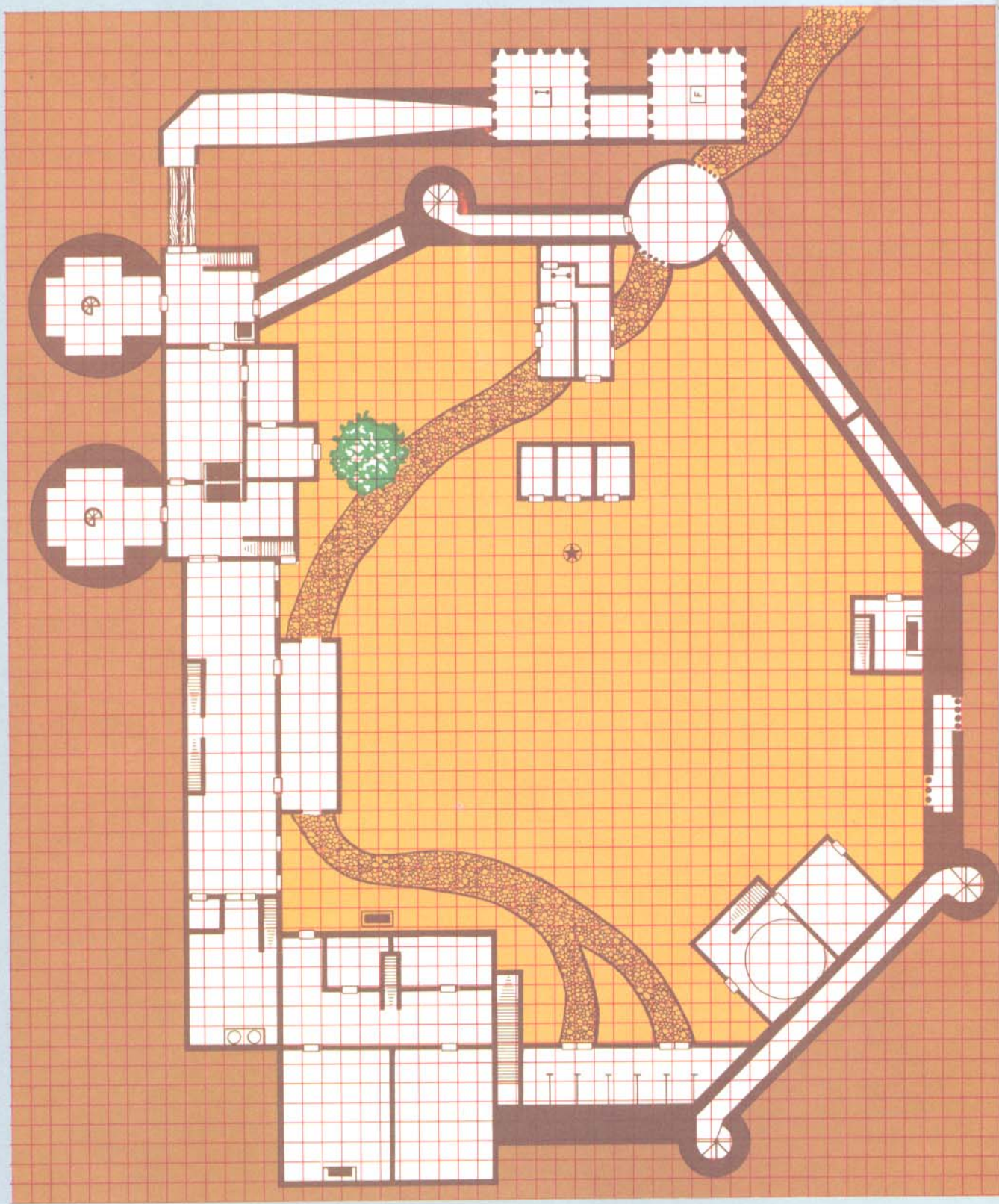















	Foot Stool
	Ladder
	Night Stand
	Rug
	Sarcophagus
	Secret Door
	Spiral Stairs
	Stairs
	Table
	Temporal Trigger
	Wardrobe
	Weapons Rack

# 4TH LEVEL

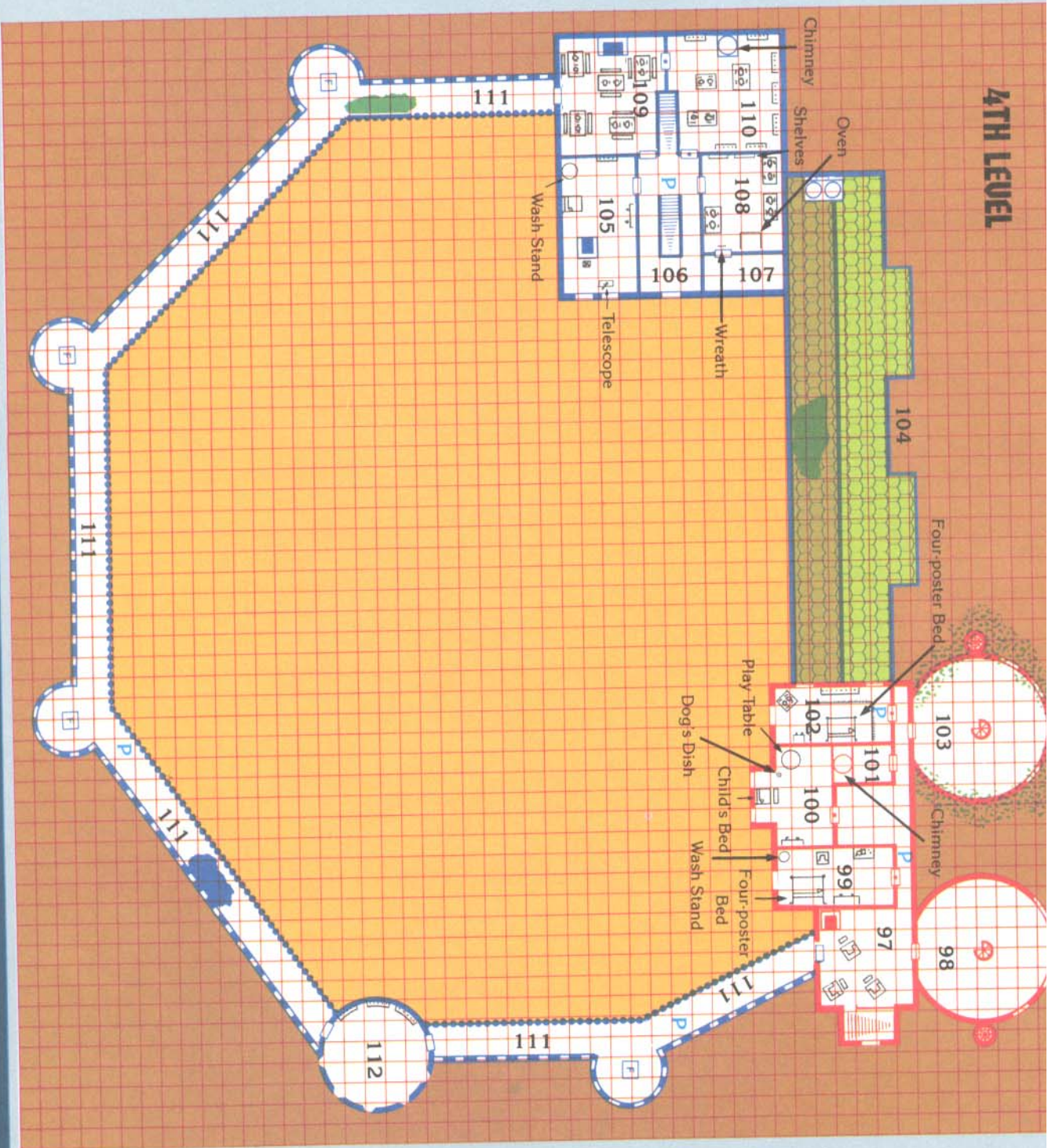



# Castles of Orlorn

1 square = 5 feet

## 3RD LEVEL

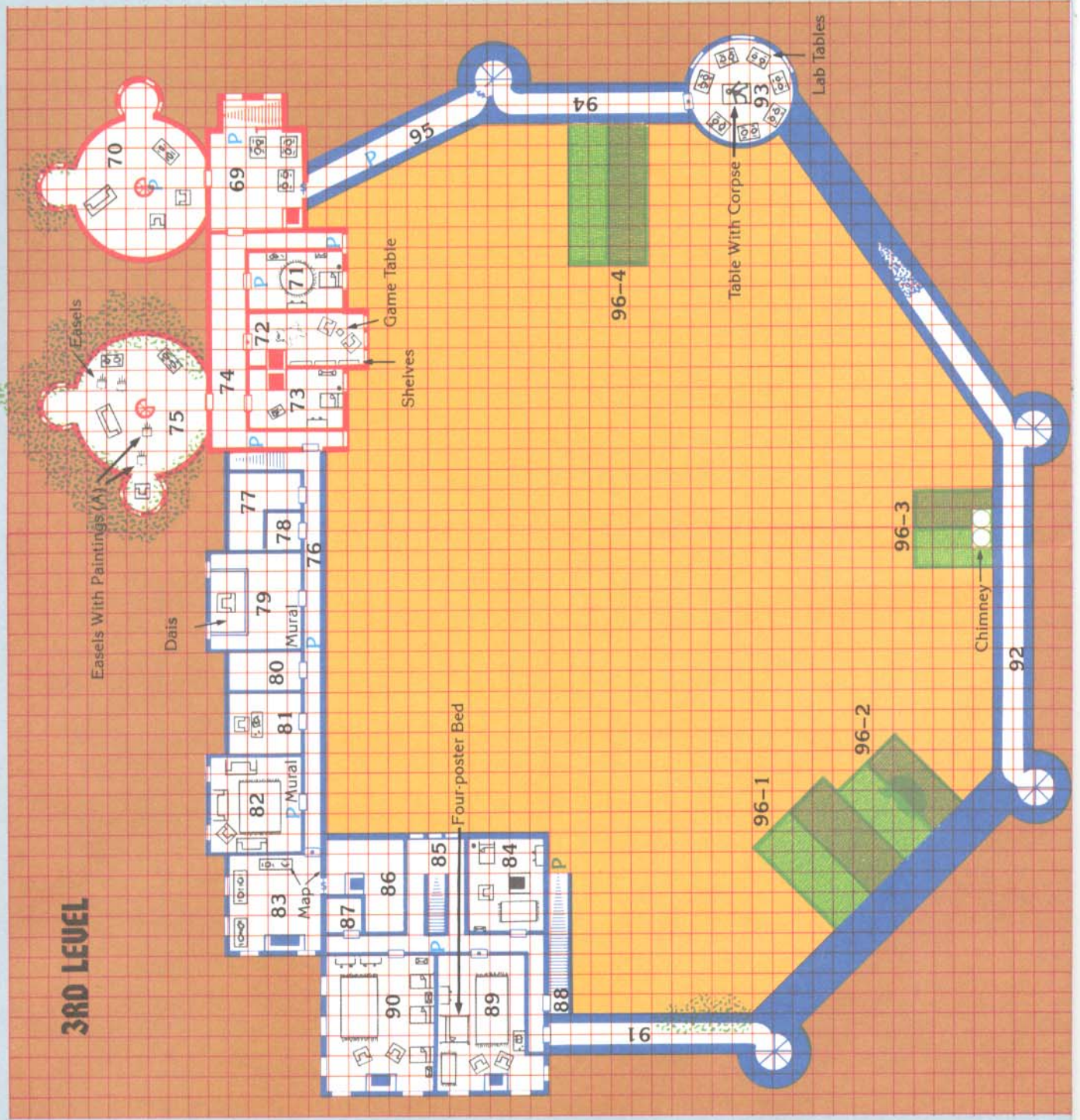

Castle A (The Lord's Tower):  
Red









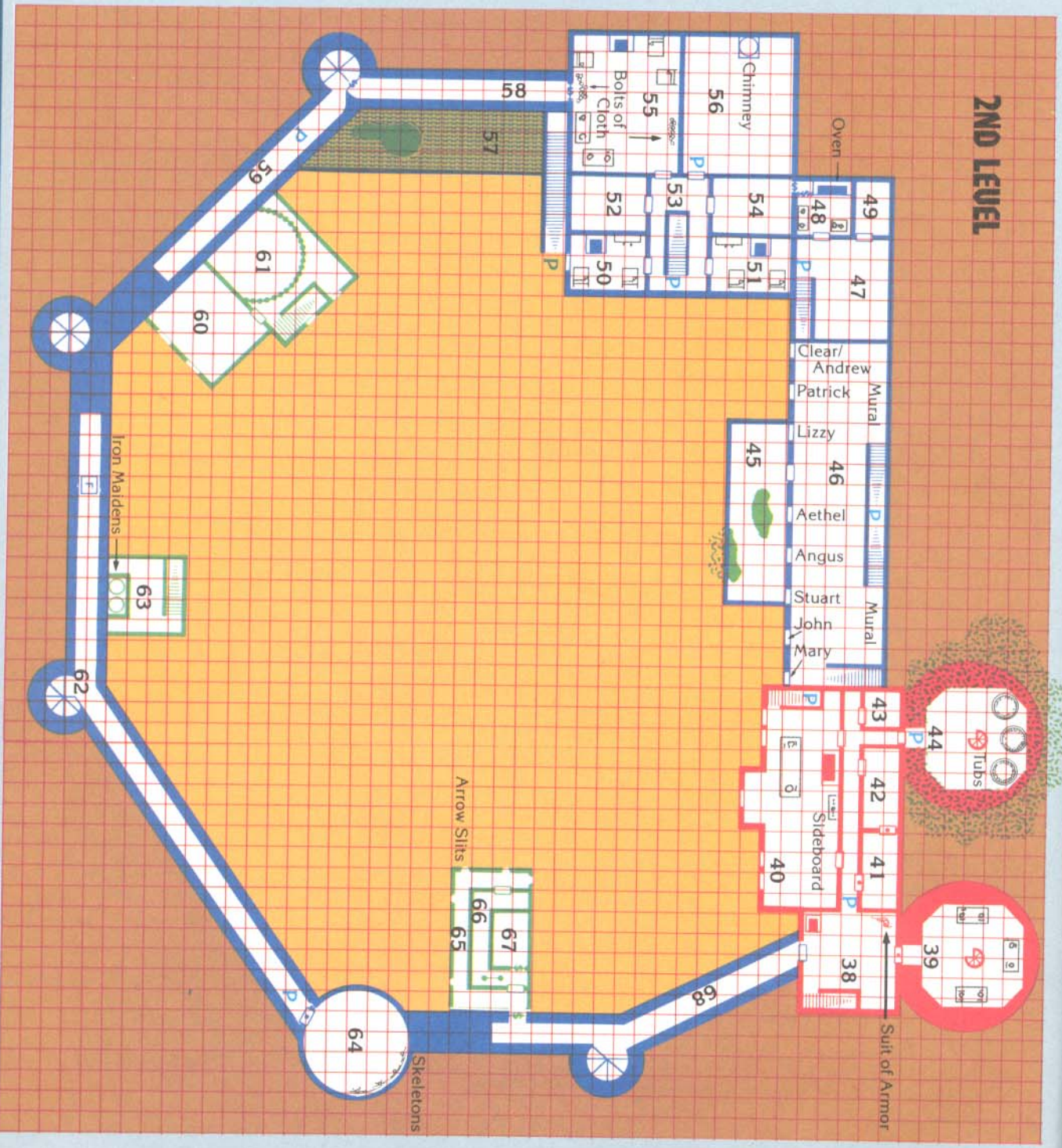



Castle B (Castle ApBlanc):  
Blue

Castle C (Castle Tristenoir):  
Green



# 2ND LEVEL



-  Bed
-  Bench
-  Chair
-  Chest
-  Couch
-  Desk
-  Door, Ceiling Trap
-  Door, Floor Trap
-  Door, Locked
-  Door, Open
-  Double Doors
-  Fireplace





GROUND LEVEL

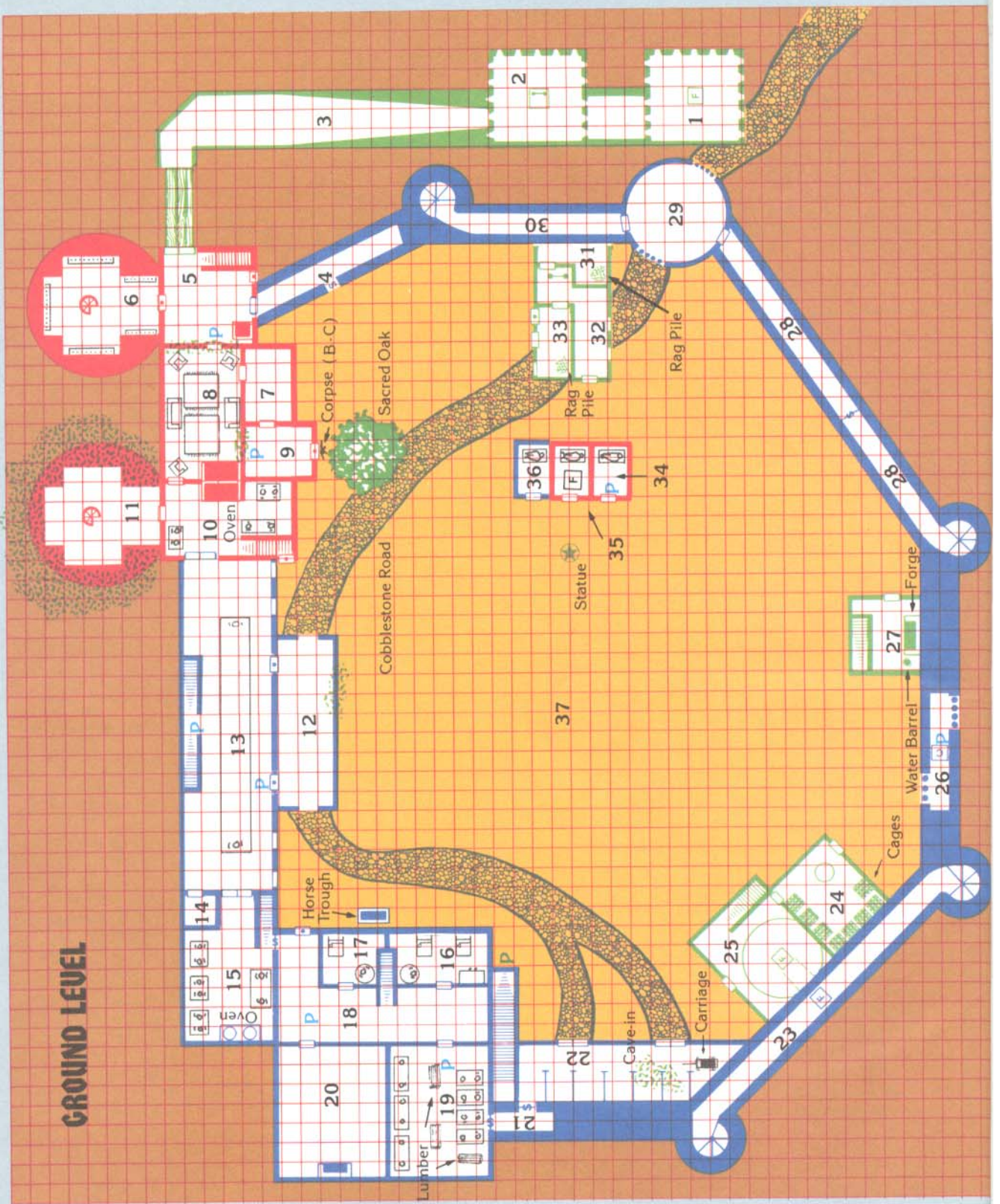



	Bed		Foot Stool
	Bench		Ladder
	Chair		Night Stand
	Chest		Rug
	Couch		Sarcophagus
	Desk		Secret Door
	Door, Ceiling Trap		Spiral Stairs
	Door, Floor Trap		Stairs
	Door, Locked		Table
	Door, Open		Temporal Trigger
	Double Doors		Wardrobe
	Fireplace		Weapons Rack

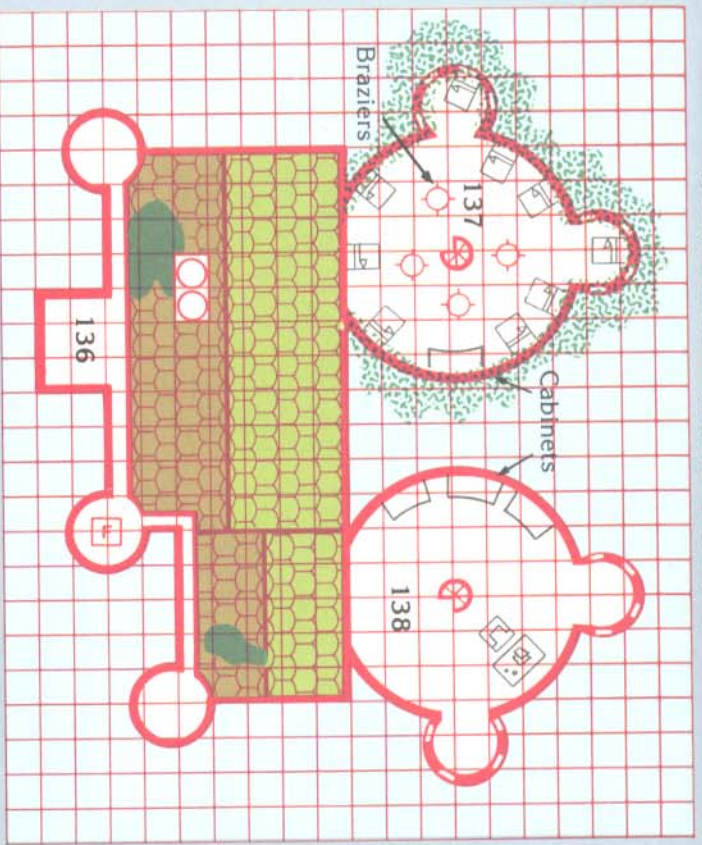

7TH LEVEL — LORD'S TOWER

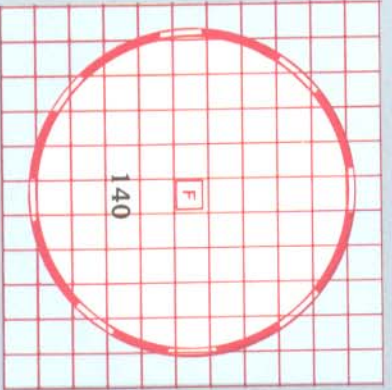
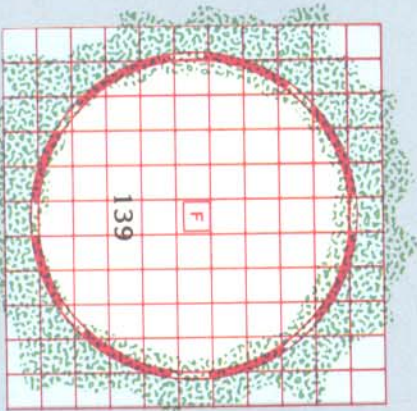

8TH LEVEL — LORD'S TOWER

Red  
Blue  
Green



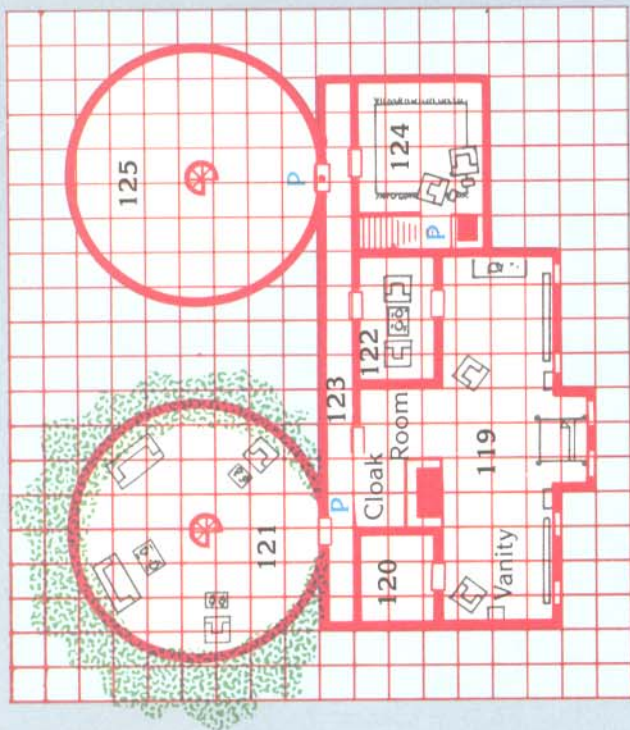

**5TH LEVEL—LORD'S TOWER**

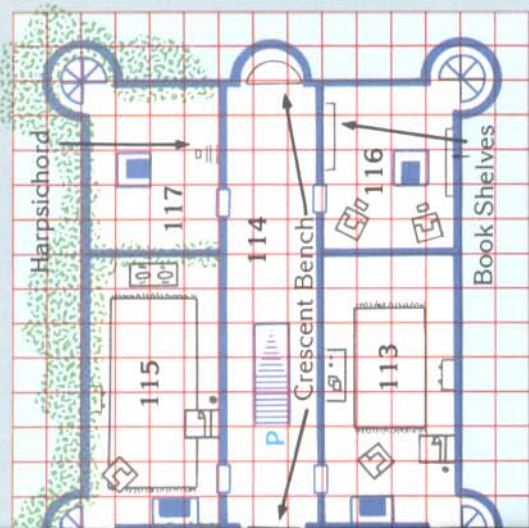
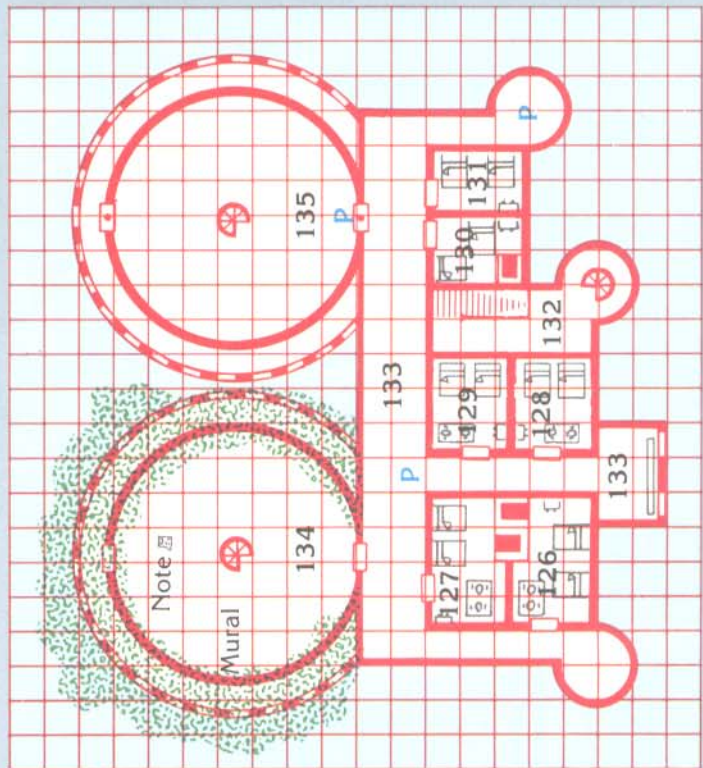

**5TH LEVEL—QUEST TOWER**

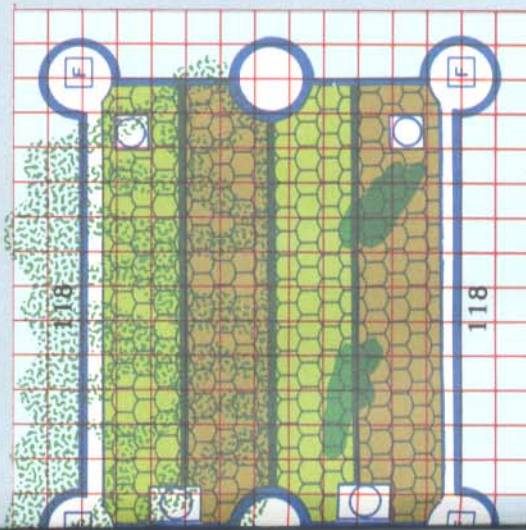

**5TH LEVEL—QUEST TOWER**



# Castles Forlorn

1 square = 5 feet



Castle A (The Lord's Tower)

Castle B (Castle ApBlanc), E

Castle C (Castle Tristenoir)

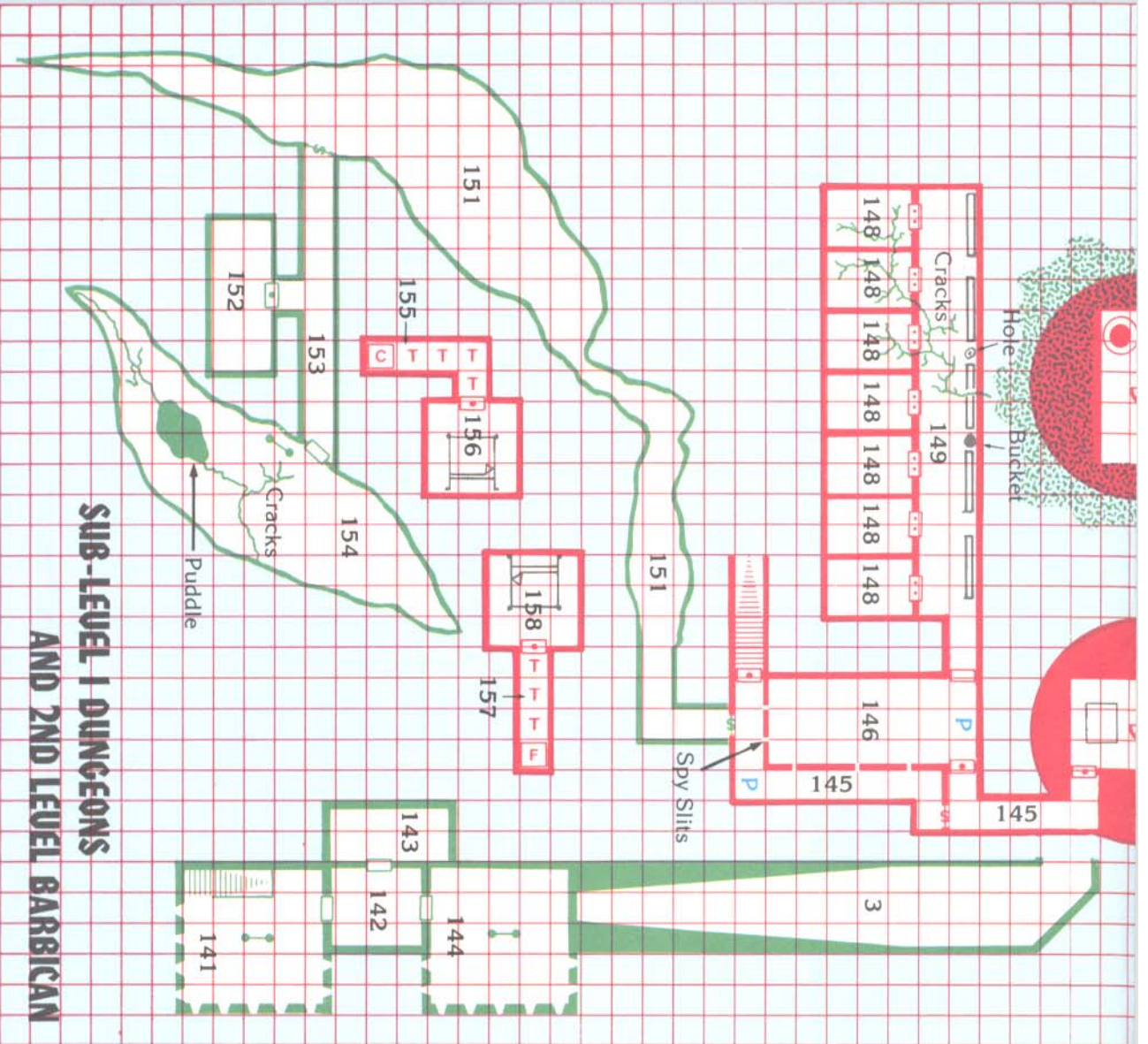

## SUB-LEVEL 1 DUNGEONS AND 2ND LEVEL BARRICAN



# SUB-LEVEL 2 DUNGEONS AND 1ST LEVEL BARRICAN

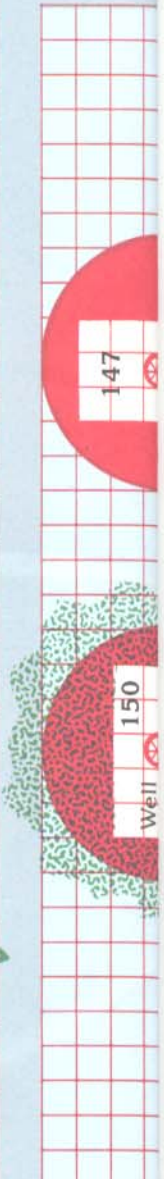
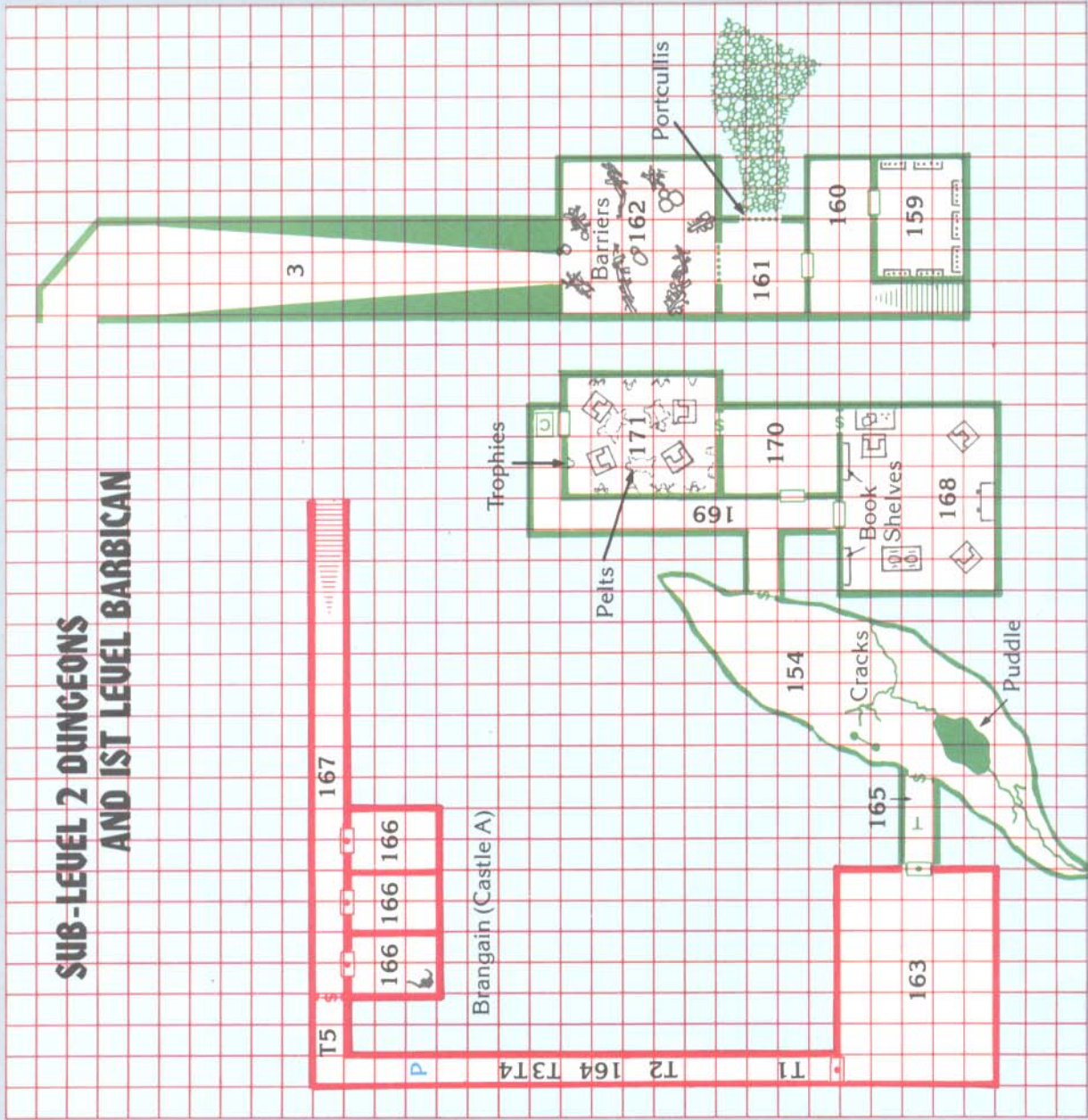

1 square = 5 feet

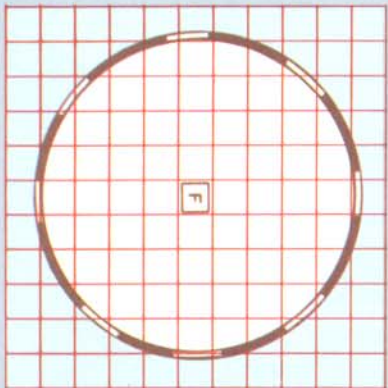
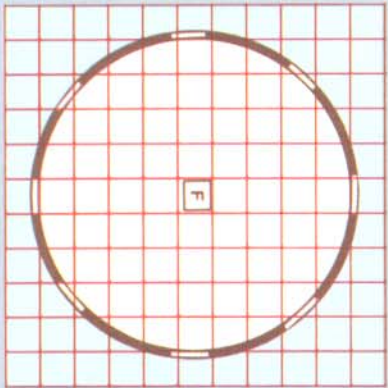
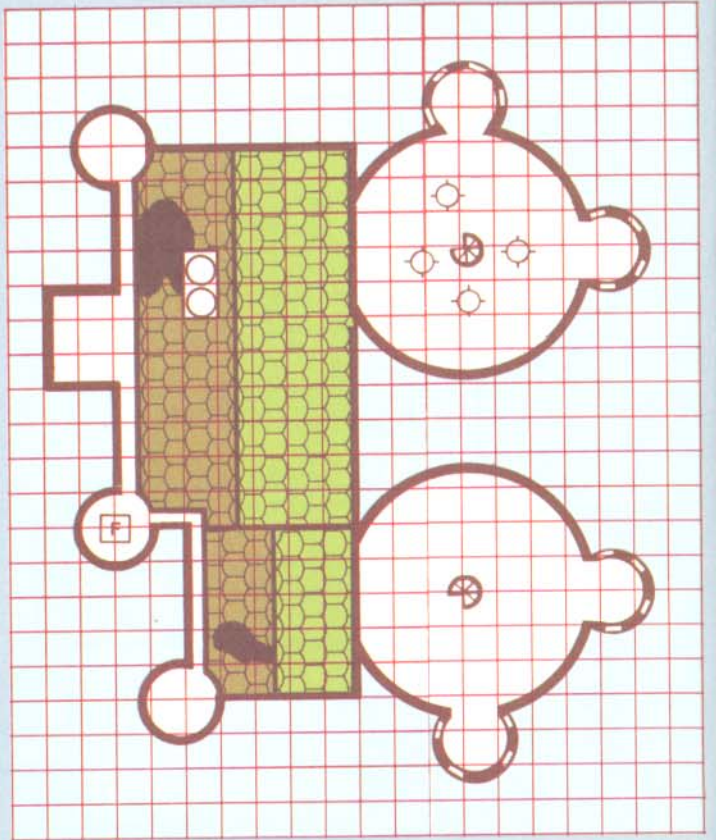



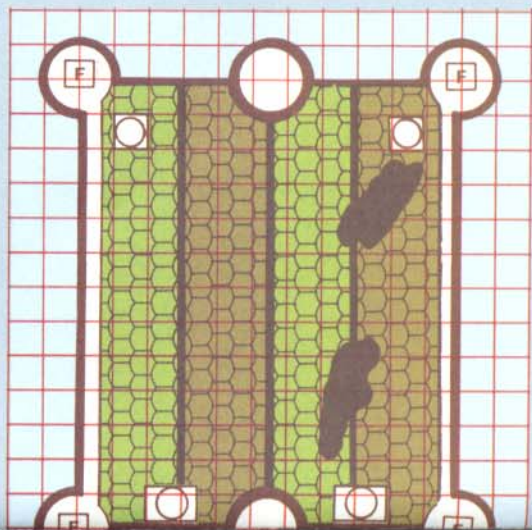
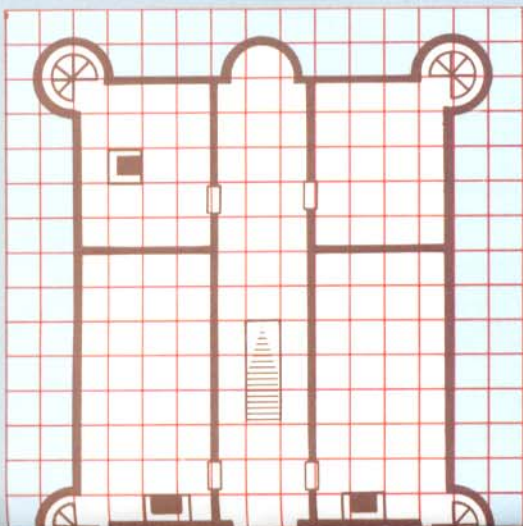
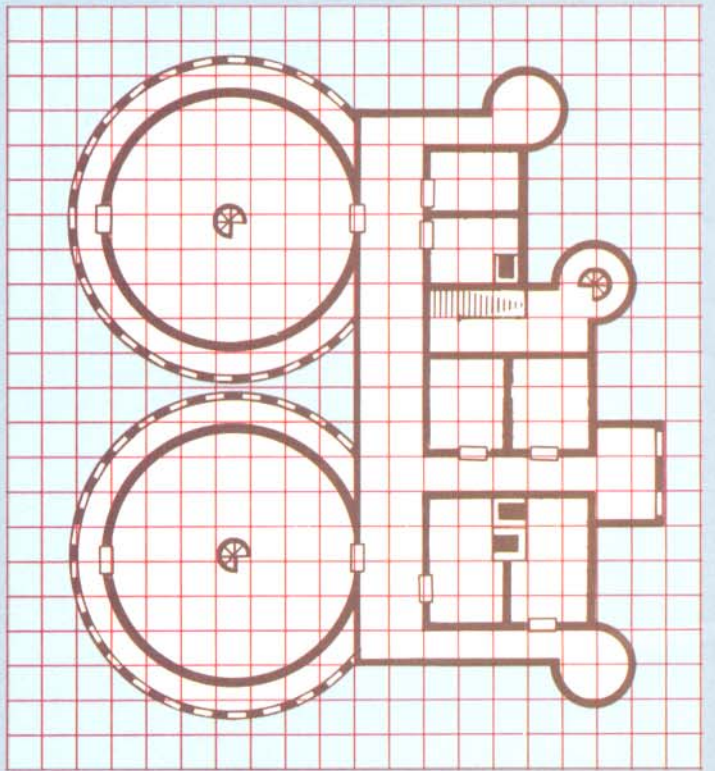
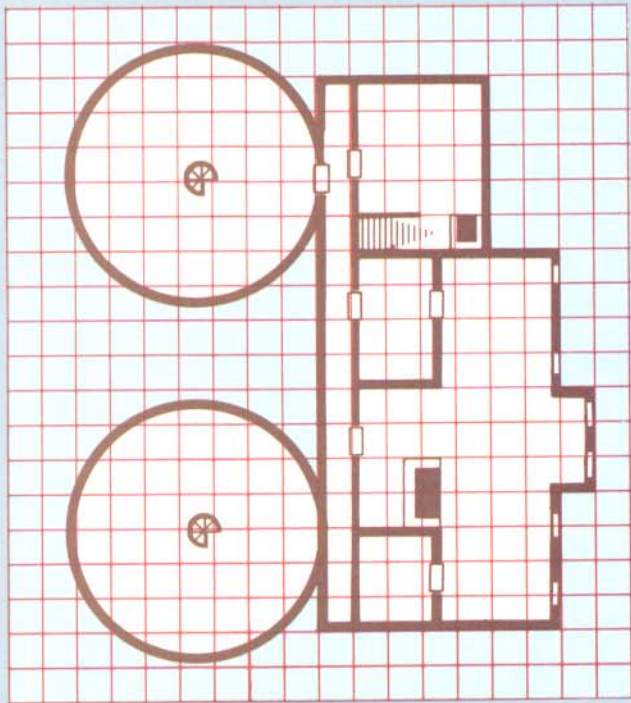

Atlas Car...

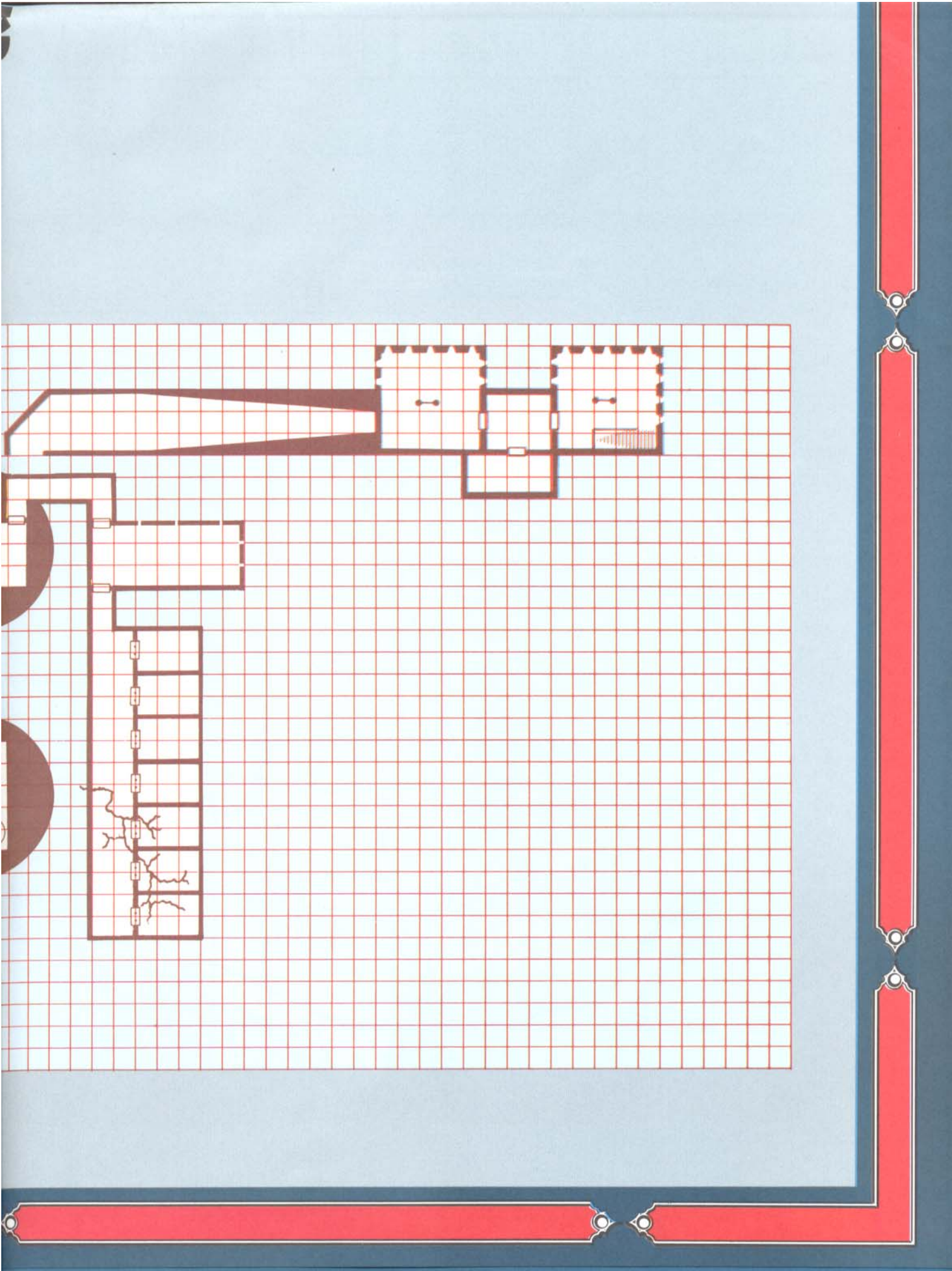



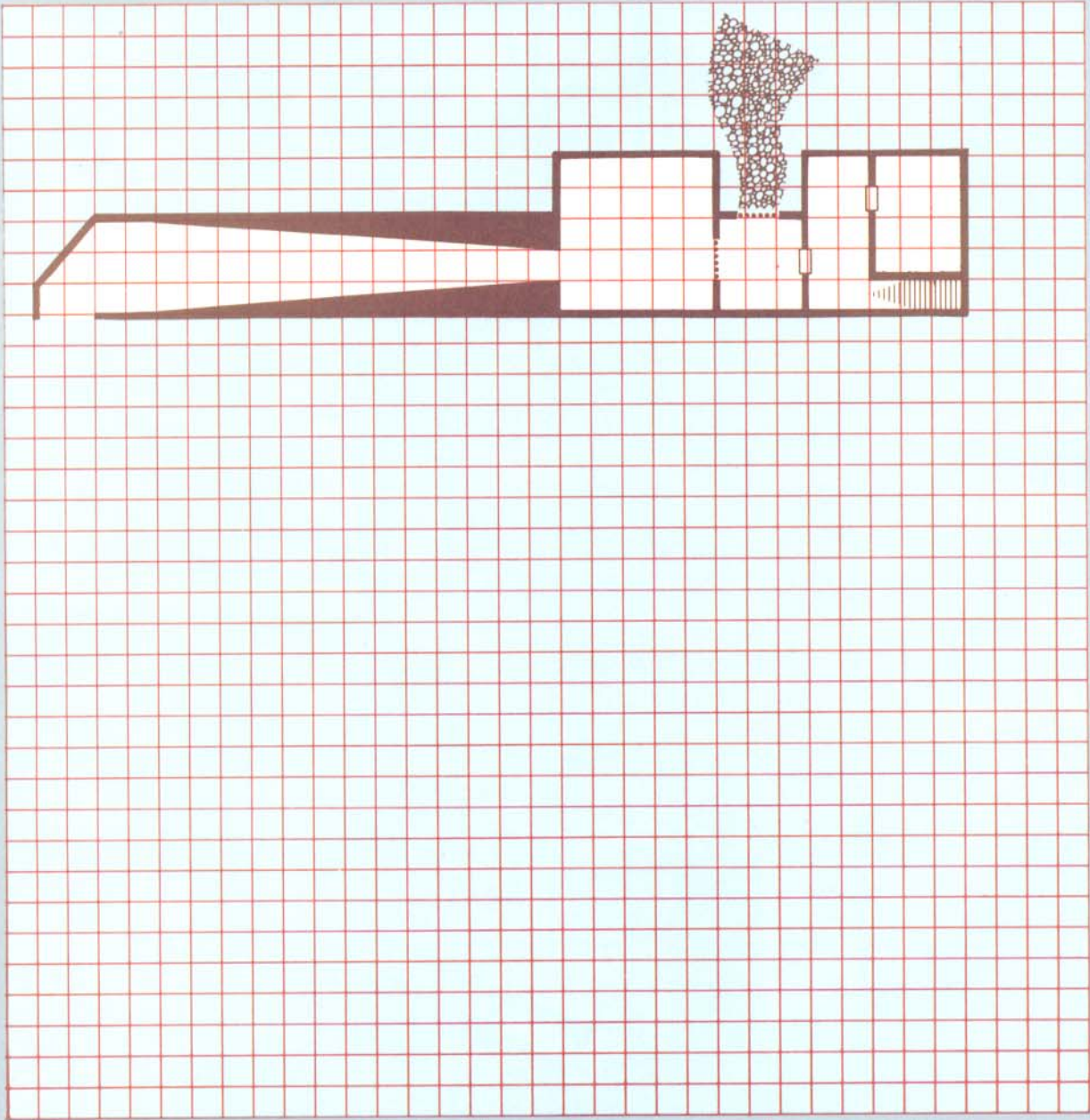





## CASTLES FORLORN

### Time Is Meaningless in Castle Tristenoira

**F**orlorn has long remained hidden in the shadows of notorious Barovia and Kartakass, yet the tiniest domain in the lands of the core is nearly as old as Ravenloft itself. This land is sick with evil, a twisted mockery of the place it once was. It is filled with creatures of despair who were drawn into the demiplane of dread. . . .

**W**ithin Castle Tristenoira lies oblivion. The crumbling keep slips in and out of time, carrying its unwary explorers across the centuries, where they may be abandoned to the cold winds of eternity—and to the ghosts in the castle! Spirits both innocent and guilty haunt the timeless passages, whispering tales of murder and vengeance. Escape is for the lucky . . . or the hopelessly mad.

The *Castles Forlorn* boxed adventure set provides the DUNGEON MASTER™ with a rich and complex domain in which to set a campaign of any size and duration. It

includes a 96-page sourcebook, *The Weeping Land*, which reveals the complete history of the domain and the strange and terrible lord who rules over it. Descriptions of the living and dead who call this lonely land home abound, as do details of the forbidding Tristenoira castle, where adventurers may spend an evening or an age.

After learning Forlorn's history of sorrow, the DM™ can lead player characters into *Melancholy Meetings*, a 32-page collection of encounters that provide adventure in every corner of the domain. Finally, only *Eve of Sorrows* remains, which is a 32-page assortment of mysteries and nightmares within the castle itself.

This deluxe boxed adventure set completes the portrait of Forlorn with a highly detailed, double-sided poster map of the castle, a poster map of the domain, and a special wall poster created by award-winning artist Robh Ruppel—all in full color.

ISBN 1-56076-645-X



9 781560 766452

52000&gt;



TSR, Inc.  
POB 756  
Lake Geneva  
WI 53147  
USA



TSR Ltd.  
120 Church End  
Cherry Hinton  
Cambridge CB1 3LB  
United Kingdom

\$20.00 U.S.

\$24.00 CAN.

£11.99 U.K.

ADVANCED DUNGEONS & DRAGONS, AD&D, and RAVENLOFT are registered trademarks owned by TSR, Inc.

DUNGEON MASTER, DM, and the TSR logo are trademarks owned by TSR, Inc.

©1993 TSR, Inc. All Rights Reserved. Printed in the U.S.A.